





Contents

1. Licence Agreements	5
2. System requirements	7
3. Catalogue numbers	7
4. Compatible Devices	8
4.1 Measuring / metering devices	8
4.2 Devices without measuring / metering data	9
4.3 Charging stations for electric vehicles	9
5. Languages available	10
6. Preliminary operations	11
7. Implementation	11
7.1 Installation	11
7.2 Use of the Modbus RS485 port of the Mini Web Server	12
7.3 Local settings	13
7.4 Connecting the device to a PC - Programming	13
7.5 Web Server default settings	13
7.6 LAN configuration of the computer	14
7.7 Configuration of the Web Server	16
7.7.1 Network settings - Personal configuration	16
7.7.2 Access with new Network parameters	19
7.8 Modbus settings	22
7.9 Data and Time settings	24
7.10 Update of the Web Server	26
7.10.1 Update procedure	27
7.11 Changing of the Web Server's language	28
7.11.1 Changing of the default language	28
7.11.2 Changing of the display language	29
7.12 Remote settings	30
7.13 Connection schemes - Normal Use	30
7.14 LAN configuration of the computer - Automatic IP address	31
7.15 Configuration of the electric installation in the Web Server - "System configuration"	33
7.15.1 Gateways and Devices configuration	35
7.15.1.1 Using "Local" gateway	36
7.15.1.2 Creating and Saving new Gateways	37
7.15.1.3 Creating and Saving of "Physical" Devices	38
7.15.1.4 Advanced options	46
7.15.1.5 System functions	49
7.15.2 Loads, Groups and Panel boards configuration	51
7.15.2.1 Panel boards	52
7.15.2.2 Loads	53
7.15.2.3 Measure groups	54
7.15.2.4 System functions	55
7.15.3 Bill of Consumptions	57
7.15.4 Configuration of the data sample rate	58
7.15.5 Green'Up configuration	60
7.15.5.1 Management configuration	61
7.15.5.2 Priority Stations	65
7.15.6 Master/Slave function	66
7.15.6.1 Activation of the function	67
7.15.6.2 Creating and Saving of "Virtual" Gateways and Devices	68

Contents

8. Use	72
8.1 Access	72
8.1.1 Access rights	72
8.1.2 Creating a new User	73
8.1.3 Changing of the access rights	74
8.1.4 Logout procedure	75
8.2 Data display pages	76
8.2.1 My panel board	76
8.2.2 Consumptions: data & diagraph.	81
8.2.2.1 Grand Total	83
8.2.2.2 Partial - Groups and load type	85
8.2.2.3 Compare	86
8.2.2.4 Details	87
8.2.2.5 Advanced histograms display	88
8.2.3 Link Function	91
8.3 Green'Up	93
8.3.1 Details	94
8.3.2 Management	95
8.4 Historical of consumptions	97
8.4.1 CSV files options	97
8.4.2 Access to CSV files	98
8.4.3 Management of CSV files	100
8.4.3.1 "devices" folder	101
8.4.3.2 "energy" folder	102
8.4.3.3 "eqcheck" folder	102
8.4.3.4 "gas" folder	102
8.4.3.5 "overall total" folder	102
8.4.3.6 "settings" folder	103
8.4.3.7 "water" folder	103
8.5 Reports & data download	104
8.5.1 Data download	104
8.5.2 Reports	108
8.6 Pushing e-mail and notifications	112
8.6.1 E-mail settings	112
8.6.2 Telegram	114
8.6.3 Automatic reports	116
8.6.4 Alerts settings	119
8.7 Reports: alarms	121
9. Backup and Restore	122
9.1 Backup procedure	122
9.2 Restore procedure	124
10. Network type and access mode	126
10.1 LAN/Intranet	126
10.1.1 Ports	126
10.2 WAN/Internet	127
10.2.1 Ports	128
11. FAQ	129
11.1 Access problems	129
11.2 Telegram problems	129
11.3 E-mails sending test problems	129

1. License Agreements

IMPORTANT:

PLEASE READ THE TERMS AND CONDITIONS OF THIS LICENSE AGREEMENT CAREFULLY BEFORE USING THE SOFTWARE (AS DEFINED BELOW).

THIS IS A LICENSE AGREEMENT BETWEEN YOU AND LEGRAND SNC (LEGRAND) WHICH IS LOCATED 128 AVENUE DU MARECHAL DE LATTRE DE TASSIGNY 87045 LIMOGES CEDEX.

BY OPENING THIS PACKAGE, BREAKING THE SEAL, CLICKING THE "I AGREE" OR "YES" BUTTON OR OTHERWISE INDICATING ASSENT ELECTRONICALLY, OR LOADING THE SOFTWARE, YOU AGREE TO THE TERMS AND CONDITIONS OF THIS LICENSE AGREEMENT.

IF YOU DO NOT AGREE TO THESE TERMS AND CONDITIONS, MAKE NO FURTHER USE OF THE SOFTWARE, AND CONTACT YOUR VENDOR OR LEGRAND CUSTOMER SERVICE FOR INFORMATION ON HOW TO OBTAIN A REFUND OF THE MONEY YOU PAID FOR THE SOFTWARE IN ACCORDANCE WITH THE GENERAL CONDITIONS OF SALE OF LEGRAND.

1. DEFINITIONS

"Software" means:

(a) all of the contents of the files of the software delivered either with a file and a key ("Energy Management Software") either with a Web server ("Energy Web Server")

(b) related explanatory written materials or files ("Documentation"), fonts and the packaging of the product

(c) upgrades, modified versions, updates, additions, and copies of the foregoing, provided to you by LEGRAND at any time (collectively, "Updates").

"Use" means to access, install, download, copy, or otherwise benefit from using the functionality of the Software

2. GENERAL USE OF THE SOFTWARE

2.1 License

This contract is a license Agreement.

LEGRAND grants you a right not exclusive and not transferable to use the Software according to the conditions and terms defined below.

2.2 Rights and obligations

You may:

- use one copy of the Software on a single computer. If a greater number of copies and/or number of computers is specified within the Documentation or the applicable transaction documentation from the authorized distributor or reseller from which you obtained the Software, you may use the Software in accordance with such specifications;
- make one copy of the Software for back-up or archival purposes, or copy the Software onto the hard disk of Your computer and retain the original for back-up or archival purposes;
- use the Software on a network, provided that you have a licensed copy of the Software for each computer that can access the Software over that network;

1. License Agreements (continued)

2.2 Rights and obligations (continued)

- permanently transfer all of your rights in the Software granted under this License Agreement to another person or entity, provided that you retain no copies of the Software and the transferee agrees to the terms of this License Agreement. Partial transfer of your rights under this License Agreement shall not be permitted. For example, if the applicable documentation grants you the right to use multiple copies of the Software, only a transfer of the rights to use all such copies of the Software would be valid;
- use the Software in accordance with any additional permitted uses which may be set forth below.

You may not, nor may you permit any other person to:

- sublicense, rent or lease any portion of the Software;
- reverse engineer, decompile, disassemble, modify, translate, make any attempt to discover the source code of the Software or create derivative works from the Software;
- use the Software as part of a facility management, timesharing, service provider or service bureau arrangement;
- use the Software in any manner that is not permitted pursuant to this License Agreement.

3. COPYRIGHT

The Software is the property of LEGRAND or his licensors and is protected by law, including without limitation the copyright laws of the United States and other countries, and by international treaty provisions.

4. LIMITED WARRANTY

The Warranty of the General Conditions of Sale of LEGRAND will apply.

LEGRAND guarantees the smooth running of this software only with the use of products LEGRAND. He cannot be held responsible in case of malfunction due to the use of products others than products LEGRAND.

5. LIMITATIONS OF LIABILITY

LEGRAND cannot be held liable for any damages of any kind, including without limitation any consequential, operating loss, data loss, malfunction of other softwares installed on your computer or any lost profits resulting of the impossibility to use the software, even if LEGRAND has been aware of the possibility of such damage.

6. TERMINATION

LEGRAND has the right to terminate this Agreement by rights immediately by a written notification if you fail to comply with any term of this Agreement.

Upon termination of the license, you accept to destroy all copies of the Software and his Documentation.

7. GOVERNING LAW

This Agreement will be governed by French Law.

In the event of issues relating to the construction, validity and/or execution of this agreement the Parties undertake to find an amicable settlement.

Failing such a settlement the dispute will come under the competence of French Courts, namely the Tribunal de Grande Instance de Paris.

2. System requirements

Display possible on:

- PC: (Device, Web Browser)
 - Firefox : version 50 and following (v50.0+)
 - Chrome : v55.0+
 - Safari : v10.0+
 - Opera : v53.0+
- Tablet: (Device, Operating system, Web Browser)
 - iPad (all versions), iOS 10+, Safari
 - Android v6.0+, Chrome v55.0+
- Smartphones: (see User Guide)

3. Catalogue numbers

4 149 47: "Mini Energy Web Server 10"

- Management up to 10 Modbus addresses or 10 pulse counters

4 149 48: "Mini Energy Web Server 32"

- Management up to 32 Modbus addresses or 32 pulse counters

Software version 3.7.1

4. Compatible devices

4.1 Measuring / metering devices

- Range **EMDX³**
 - Multifunction measuring devices:
 - Modular - Cat.Nos **0 046 76, 4 120 51**
 - Access - Cat.Nos **0 146 68, 4 120 52**
 - Premium - Cat.No **0 146 69, 4 120 53**
 - Energy counters RS485:
 - Single-phase direct connection - Cat.Nos **0 046 77** and **4 120 68** (Standard), **0 046 79** (MID)
 - Three-phase direct connection - Cat.Nos **0 046 80** (Standard), **0 046 83** (MID), **4 120 74** (Standard), **4 120 75** (MID)
 - Three-phase connection with CT - Cat.Nos **0 046 84** (Standard), **0 046 86** (MID)
 - Energy counters pulse output (via the Concentrator Cat.Nos **4 149 26, 4 120 65** or **0 046 87**):
 - Single-phase direct connection - Cat.Nos **0 046 70/72/81** (Standard), **0 046 78** and **4 120 69** (MID)
 - Three-phase direct connection - Cat.Nos **0 046 73** (Standard), **046 82** (MID)
 - Three-phase connection with CT - Cat.Nos **0 046 74** (Standard), **0 046 85** (MID)
- Range **EMS CX³**
 - Multifunction measuring devices:
 - Single-phase connection via Rogowski coil - Cat.No **4 149 19**
 - Three-phase connection via Rogowski coil - Cat.No **4 149 20**
 - Three-phase connection with CT - Cat.No **4 149 23**
 - State and Control modules:
 - Signalling Auxiliary Contact (CA + SD) - Cat.Nos **4 149 29**
 - Universal State Module - Cat.Nos **4 149 30**
 - State & Control Module for Latching relays and Contactors - Cat.Nos **4 149 31**
 - Universal Control Module - Cat.Nos **4 149 32**
 - via Modbus RS485/EMS CX³ interface - Cat.No **4 149 40**
- Range **DX³**
 - RCD add-on module with integrated counting - Cat.Nos **4 106 57/58** and with integrated measuring - Cat.No **4 106 59**
 - via the communication module Cat.No **4 210 75**
- Range **DPX³**
 - **DPX³ 250 electronic, DPX³ 630 electronic, DPX³ 1600 electronic only** versions with **integrated measurement unit**
 - via the communication module Cat.No **4 210 75**
- Range **DMX³** with protection unit – touchscreen (Cat.Nos **0 288 03/04**)
 - via the communication module Cat.No **0 288 05**

- Gas counters
 - Any device with pulse output (via the Concentrator Cat.Nos **4 149 26***, **4 120 65*** or **0 046 87***)
- Water counters
 - Any device with pulse output (via the Concentrator Cat.Nos **4 149 26***, **4 120 65*** or **0 046 87***)

* **Note:** Pulse Concentrator must be properly programmed to be compatible with the type of counter (Refer to the pulse concentrator's technical documentation)

- "Generic" Measurement/Counting Devices with Modbus RS485 output
 - Any "other manufacturers" meter or counter with Modbus RS485 output, **limited only to positive active energy**

4.2 Devices without measuring / metering data

- Range **DPX³**
 - **DPX³ 250 electronic, electronic with integrated RCD and thermal-magnetic with integrated RCD**
 - **DPX³ 630 electronic**
 - **DPX³ 1600 electronic**
 - via the communication module Cat.No **4 210 75**
- Range **DMX³** with protection unit – LCD screen (Cat.No **0 288 00/01/02**)
 - via the communication module Cat.No **0 288 05**
- Range **RS485 power supervision system** devices
 - Signalling and control interface - Cat.No **0 261 36**
 - Module programmable output - Cat.No **0 288 12**

4.3 Charging stations for electric vehicles

- Range **Green'Up™ "Premium" (New range)**
 - Single-phase stations - Mode 3 (Cat.Nos **0 590 00/01**)
 - Single-phase stations - Modes 2 and 3 (Cat.Nos **0 590 03/04/10/11/12/13/30/35/41/42/43/44**)
 - Three-phase stations - Mode 3 (Cat.Nos **0 590 02**)
 - Three-phase stations - Modes 2 and 3 (Cat.Nos **0 590 14/15/48/49**)
 - via the communication kit Cat.No **0 590 56** (1 Modbus address for a single side station, 2 Modbus addresses for a double side station)
- Range **Green'Up™ (Old range)**
 - "One-side" Stations, single-phase without RFiD (Cat.Nos **0 590 31/33/37/76/91/93**)
 - "Two-sides" Stations, single-phase without RFiD (Cat.Nos **0 590 32/34/38/77/78**)
 - "One-side" Stations, single-phase with RFiD (Cat.Nos **0 590 61/63**)
 - "Two-sides" Stations, single-phase with RFiD (Cat.Nos **0 590 40/57/58**)
 - "One-side" Stations, three-phase without RFiD (Cat.Nos **0 590 45/94/95**)
 - "Two-sides" Stations, three-phase without RFiD (Cat.Nos **0 590 96/97**)
 - "One-side" Stations, three-phase with RFiD (Cat.Nos **0 590 46/64/65**)
 - "Two-sides" Stations, three-phase with RFiD (Cat.Nos **0 590 47/66/67**)

5. Languages available

Languages:

- 中国
- Deutsch
- English
- Español
- Français
- Français (Belgique)
- Ελληνικά
- Italiano
- Nederlands (Belgie)
- Nederlands
- Polski
- Portuguese
- Русский

6. Preliminary operations

ATTENTION!

Before commissioning the installation we recommend you to verify on the legrand “e-catalogue” site if a software update is available.

Download the update file from the Legrand site to your computer. This file will be used to update the firmware.

(After downloading the update file follow the procedure detailed on pages 26 to 27 of this manual)

7. Implementation

7.1 Installation

Mini Web servers allow different installation types:

Type 1: Mini Web server is used as a Modbus/IP gateway (all Modbus RS485 devices are directly wired to the Web server).

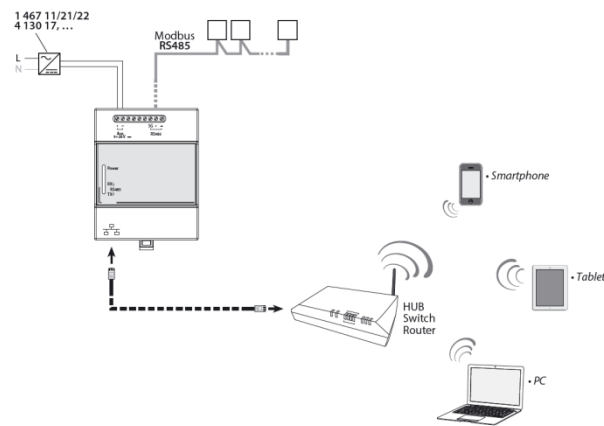

Type 2: Mini server is used as a Modbus/IP gateway (some RS485 devices are directly wired to the Web server) and as a Gateways IP “Concentrator”

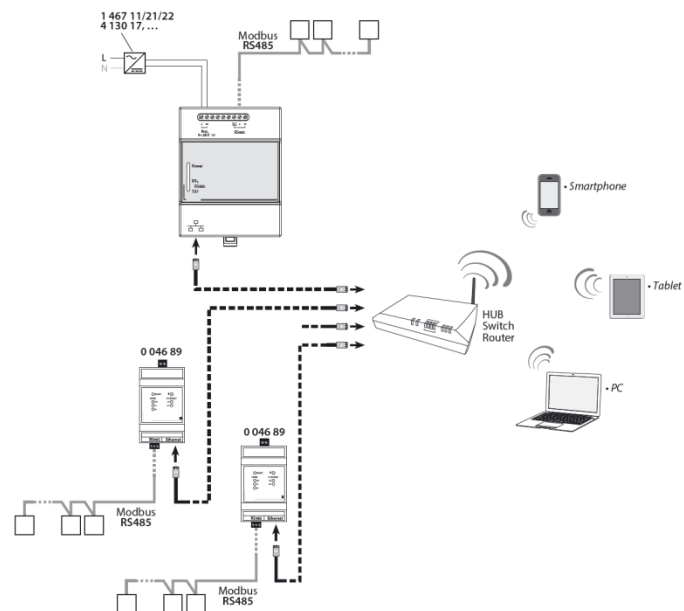

7.1 Installation (continued)

Type 3: Mini Web server is used as a Gateways IP “Concentrator” (All Modbus RS485 devices are wired only to Gateways 0 046 89, which then communicate with the Web Server).

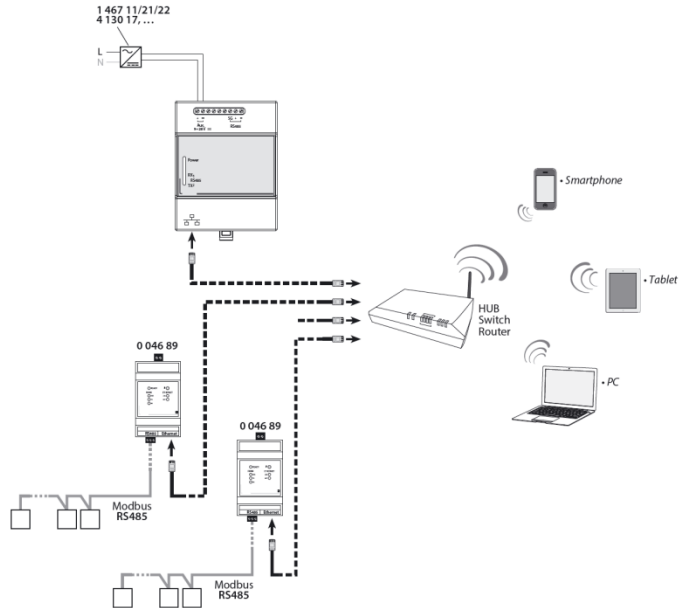

Note: all the IP devices must have a different IP address

7.2 Use of the Modbus RS485 port of the Mini Web Server

Wiring diagram

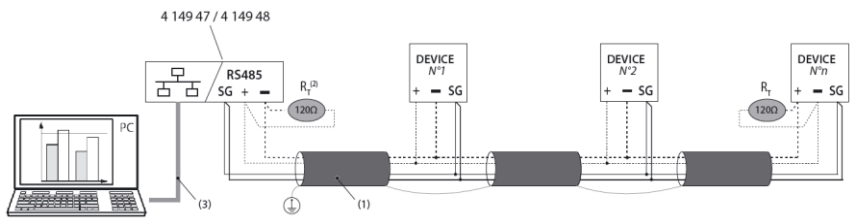

(1) RS485: Prescribed use of Cable Belden 9842, Belden 3106A (or equivalent) for a maximum length of 1000 m, or Category 6 cable (FTP or UTP) for a maximum length of 50 m;

(2) Resistance not furnished

(3) Ethernet: Cat. 6 (FTP/UTP)

7.3 Local settings

Local settings / configuration

- Procedure to configure the Web Server from a computer directly connected to it.

Materials required

- Mini Web Server's instruction sheet
- Mini Web Server's user manual
- PC with a web browser (Chrome, Firefox, etc.)

Note: The local settings must be made mandatorily by a computer

Useful Information

- IP network parameters for Web Server (use the [Parameters Table of the Mini Web Server](#))

7.4 Connecting the device to a PC - Programming

- Connect the Web Server directly to a PC by the Ethernet cable (is possible to pass through a switch)

Note: In this phase don't connect the Mini Web Server to other devices (Gateways, etc.) or to the Building Network

- Supply the Web Server

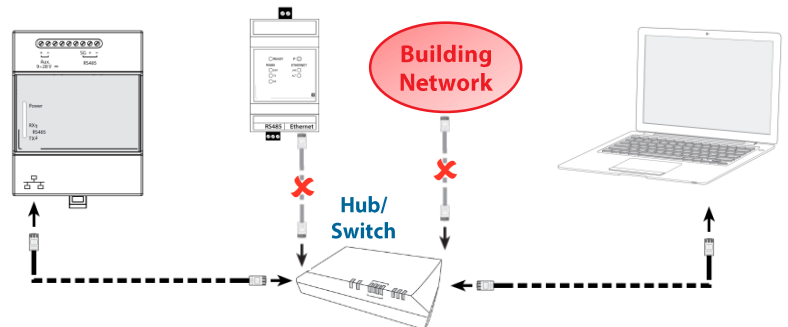

7.5 Mini Web Server default settings

- IP Address: 192.168.1.100
- Subnet Mask: 255.255.255.0
- Default Gateway: 192.168.1.1

Note: Mini Web Server and Gateway have the same default settings

7.6 LAN configuration of the computer

Follow the procedure:

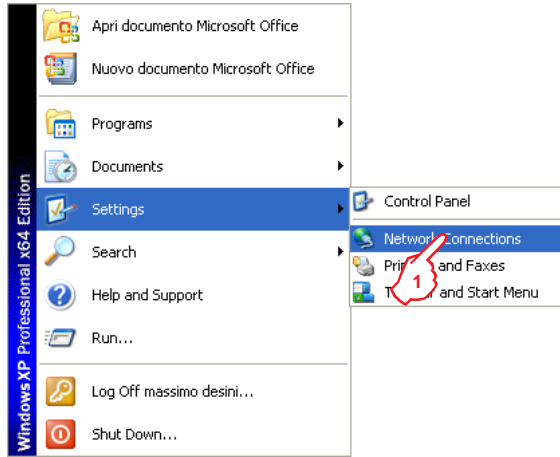

1. In the Start menu choose “Settings” then click “Network Connections”

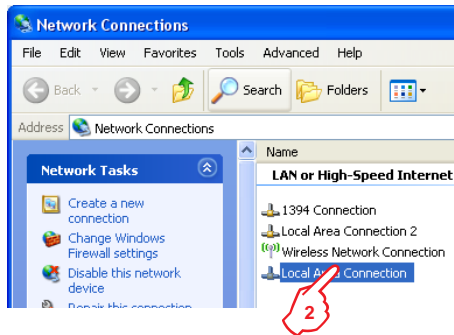

2. Click “Local Area Connection”

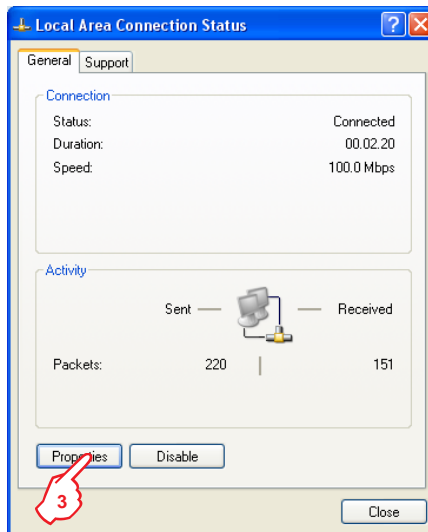

3. Click “Properties”

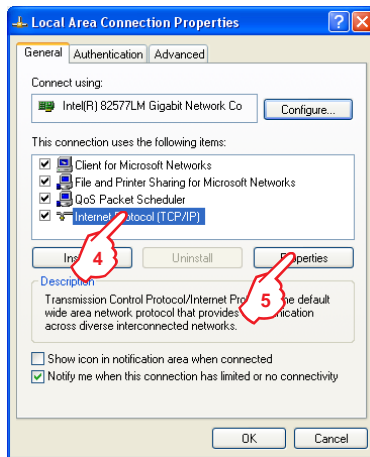

4. Click "Internet Protocol (TCP/IP)"
5. Click "Properties"

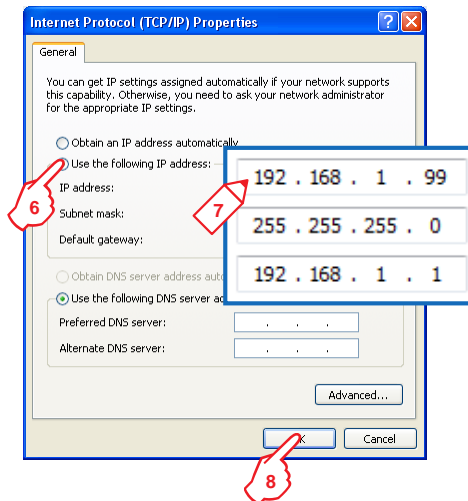

6. Click "Use the following IP address"
7. Enter the LAN parameters as shown
8. Click "OK" to confirm

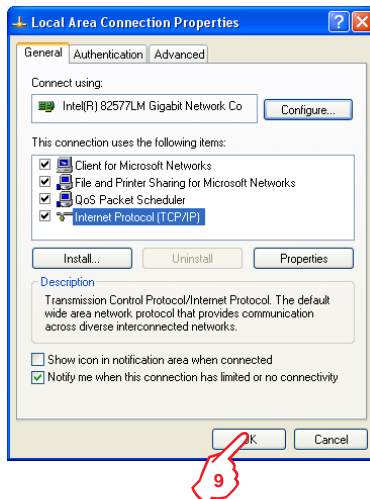

9. Click "OK" to confirm

7.7 Configuration of the Web Server

7.7.1 Network Settings - Personal configuration

To access to the Web Server, type the IP address **192.168.1.100** (default IP) in the web browser.



Web Server's Login page appears

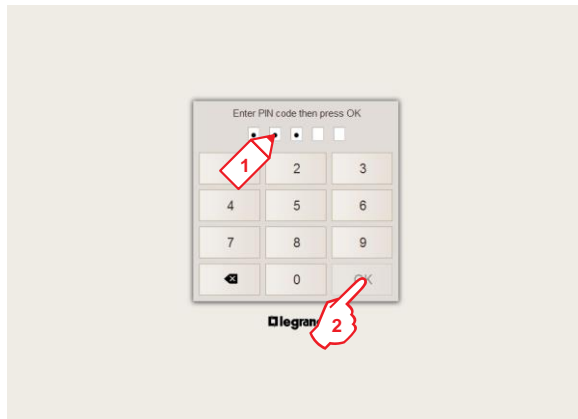

1. Type the access PIN code **99999** (default PIN)
2. Click "OK"



3. Type the access PUK code **00000 9999 00000** (default PUK)
4. Click "OK"

Web Server's Home page appears.

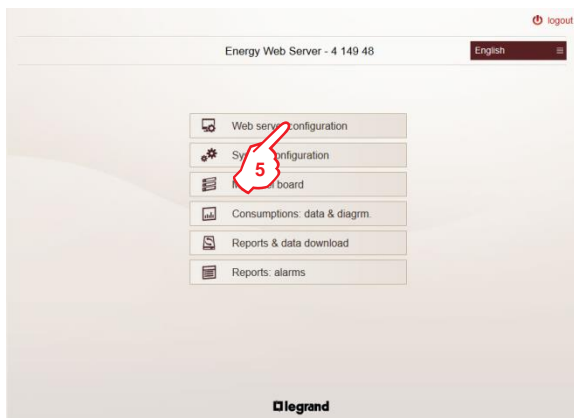

5. Click "Web Server configuration"

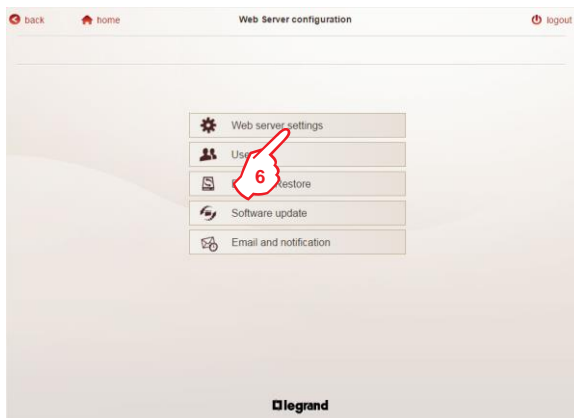

6. Click "Paramètres du Serveur web"

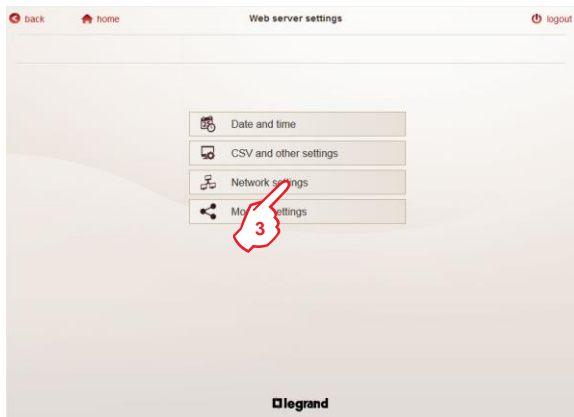

7. Click "Network settings" to configure the LAN properties of the Server

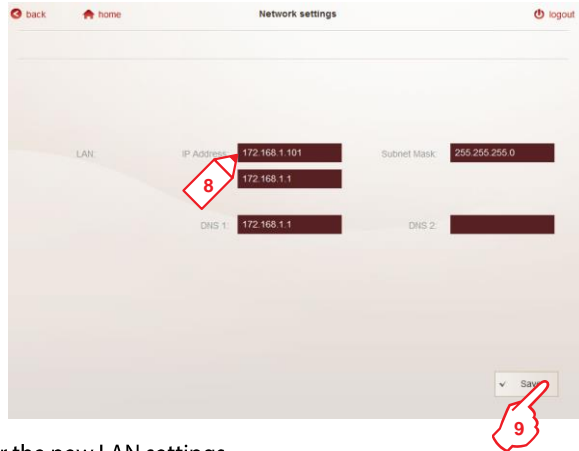

8. Enter the new LAN settings.

Example of IP network settings to configure on the Web Server

- IP Address: **172.168.1.101**
- Subnet mask: **255.255.255.0**
- Default gateway: **172.168.1.1**

9. Click "Save" **2 times** to confirm

Note: Now the Web server has new network parameters

7.7.2 Access with new Network parameters

- After changing of the Network parameters of the Server, it is necessary to configure manually an IP address compatible with the new IP address of the web server as shown below:

(in the example the server has the IP 172.168.1.101 → use 172.168.1.99)

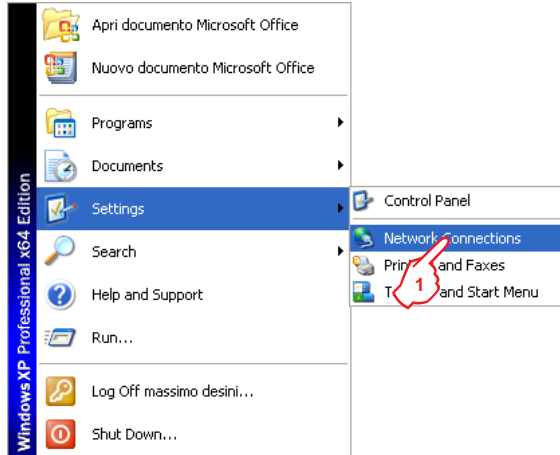

1. In the Start menu choose "Settings" then click "Network Connections"

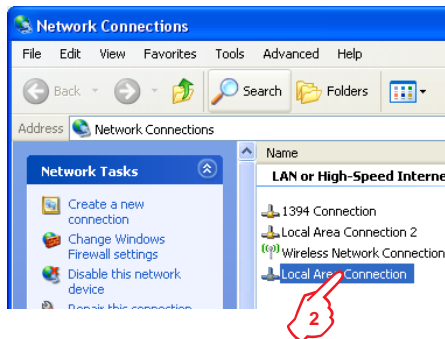

2. Click "Local Area Connection"

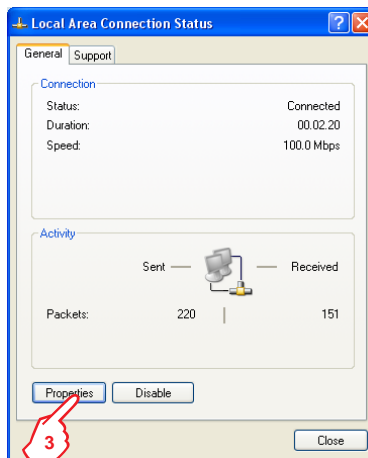

3. Click "Properties"

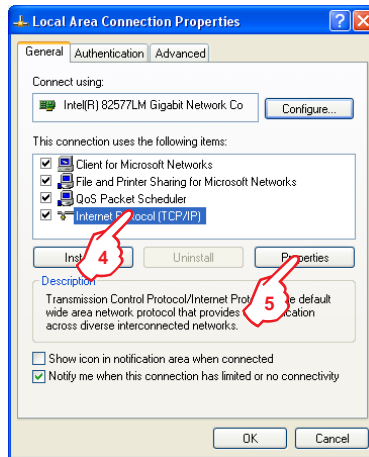

4. Click "Internet Protocol (TCP/IP)"
5. Click "Properties"

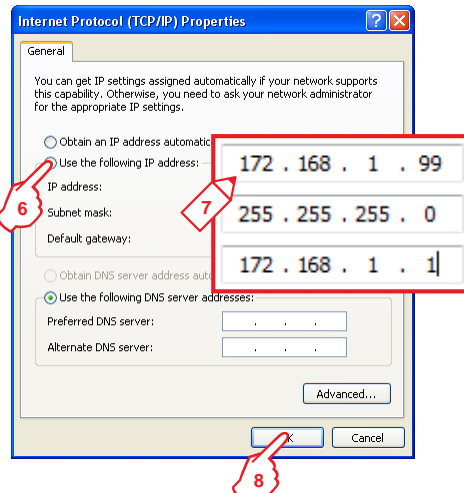

6. Click "Use the following IP address"
7. Enter the LAN parameters as shown
8. Click "OK" to confirm

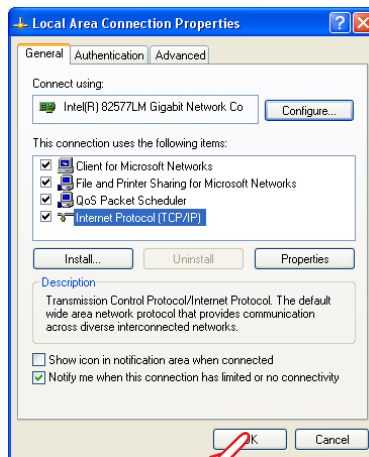

9. Click "OK" to confirm

To access to the Web Server, type the new IP address **172.168.1.101** (in the example) in the web browser.

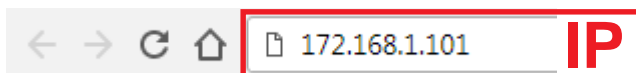

Web Server's Login page appears

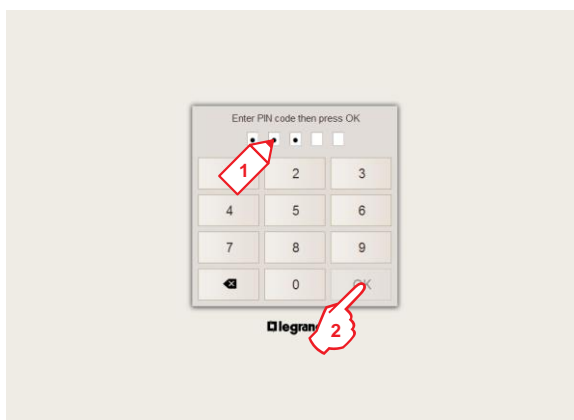

1. Type the access PIN code **99999** (default PIN)
2. Click "OK"

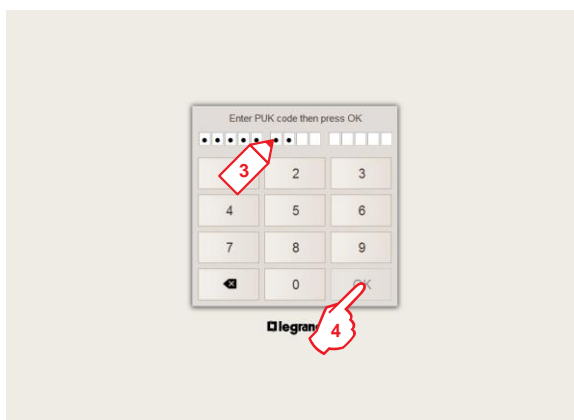

3. Type the access PUK code **00000 9999 00000** (default PUK)
4. Click "OK"

Web Server's Home page appears.

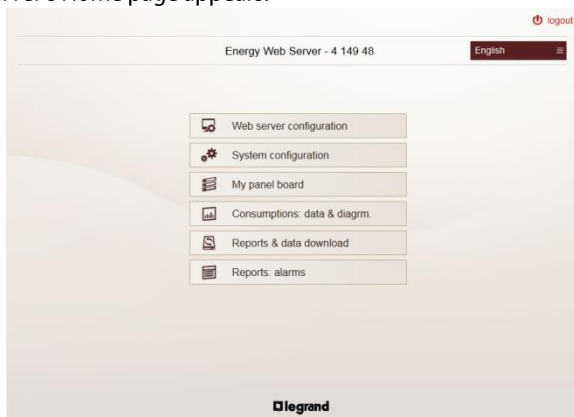

7.8 Modbus settings

In the Web Server's Home page

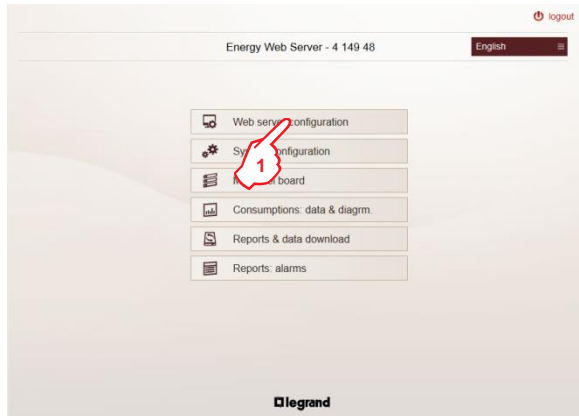

1. Click "Web Server configuration"

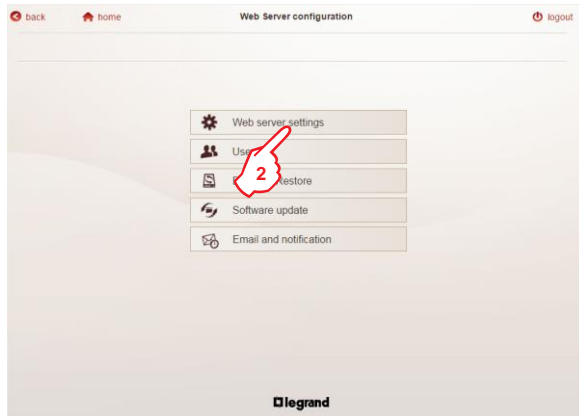

2. Click "Web server settings"

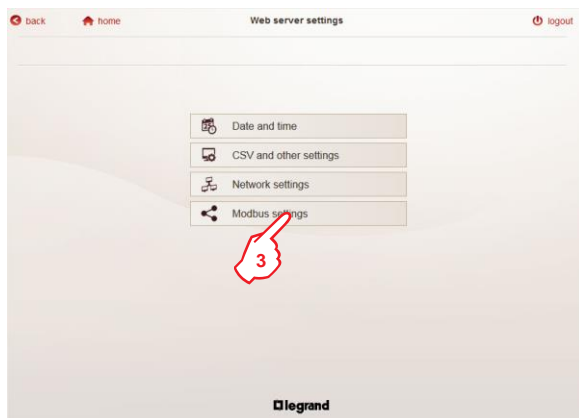

3. Click "Modbus settings" to set these parameters

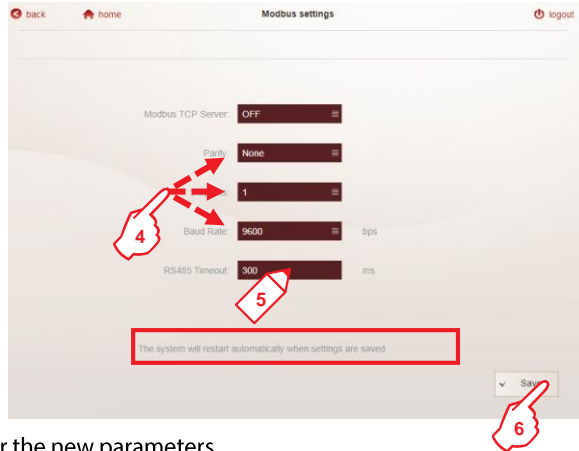

4. Enter the new parameters

- Parity
- Stop bits
- Baud Rate (bps)

5. Assign the RS485 Timeout

6. Click "Save" 2 times to confirm

Note 1: System will restart automatically when settings are saved.

Note 2: If you want to use Mini Web server also as a Modbus/IP gateway for other Servers (Mini or 255), you have to Enable ("ON") the Modbus TCP Server option and, as for the other parameters of this page, click "Save" 2 times to confirm.

Default parameters:

- Modbus TCP Server: OFF
- Parity: Even
- Stop bits: 1
- Baud Rate: 19200 bps
- RS485 Timeout: 300 ms

7.9 Data and Time settings

In the Web Server's Home page

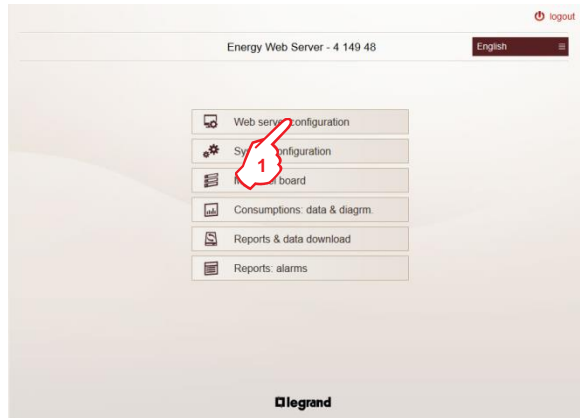

1. Click "Web Server configuration"

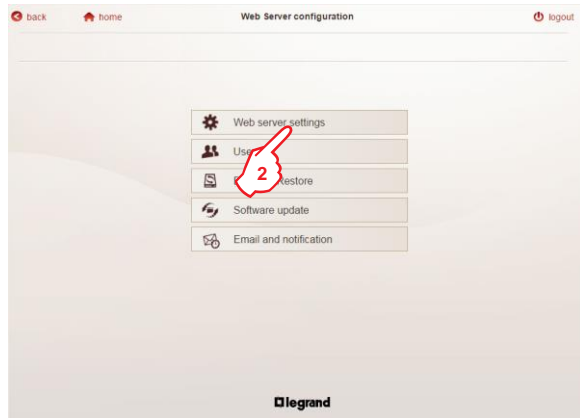

2. Click "Web server settings"

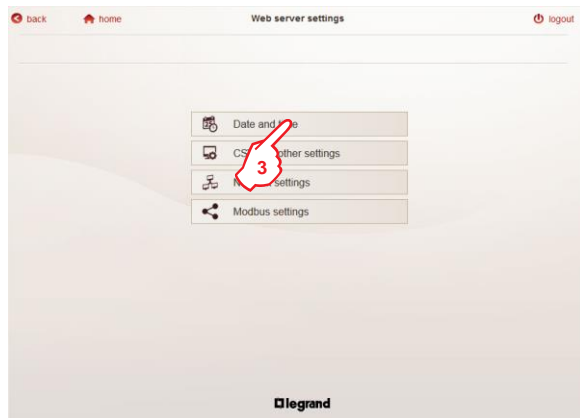

3. Click "Data and Time" to set these parameters

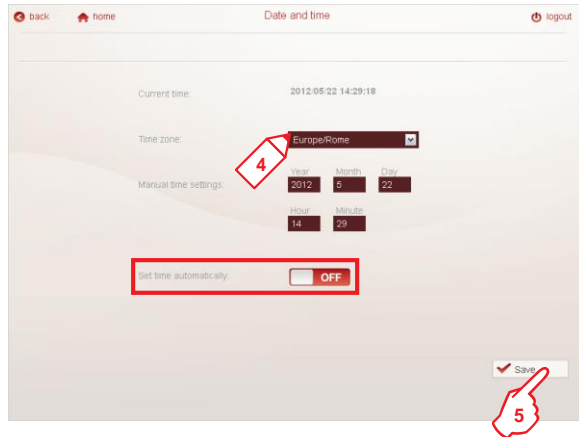

4. Enter the new parameters

- Time zone
- Date and time

5. Click "Save" to confirm

Note: Automatic time settings is set "OFF" per default. Enable this option only if you want that the Server is able to reach the clock from a Network time protocol (NTP) Server .

7.10 Update of the Web Server

Materials required:

- File downloaded from the "e-catalogue" legrand:

- Energy_Manager_Web_Server_414947_48_49_v_r_b.zip

 Energy_Manager_Web_Server = Product Name
414947_48_49 = Catalog number
v_r_b = Version of the embedded application

The folder .zip contains the following files:

- File ".jar": web server's update package

- Procedure for updating the Web Server: follow the procedure

Access to the Web server typing PIN and PUK codes

Web Server's home page appears

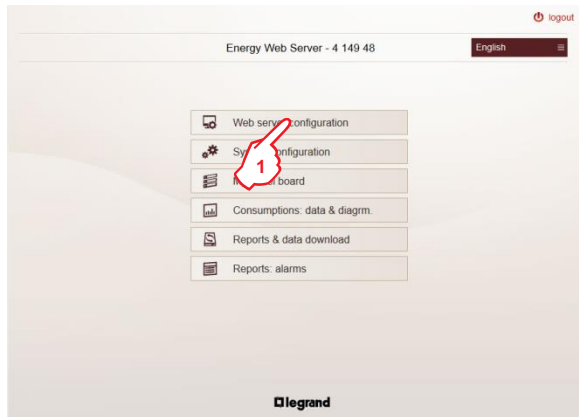

1. Click "Web Server configuration"

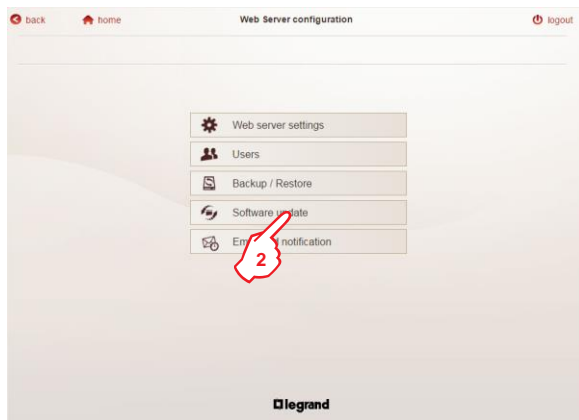

2. Click "Software update"

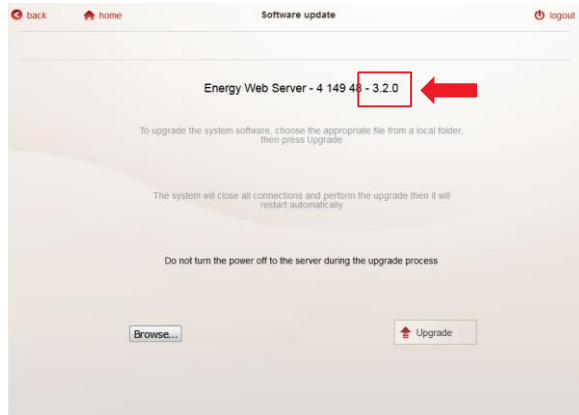

Compare the version of the installed software with the version of the file received from technical customer service. **Update the Software if the file version is more recent than the installed version.**

7.10.1 Update procedure

- From the compressed folder, extract on your computer the file: "wsmeasure.jar" for both catalogue numbers 4 149 47/48
Note: Mini web server automatically recognizes the type of license.
In the "Software update" page

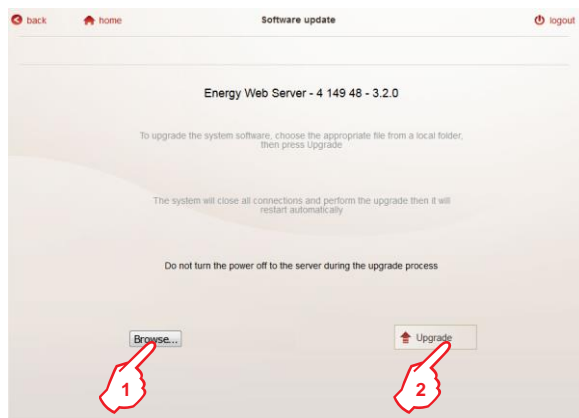

1. Click "Browse" to select the file ".jar" from your computer
2. Click "Upgrade"

IMPORTANT: please allow the time for the updating procedure: about 30 seconds

- Verify that the update has been done checking the software version on the "Software's update" page

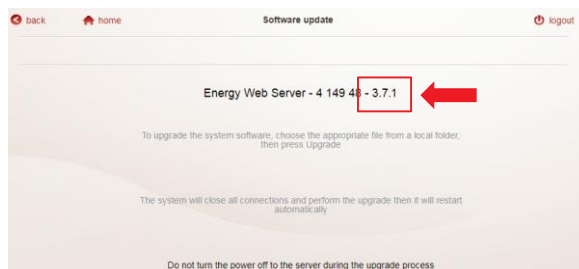

7.11 Changing of the Web Server's language

7.11.1 Changing of the default language

In the Web Server's home page

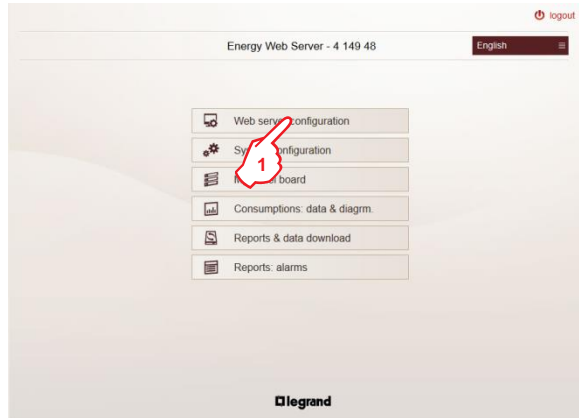

1. Click "Web Server configuration"

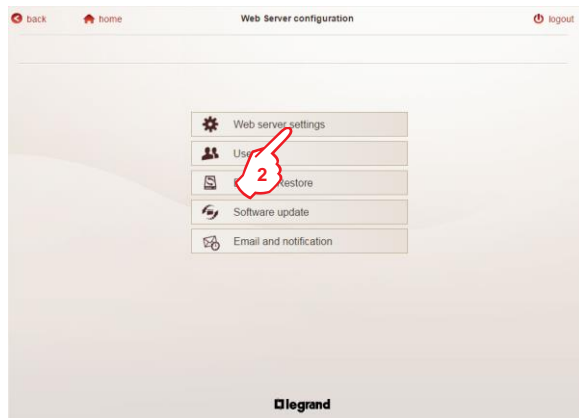

2. Click "Web server settings"

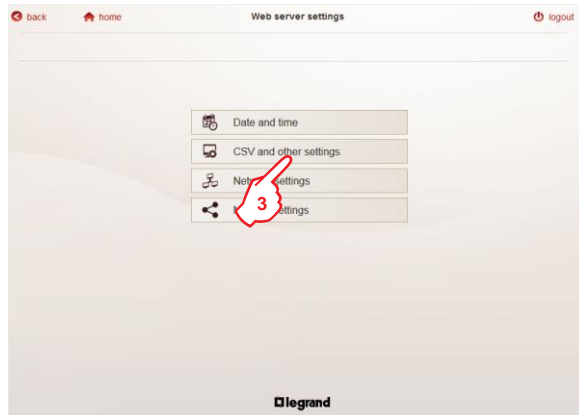

3. Click "CSV and other settings"

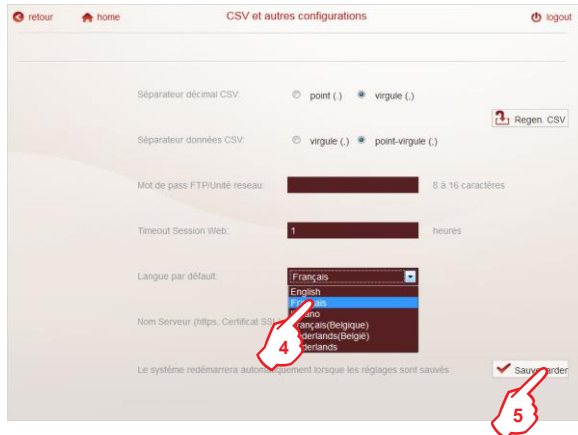

4. Choisir la langue parmi la liste des langues

5. Cliquer sur “Sauvegarder” pour confirmer

Note: la langue sera changée à la prochaine connexion.

7.11.2 Changing of the display language

In the Web Server’s Home page

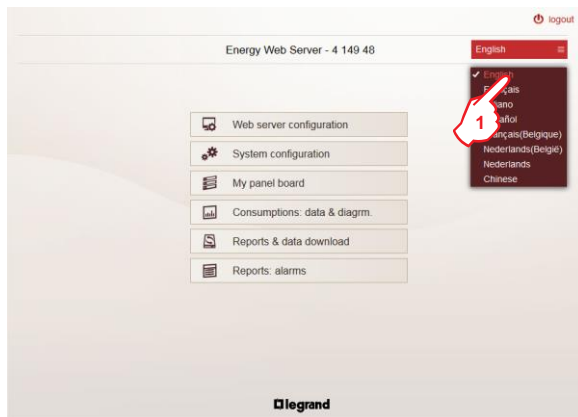

1. Choose the proper language from the list box.

Note: this operation doesn’t change the default language.

7.12 Remote settings

Settings / configurations of the electrical installation

- Procedure to configure the different devices on the web server

Materials required

- Mini Web Server's user manual
- A computer with a web browser (Chrome, Firefox, etc.)

Useful Information

- Network and RS485 bus parameters for Gateways and Devices (use the [Parameters Table of the Mini Web Server](#))

7.13 Connection schemes - Normal Use

Example of "Type 1" connection scheme

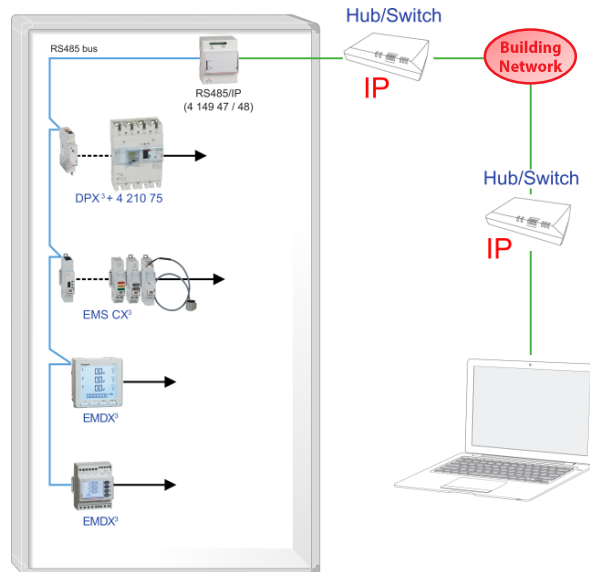

Example of "Type 3" connection scheme

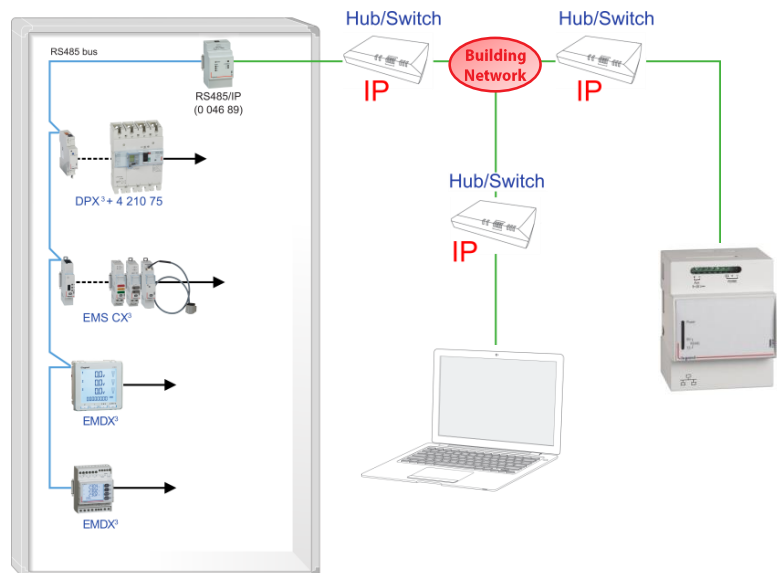

7.14 LAN configuration of the computer - Automatic IP address

Follow the procedure:

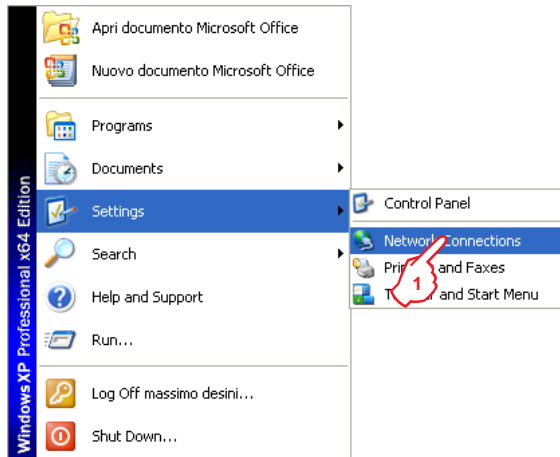

1. In the Start menu choose "Settings" then click "Network Connections"

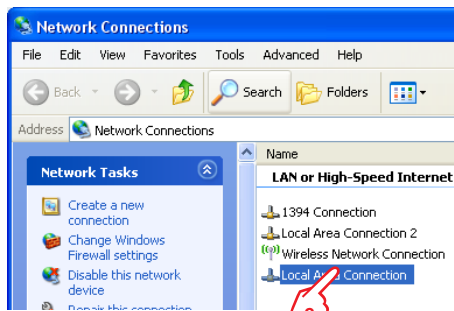

2. Click "Local Area Connection"

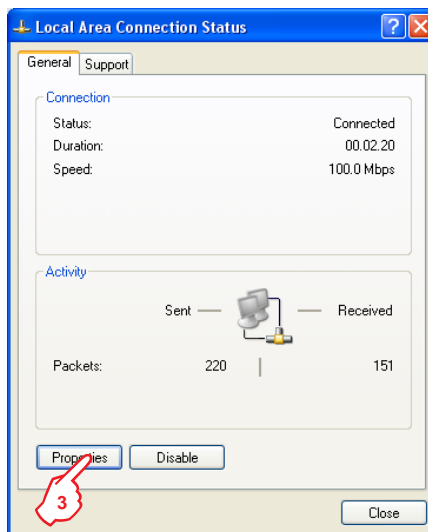

3. Click "Properties"

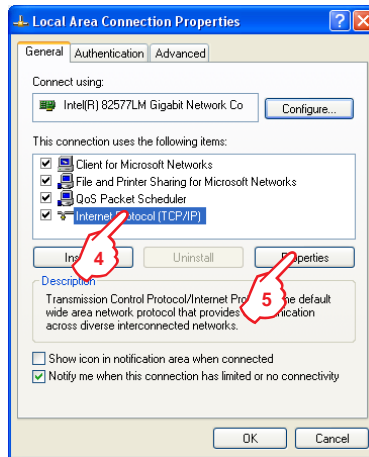

4. Click "Internet Protocol (TCP/IP)"
5. Click "Properties"

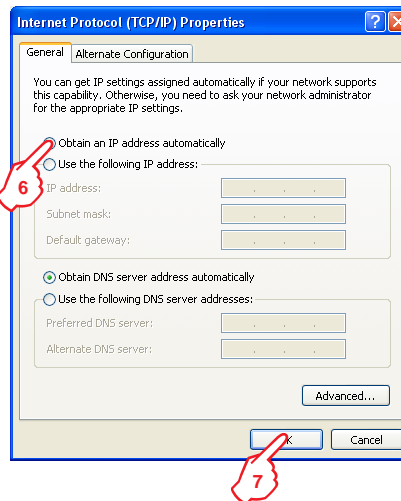

6. Click "Obtain an IP address automatically"
7. Click "OK" to confirm

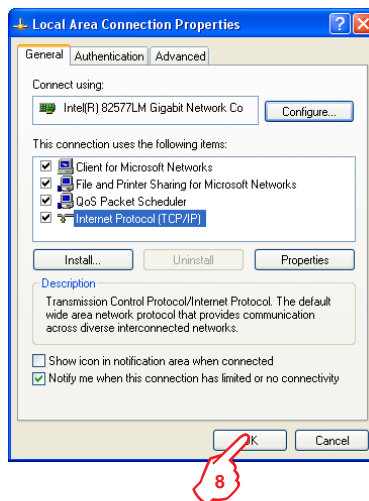

8. Click "OK" to confirm

7.15 Configuration of the electric installation in the Web Server - "System configuration"

Type the **set IP address** in the web browser.



Web Server's login page appears

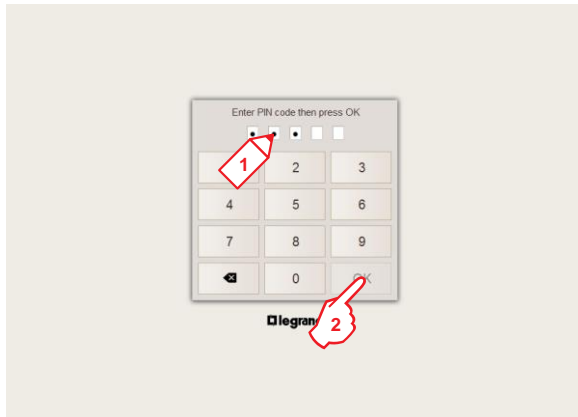

1. Type an access PIN code (ex. 88888 - default PIN)
2. Click "OK"

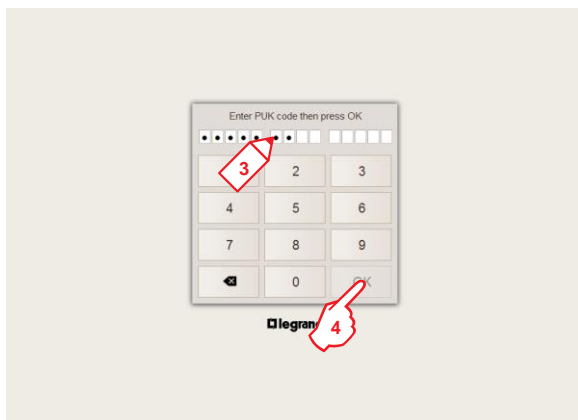

3. Type the access PUK code 00000 8888 00000 (default PUK)
4. Click "OK"

Web Server's Home page appears.

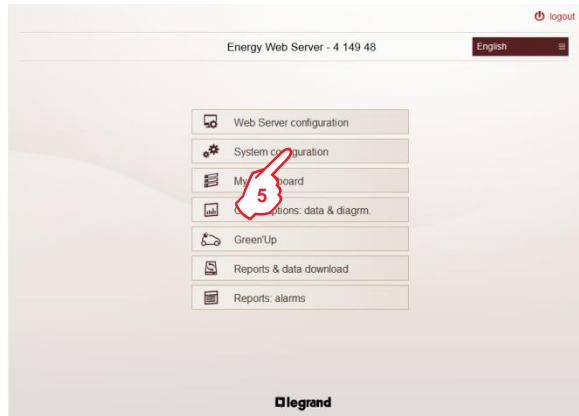

5. Click "System configuration"
System configuration page appears

- Configuration sequence:
 - Gateways and Devices configuration
 - Loads, groups and panel boards configurations
 - Bill of Consumptions configuration
 - Green'Up configuration

7.15.1 Gateways and Devices configuration

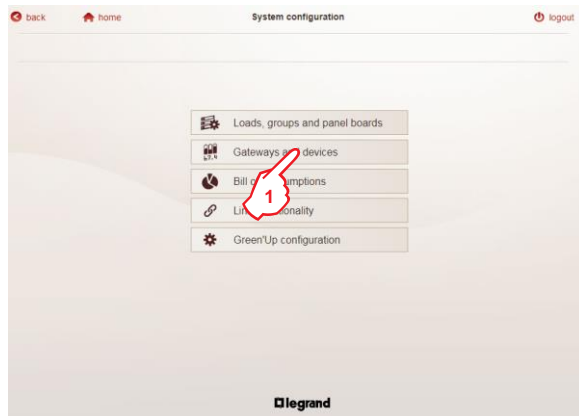

1. Click "Gateways and devices"
Gateway's settings page appears

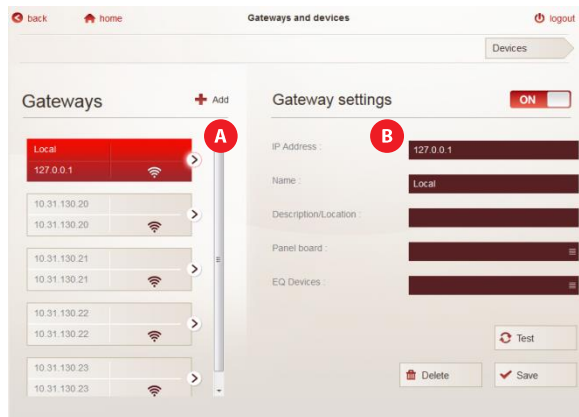

The page is divided into two sections:

section **A** is the "Gateways" area.

Note: at first connection, a pre-configured gateway is present in the list.

This gateway represent the function of "Modbus RS485/IP converter" of the Mini web server.

Name of the Gateway: Local

IP address: 127.0.0.1

Modbus RS485 settings: see §7.8

This gateway has all the properties of a standard gateways except for two aspects:

- the gateway IP address is fixed and can not be modified

- the gateway can not be deleted by any user

If Mini web server is used only as web server, simply put in OFF state the "Local" Gateway.

section **B** shows the "Gateway Settings" area, where the configuration fields for the selected gateway are available.

7.15.1.1 Using “Local” gateway

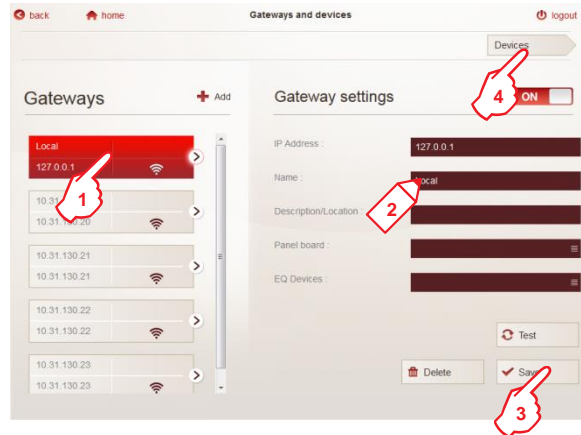

1. Select “Local” Gateway
 2. Assign/Modify the gateway parameters:
 - Name
 - Description/Location (optional parameter)
 3. Click “Save”
 4. Click “Devices” to configure the physical or virtual devices connected to the Gateway
- Device’s settings page appears

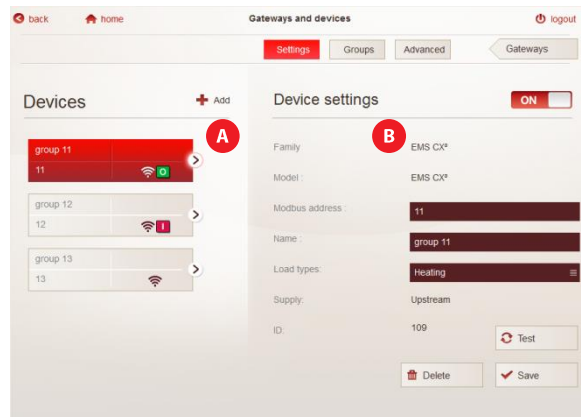

The page is divided into two sections:
 section **A** is the “Added Devices” area.
 section **B** shows the “Device Settings” area, where the configuration fields for the selected device are available.

7.15.1.2 Creating and Saving new Gateways

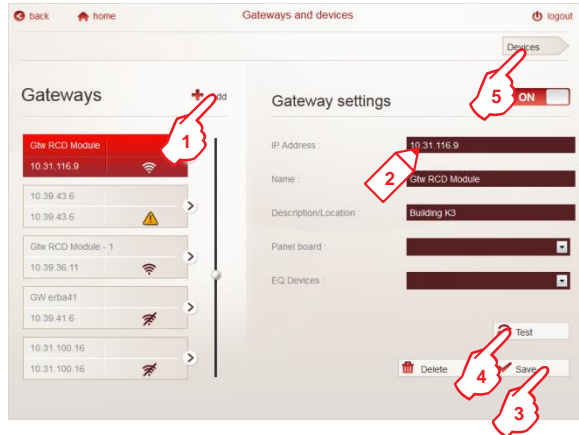

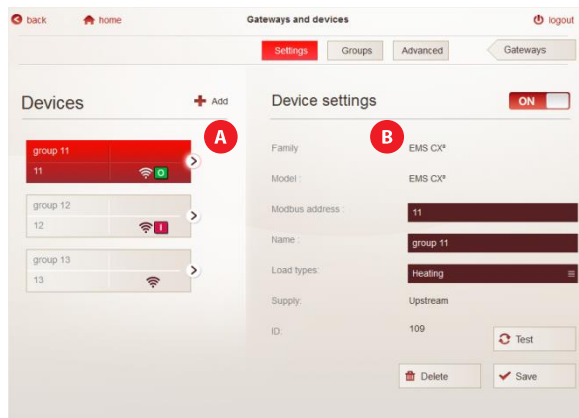

1. Click "Add"
 2. Assign the gateway parameters:
 - IP Address (required parameter)
 - Name (required parameter)
 - Description/Location (optional parameter)
 3. Click "Save"
 4. Click "Test" to verify the correct operation of the communication between the Web Server and the Gateway
 5. Click "Devices" to configure the physical or virtual devices connected to the Gateway
- Device's settings page appears



The page is divided into two sections:
 section **A** is the "Added Devices" area.
 section **B** shows the "Device Settings" area, where the configuration fields for the selected device are available.

• **Description of the Gateway selection button**



1. IP address assigned to the gateway
2. Name of the gateway
3. Gateway status
 -  On
 -  Off
 -  Communication error

7.15.1.3 Creating and Saving of “Physical” Devices

- Procedure for Measure device with RS485 output

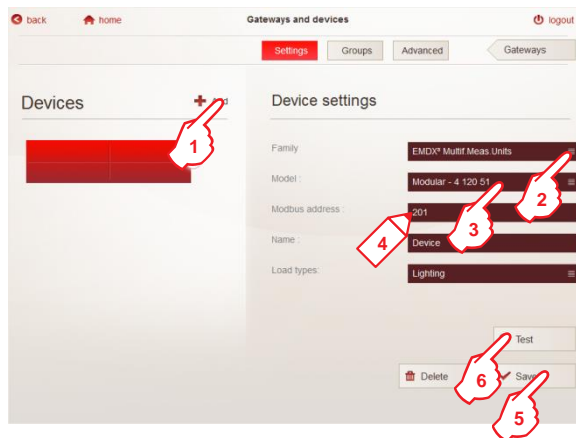

1. Click “Add”
 2. Choose the Device family from the families list
 3. Choose the Model from the models list
 4. Assign the Device parameters:
 - Modbus address (required parameter)
 - Name (required parameter)
 - Load type (optional parameter)
 5. Click “Save”
 6. Click “Test” to verify the correct operation of the communication between the Device and the Gateway
- Repeat the operations 1. ⇒ 6. to add more devices

Note: for devices 0 261 36 and 0 288 12, there is a menu for customizing the description label of inputs (for 0 261 36) and outputs (for 0 261 36 and 0 288 12) through the “Advanced” button.

- Procedure for EMS CX³ modules

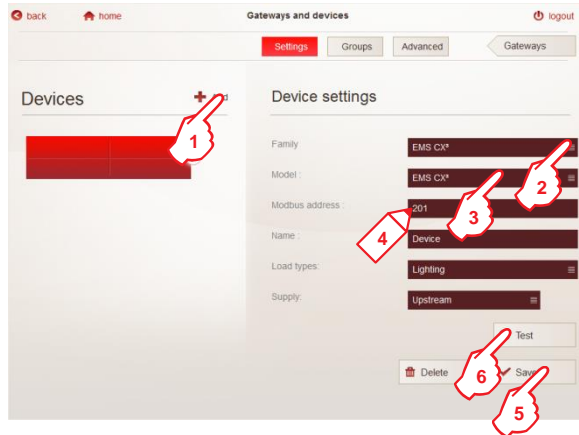

1. Click "Add"
 2. Choose the Device family from the families list
 3. Choose the model from the model list
 4. Assign the Device parameters:
 - Modbus address of the Device/Group of devices EMS CX³ (required parameter)
 - Note:** in case of an EMS system in "remote addressing mode", the Modbus address is composed as shown: "address of the device/group of devices" - "address of the EMS interface to which the devices are connected" (e.g.: device address: 2, interface address: 1 → write: 2-1)
 - Name (required parameter)
 - Load type (optional parameter)
 - Supply: current direction in the measuring sensors (required parameter for cat. Nos. 4 149 19/20/23)
 5. Click "Save"
 6. Click "Test" to verify the correct operation of the communication between the Device and the Gateway
- Repeat the operations 1. ⇒ 6. to add more devices

Note: pulse concentrator module EMS CX³ (cat. no 4 149 26) is to be managed as a standard pulse concentrator (see next page).

- Details for Measurement modules EMS CX³

Supply: to ensure correct measurement of various electrical quantities, it is necessary to indicate the current versus trough the CT(s) or Rogowski sensor(s):
 current versus upstream of tore/CT → choose Upstream (default setting)

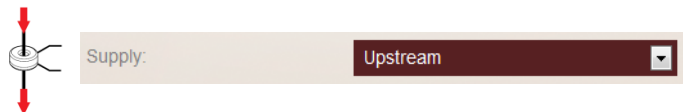

current versus downstream of tore/CT → choose Downstream



Note: to modify this setting it is necessary to delete and recreate the device.

- Procedure for Measure devices with pulse output (Electricity, Water and Gas counters)

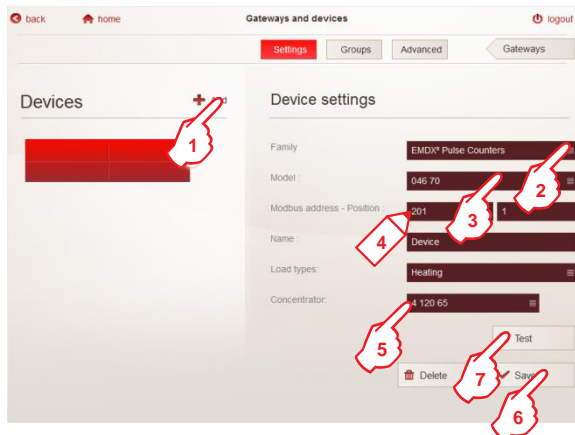

1. Click "Add"
 2. Choose the Device family from the families list
 3. Choose the model from the models list
 4. Assign the Device parameters:
 Modbus address (address of the pulse concentrator) - Position (required parameters)
 Name (required parameter)
 Load type (optional parameter)
Note: for Water and Gas Counters, load type is automatically assigned
 5. Choose the Concentrator from the list (e.g. 4 120 65)
 6. Click "Save"
 7. Click "Test" to verify the correct operation of the communication between the Device and the Gateway
- Repeat the operations 1. ⇒ 7. to add more devices

- Details for Pulse output Meters (Electricity, Water and Gas counters)

Position: is the input of the Concentrator (Cat. Nos **4 149 26***, **4 120 65** or **0 046 87**) on which the pulse output of the counter is connected.
 (* EMS CX³ device)

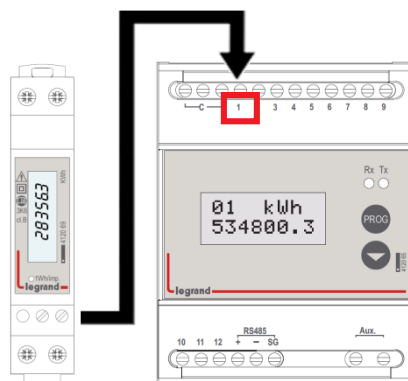

- Procedure for Circuit-breakers DPX³ - DMX³ and DX³RCD add-on modules

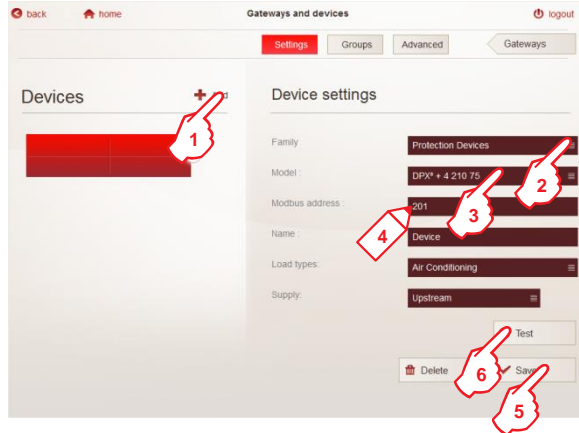

1. Click "Add"
 2. Choose the Device family from the families list
 3. Choose the model from the model list
 4. Assign the Device parameters:
 - Modbus address (required parameter)
 - Name (required parameter)
 - Load type (optional parameter)
 - Supply direction of the Circuit-breaker (required parameter)
 5. Click "Save"
 6. Click "Test" to verify the correct operation of the communication between the Device and the Gateway
- Repeat the operations 1. ⇒ 6. to add more devices

- Details for Circuit-breakers DPX³ - DMX³ and DX³RCD add-on modules
Supply: to ensure correct measurement of various electrical quantities, it is necessary to indicate the Supply direction of the circuit-breakers:

circuit-breaker supply from the top → choose Upstream (default setting)

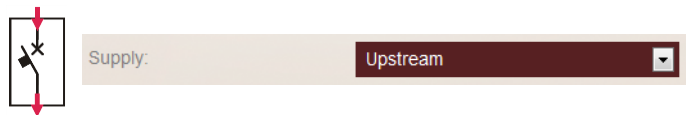

circuit-breaker supply from the bottom → choose Downstream



Note: to modify this setting it is necessary to delete and recreate the device.

- Procedure for Green'Up Charging Stations (Old range) - "One-side" Stations

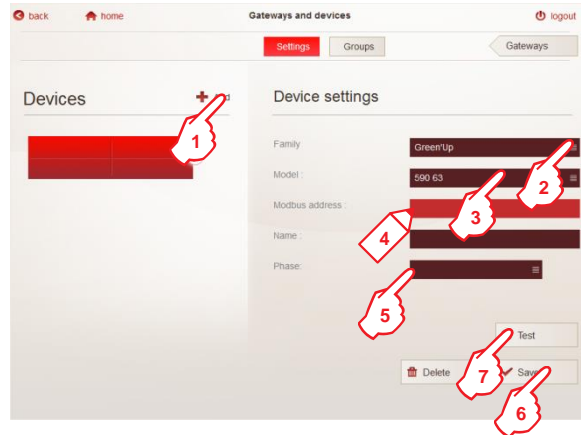

1. Click "Add"
 2. Choose the Device family from the families list
 3. Choose the model from the models list
 4. Assign the Device parameters:
 - Modbus address (required parameter)
 - Name (required parameter)
 5. Assign the Phase at which the Station is connected (required parameter - only for single-phase stations)
 6. Click "Save"
 7. Click "Test" to verify the correct operation of the communication between the Device and the Gateway
- Repeat the operations 1. ⇒ 7. to add more Stations.

- Procedure for Green'Up Charging Stations (Old range) - "Two-sides" Stations

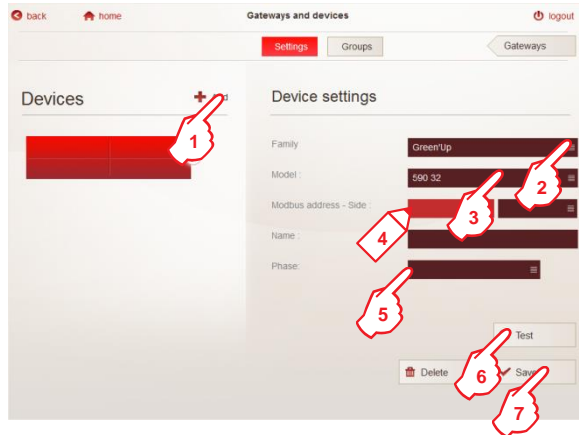

1. Click "Add"
 2. Choose the Device family from the families list
 3. Choose the model from the models list
 4. Assign the Device parameters:
 - Modbus address (required parameter)
 - Side (required parameter - only for the stations with 2 sides)
 - Name (required parameter)
 5. Assign the Phase at which the Station is connected (required parameter - only for single-phase stations)
 6. Click "Test" to verify the correct operation of the communication between the Device and the Gateway
 7. Click "Save"
- A pop-up window appears

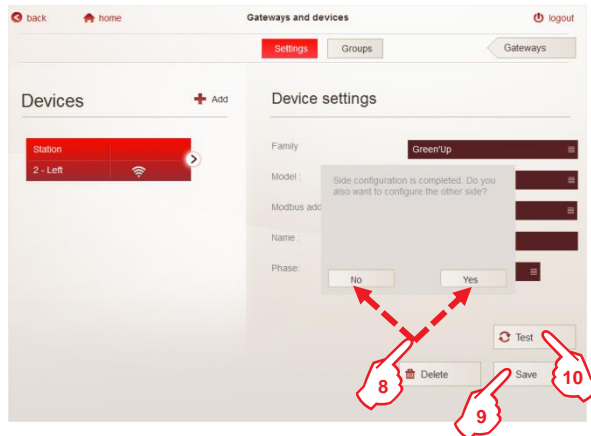

8. Click "Yes" if you want to set the parameters for the other side of the "Two-sides" station; in this case, for the new side, is necessary to assign only:
 - Name
 - Phase
 9. Click "Save"
 10. Click "Test" to verify the correct operation of the communication between the Device and the Gateway
- Repeat the operations 1. → 10. to add more "two-sides" stations

- Procedure for Green'Up "Premium" Charging Stations (New range)

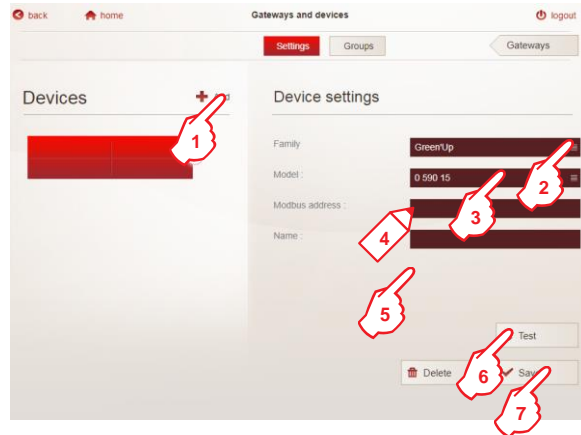

1. Click "Add"
 2. Choose the Device family from the families list
 3. Choose the model from the models list
 4. Assign the Device parameters:
 - Modbus address (required parameter)
 - Side (required parameter - only for the stations with 2 sides)
 - Name (required parameter)
 5. Assign the Phase at which the Station is connected (required parameter - only for single-phase stations)
 6. Click "Save"
 7. Click "Test" to verify the correct operation of the communication between the Device and the Gateway
- Repeat the operations 1. ⇨ 7. to add more "two-sides" stations

Note: "two-sides" charging stations of the new range (Cat.nos 0 590 11/13/15/42/44/49) have to be considered as two different Modbus RS485 devices. **Each side of the Charging station has its own Modbus address.** For programming, repeat twice the procedure from 1. to 7. choosing the same catalogue number (e.g. 0 590 44)

- Procedure for "Generic" Measurement/Counting Devices with Modbus RS485 output

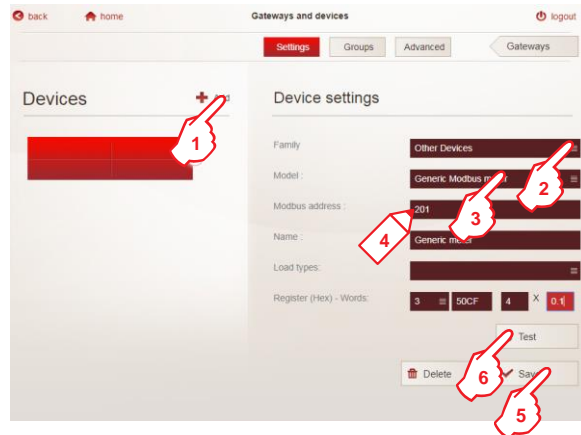

1. Click "Add"
 2. Choose the Family "Other devices" from the families list
 3. Choose the model "Generic Modbus meter" from the models list
 4. Assign the Device parameters:
 - Modbus address of the Measurement / Counting device (required parameter).
 - Name (required parameter)
 - Load type (optional parameter)
 - Register (hex) - Word: in these 4 fields you must enter the following parameters:
 - Modbus register read code (3 or 4)
 - Modbus register of positive active energy (value in hexadecimal)
 - number of words to read
 - multiplying factor to use to obtain the correct value

Note: these four information can be found in the documentation of the meter / counter, provided by the device manufacturer.
 5. Click "Save"
 6. Click "Test" to verify the correct operation of the communication between the Device and the Gateway
- Repeat the operations 1. ⇒ 6. to add more "Generic" measurement/counting devices

7.15.1.4 Advanced options

In the “Devices” page

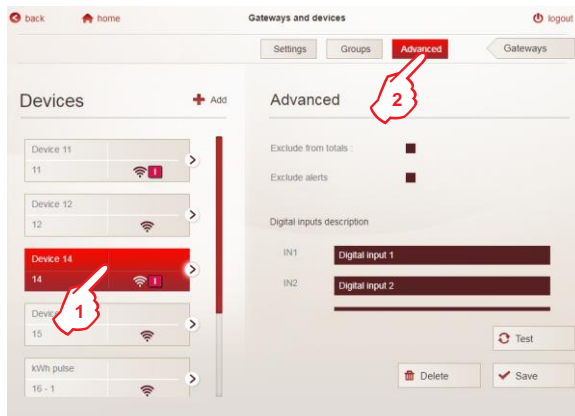

1. Select a Device
2. Click “Advanced”

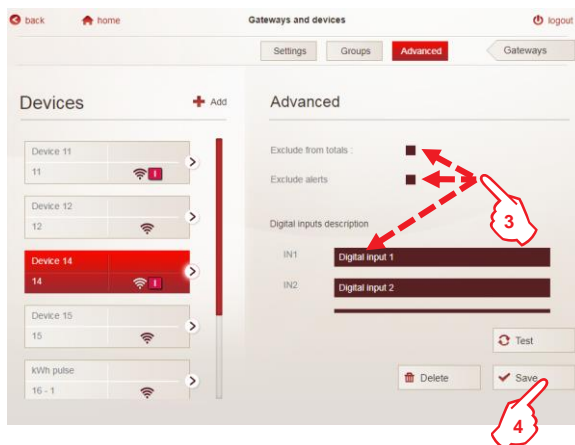

3. In this page for each device configured by the user, it is possible to set following options:

- “Exclude from totals”. Select this option if you don’t want that the quantities measured by this device are added on the histograms in the “Grand Total” and “Partials” page of the menu “Consumptions”.

Histograms of consumptions will be displayed only in the “Details” page of the menu “Consumptions”. (see details on page 48)

- “Exclude alerts”. Option available for EMS CX³, DPX³ and DMX³ devices.

Allows you to disable/exclude reports of alert(s) on events related to these types of devices.

Note: configuration of the type of events that cause a report, is available in the “Alert settings” page of the “Email and notification” menu of the Web server (see § 8.6.4)

- Customize the description of inputs and outputs for supervision devices 0 261 36 and 0 288 12 and for Universal State (4 149 30) and Universal Control (4 149 32) Modules, of the EMS CX³ range, in generic configuration.

4. Click “Save” to confirm settings

• **Procedure to activate the “EQ device” function**

EQ device is an optional function used to perform the energy quality check according to standard EN 50160.

To do this is necessary set a device as “EQ device” in Gateways and devices page.

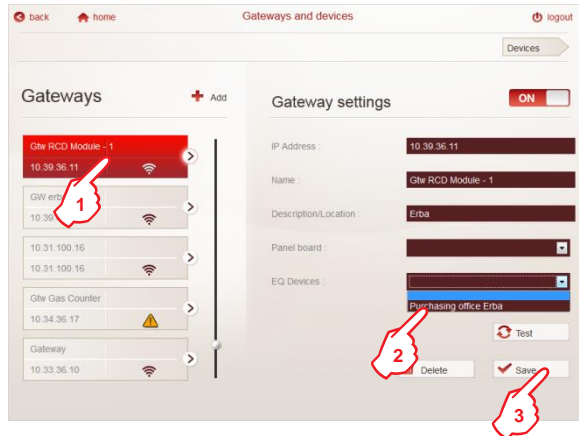

1. Select a Gateway
2. In correspondence of EQ device choose from the list box the device to set as energy quality device (in the list box are displayed only devices with THD or THD + Harmonics functions added to the selected gateway).
3. Click “Save”

Note: for each gateway is possible to set only one device as “EQ device”.

Software perform automatically the weekly check and shows the result in the Consumption Details page with the label “LAST WEEK EN50160 CHECK: OK or KO”

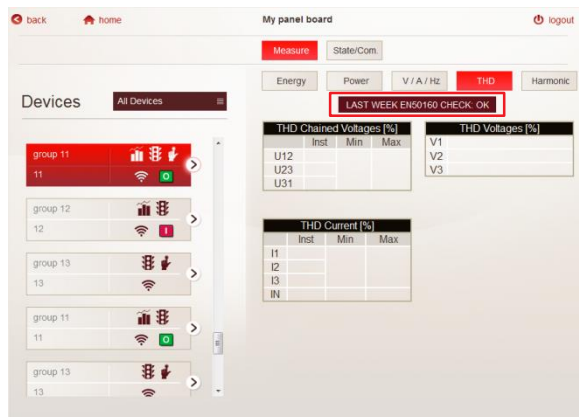

At the same time the software creates the folder “eqcheck” in the web server’s data base saved on the HDD of the Web Server (see 8.4.3).

Note: this function is only available for cat.no 4 149 48

• **Details for the option “Exclude from totals”**

This option must be enabled if the measurement of a device is cumulative with the measurement carried out by a general measuring device.

In the example: consumptions of the line "Lighting" would be counted twice in the histograms of global consumption.

The device 2 will be excluded from the totals to ensure the accuracy of the measurements, but its data will be displayed on the page "Details" of the menu "Consumption".

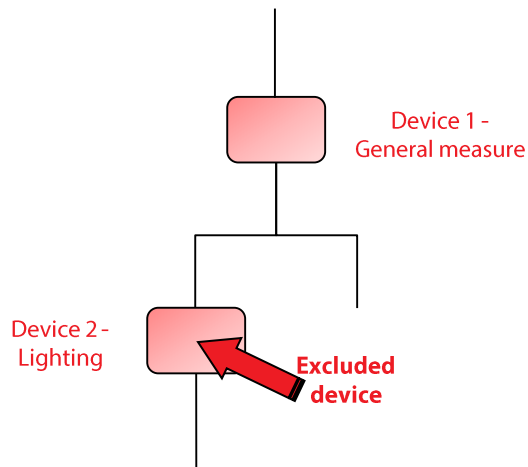

• **Description of the device selection button**



1. Modbus Address (Modbus Address - Position for the counters with pulse output or Modbus Address - Side for the "two-sides" charging stations)
2. Name of the device
3. This symbol appears only if the device is a protection device and shows the circuit-breaker state:
 - Open
 - Closed
 - Tripped
4. Device status
 - On
 - Off
 - Communication error

7.15.1.5 System functions

– ON/OFF Button



Allows to enable/disable a Gateway or a Device; the function is available only for Gateways and Devices.

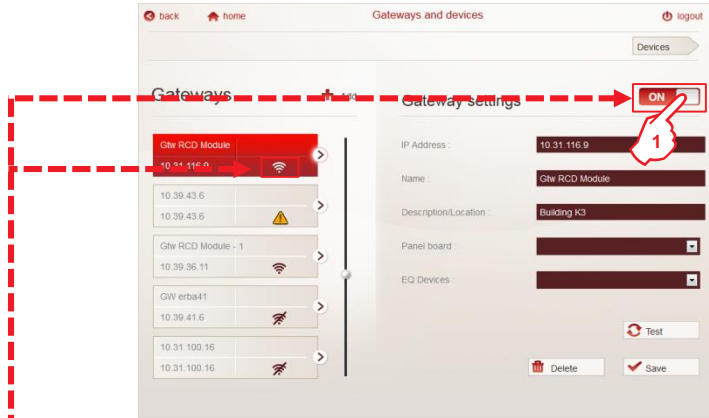

1. Click "ON" to switch off a Gateway / Device

The selected Gateway / Device and the button switch into the OFF state.

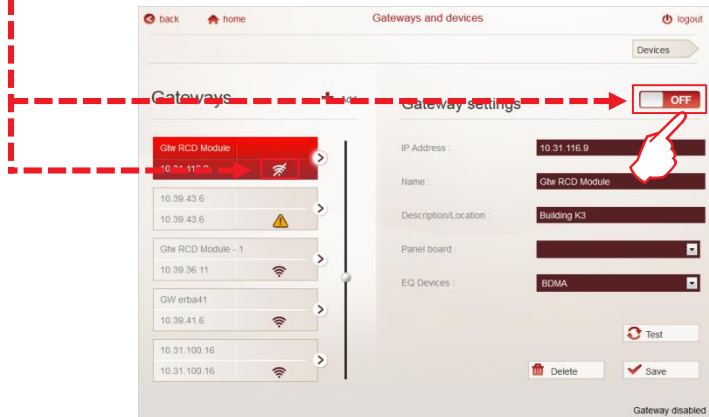

Note:

- The deactivation of a Gateway causes the deactivation of all devices connected to it.
- If a device is turned-off, its measurement data will not be displayed in the "Devices" page.
- To return a Gateway / Device in the ON state, simply click "OFF"

– DELETE Button

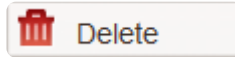

Allows to erase a Gateway or a Device.

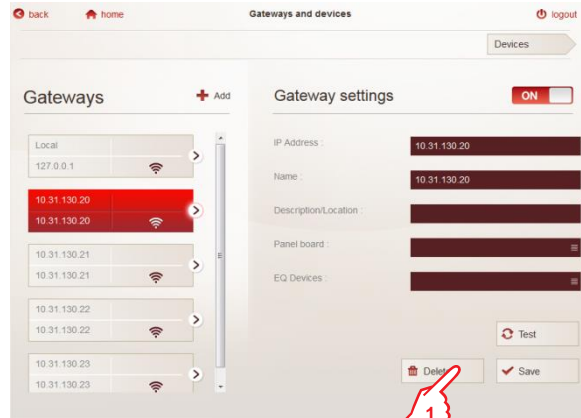

1. Click “Delete” in the “Gateway settings” or “Device settings” page
A confirmation page appears.

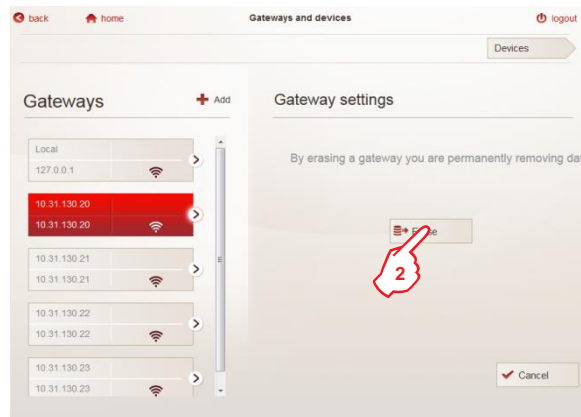

2. Click “Erase” to confirm the deletion of the Gateway or the Device

Note1: To erase a Gateway, is necessary delete all the devices connected to it at first!

Note2: “Local” Gateway can not be erased but only put in “OFF” state!

• **LIST OF REQUIRED PARAMETERS:**

- Highly required parameters - Address/Position:
 - ✓ Modbus Address, a different Modbus address for each device connected to the same bus RS485
 - ✓ Positions, different for wiring reasons; (only for Counters with pulse output)
- Essential parameter – Name:
 - ✓ Impossible to use several times the same name
 - ✓ If forgotten during the settings, Web Server will assign a default value (IP Address for Gateway, Modbus Address for Devices RS485, Modbus Address-Position for Devices with pulse output, Modbus Address-Side for the Charging stations “two sides”).
- Useful parameter – Model:
 - ✓ Possibility to have one, two or several identical models.
 - ✓ If forgotten during the settings is shown the message “Configuration Error”.

7.15.2 Loads, Groups and Panel boards configuration

Optional setup, used to give a description of the electrical installation by panel board(s), load(s) and group(s)

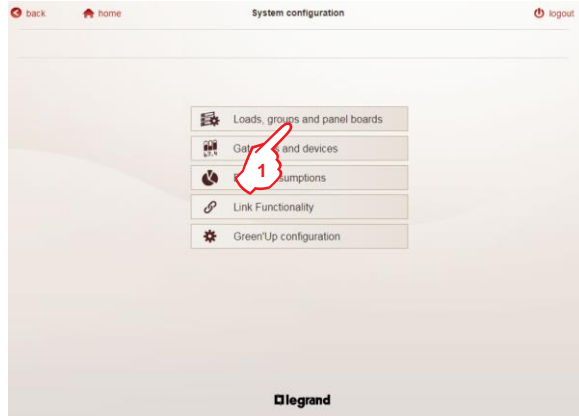

1. Click "Loads, groups and panel boards"

Loads, groups and panel boards settings page appears.

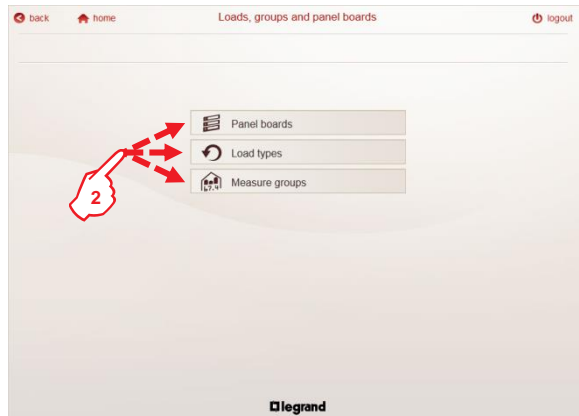

2. Click "Panel boards", "Loads" or "Measure Groups" to create a panel board, a load or a measure group.

Every page is divided into two sections:

- left section is the "Added Panel boards / Loads / Measure groups" area.
- right section shows the "Panel boards / Loads / Measure groups" settings area, where the configuration fields are available.

7.15.2.1 Panel boards

• CREATING AND SAVING PANEL BOARD

For a physical distribution of the different panel boards of the installation.

Recommended architecture: only one Gateway per Panel board

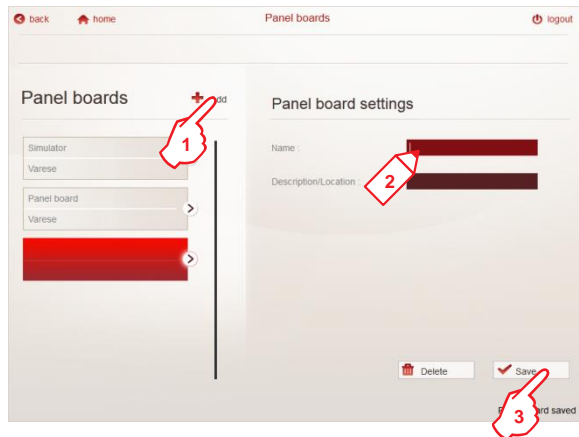

To create a Panel board:

1. Click "Add"
2. Assign the panel board parameters:
Name (required parameter)
Description/Location (optional parameter)
3. Click "Save"

Repeat the operations 1. ⇒ 3. to add more panel boards

• ASSIGNMENT OF PANEL BOARDS

Return to the section "Gateways and Devices" in "System configuration".

In the Gateway settings area of the Gateways page, is possible to assign each gateway previously created, to a Panel board.

Note: a gateway can be assigned to only one panel board.

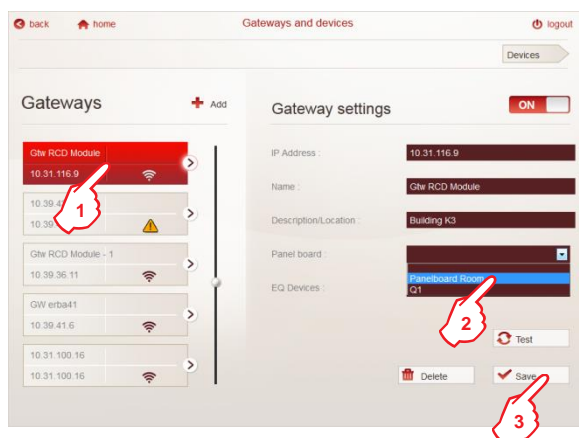

1. Choose a Gateway
2. Choose a Panel board from the Panel boards list
3. Click "Save"

7.15.2.2 Loads

• CREATING AND SAVING LOADS

are available:

- 6 "pre-defined" categories (heating, air conditioning, etc.) according by the Thermal Regulations 2012 (RT 2012)
- Category "Others" to display the measurement without Load assigned
- 8 additional categories, user-creatable

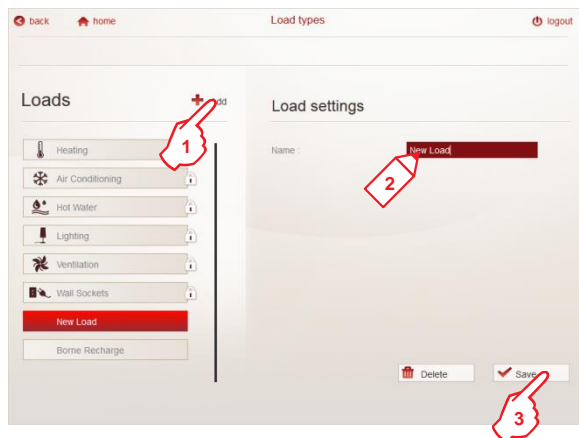

To create a Load:

1. Click "Add"
2. Assign the load parameter:
Name (required parameter)
3. Click "Save"

Repeat the operations 1. ⇒ 3. to add more loads

Note: it is possible to have a maximum of 14 loads.

• ASSIGNMENT OF LOADS

Return to the section "Gateways and Devices" in "System configuration".

In the Device settings area of the Devices page, is possible to assign a Load to each virtual or physical Device previously created.

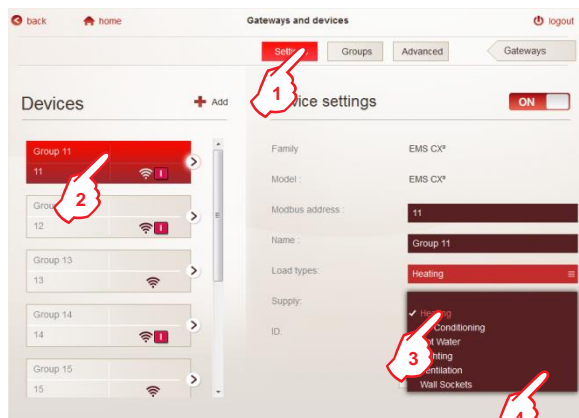

1. Click "Settings"
2. Choose a Device
3. Choose a Load from the Loads list
4. Click "Save"

7.15.2.3 Measure groups

• CREATING AND SAVING MEASURE GROUPS

For a logical distribution of the measuring points of the installation

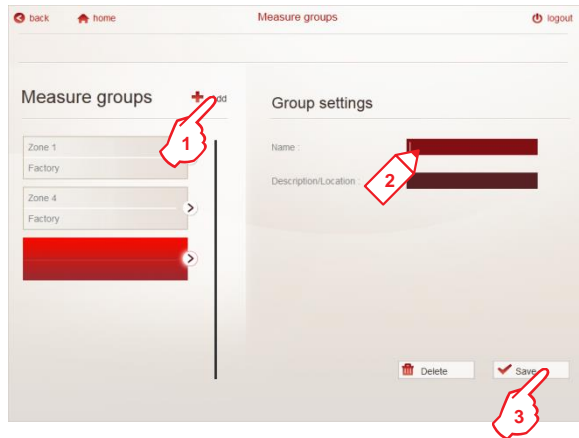

To create a Measure group:

1. Click "Add"
2. Assign the measure groups parameters:
Name (required parameter)
Description/Location (optional parameter)
3. Click "Save"

Repeat the operations 1. ⇒ 3. to add more groups

• ASSIGNMENT OF MEASURE GROUPS

Return to the section "Gateways and Devices" in "System configuration".

In the Device settings area of the Devices page, is possible to assign a Measure group to each virtual or physical Device previously created.

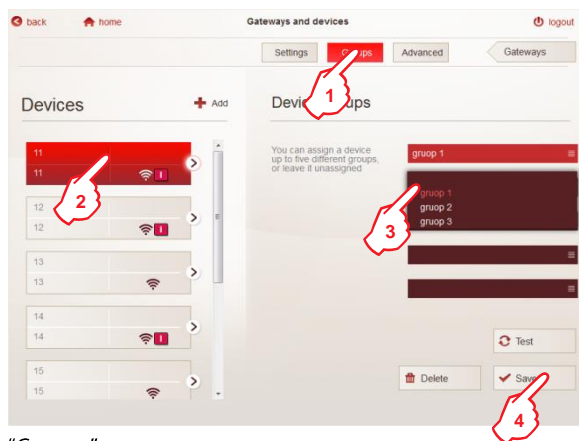

1. Click "Groups"
2. Choose a Device
3. Choose a Measure group from the Measure groups list
4. Click "Save"

Repeat the operations 2. ⇒ 4. to assign a device to another group

Note: a device can be associated with several groups simultaneously (up to 5).

7.15.2.4 System functions

– DELETE Button

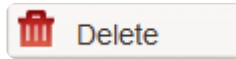

Allows to disable / erase a Panel board, a Load or a Measure group.

Note: For the “pre-defined” loads the disabling is the only function permitted.

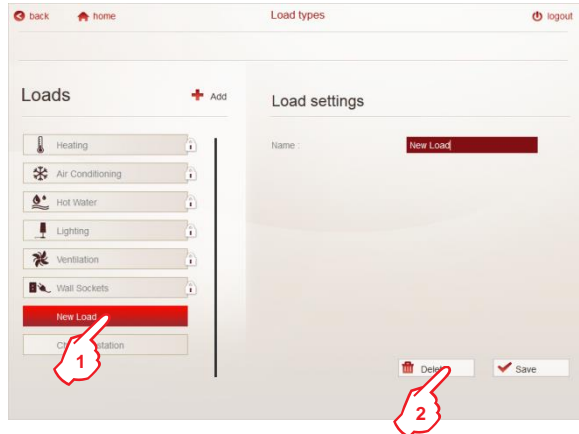

In the Panel boards / Loads / Measure groups settings area:

1. Choose a Panel board / Load / Measure group
2. Click “Delete

An intermediate page in which, the deactivation (Disable) or the erasing (Erase) of the selected Panel board / Load / Measure group is proposed.

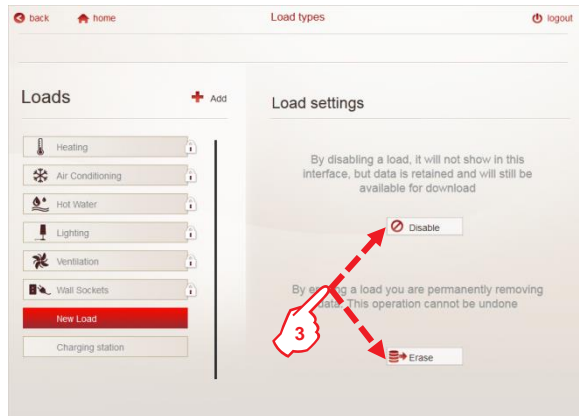

3. Click “Disable” to deactivate the Panel board / Load / Measure group or “Erase” to remove definitively the Panel board / Load (possible only for the “user-creatable” loads) / Measure group.

By clicking on “Disable” the selected Panel board / Load / Measure group, goes into “Deactivated” state.

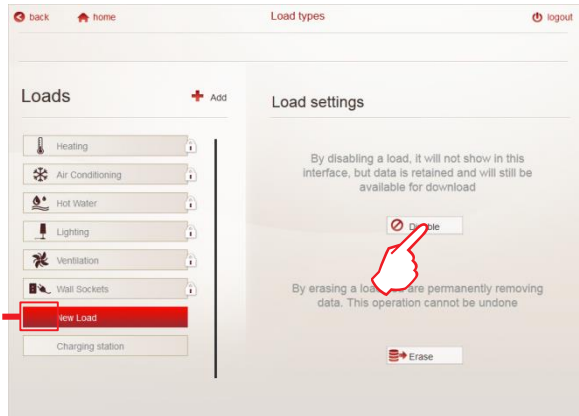

This state is indicated by the symbol  near the Panel board / Load / Measure group's name.

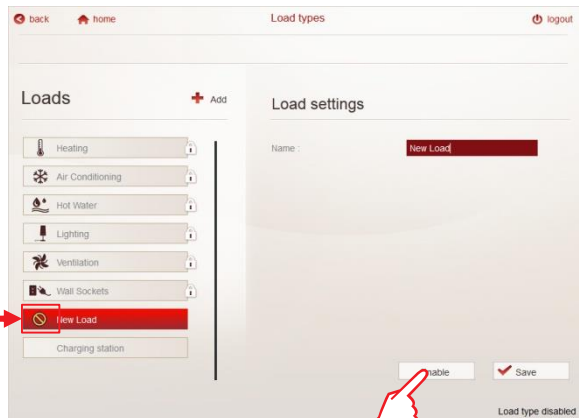

To enable a Panel board / Load / Measure group, simply click “Enable”.

7.15.3 Bill of Consumptions configuration

Optional setting, allows the economic accounting of Electricity, Water and Gas consumptions

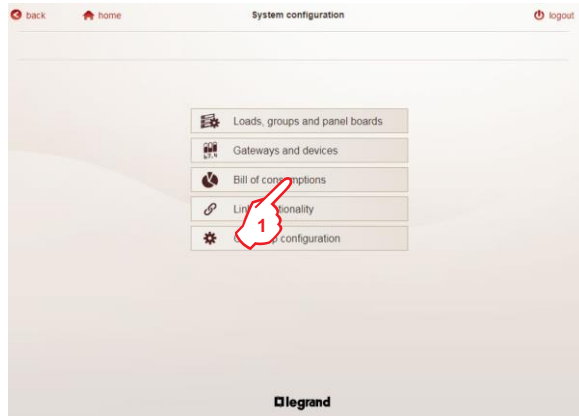

1. Click "Bill of consumptions"

Bill of Consumptions setting page appears



2. Assign the Currency using the three-letter alphabetical code according to ISO 4217 standard (e.g. EUR, USD, GBP, ...)

3. Assign the average price for the Electricity (price of kWh), Gas (price of m³) and Water (price of m³)

4. Assign the conversion factor (m³/kWh) to display Gas consumptions also in "Equivalent kWh"

Note: Conversion factor should be provided by your Gas supplier; contact it to get the conversion rate

5. Click "Save"

IMPORTANT: the value of the cost of consumption is calculated with an average price and therefore remains an approximation. This value is usable for statistical purposes only.

7.15.4 Configuration of the data sample rate

Optional setting, allows to edit the recording time of Electricity data including statistical data (if available in the devices), of Water and of Gas in the Web Server database..

Note: default value: 10 minutes

Parameter "Sample rate" affects :

- histograms updating in the consumptions display pages
- Recording of consumptions data in the database
- recording of the statistical values (average values, minimum, maximum, ...) for measuring devices which have these values
- "CSV" files saved in the FTP space of the web server
- "CSV" files downloaded with the "Data download" function

Procedure to edit the setting:

In the Web Server's home page

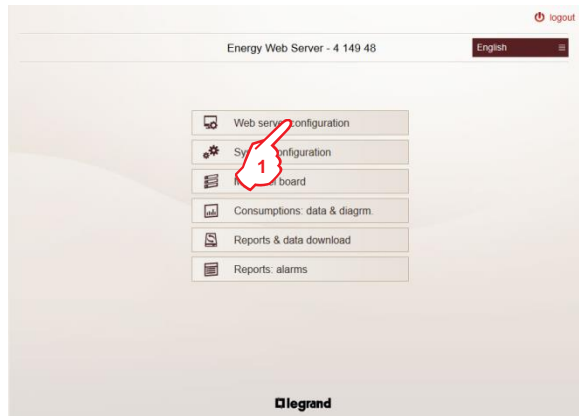

1. Click "Web Server configuration"

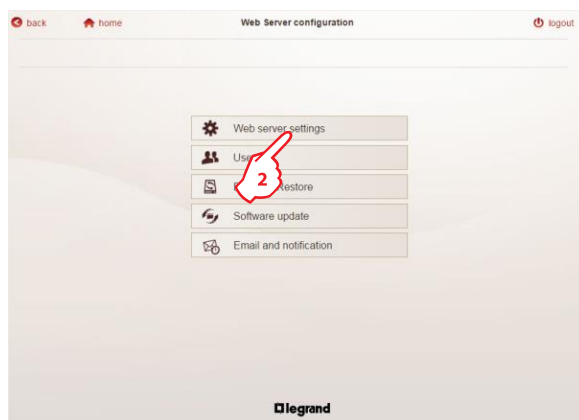

2. Click "Web server settings"

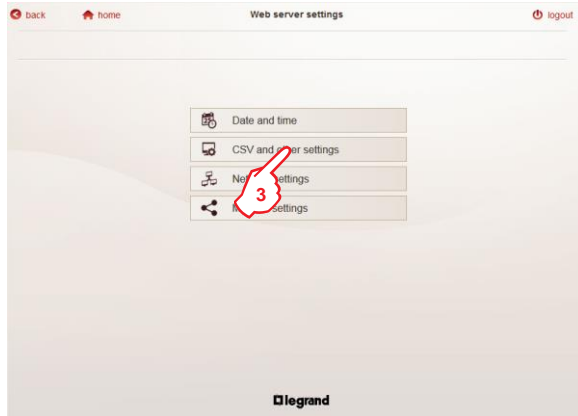

3. Click "CSV and other settings"



4. Select the "Sample rate" value.

5. Click "Save".

Note: Editing of this setting does not affect data already saved by the Web Server before changing the value.

7.15.5 Green'Up configuration

Optional setting, allows to enable the control logics for the automatic management of the charging processes.

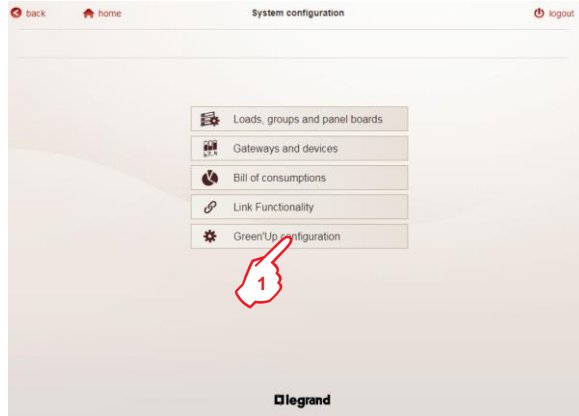

1. Click "Green'Up configuration"

Green'Up's configuration page appears.



2. Click "Management configuration" or "Priority Stations" to set the parameters for the control logics.

7.15.5.1 Management configuration

Before enabling the control logics, it's necessary to assign the benchmarks on which the logics are based.

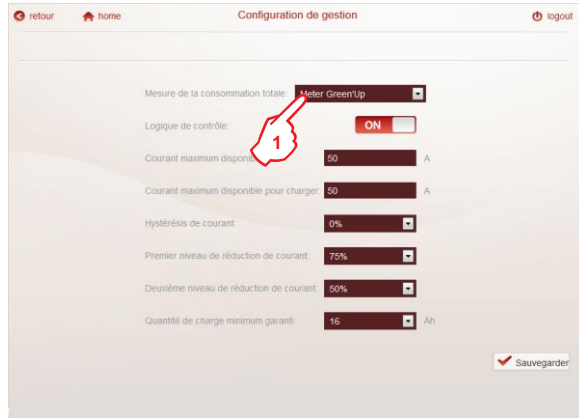

1. Click to choose from the list of devices added during the configuration procedure, which is the Total power consumption meter. (see images below)

(Image 1)
the meter measures the power consumption of the entire system

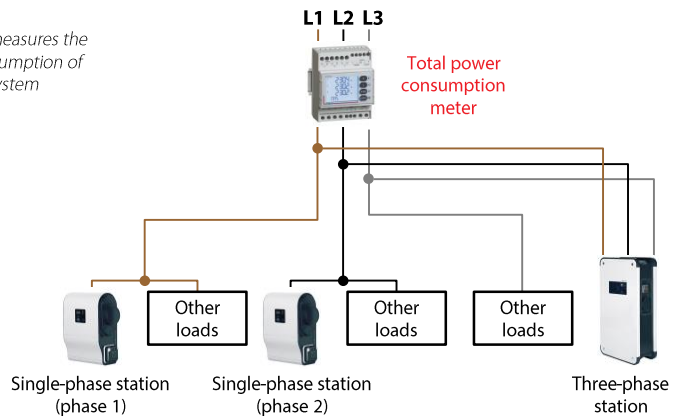

This configuration allow to install Charging Stations in an existing installation and promotes charging processes because the limit of maximum current available for the charging is dynamically repositioned according the consumption of other loads.

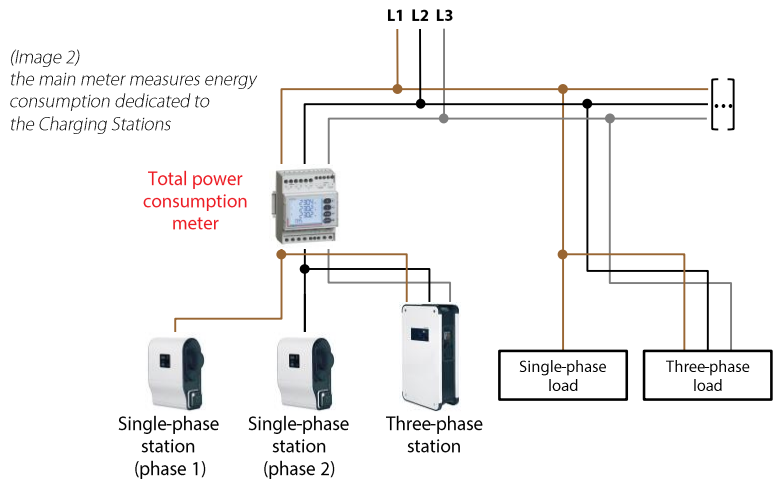

This configuration does not take into account consumption and availability of potential energy from the other loads of the installation because the limit of maximum current available for the charging is fixed and imposed by the rated current of the part of the installation dedicated to charging stations.

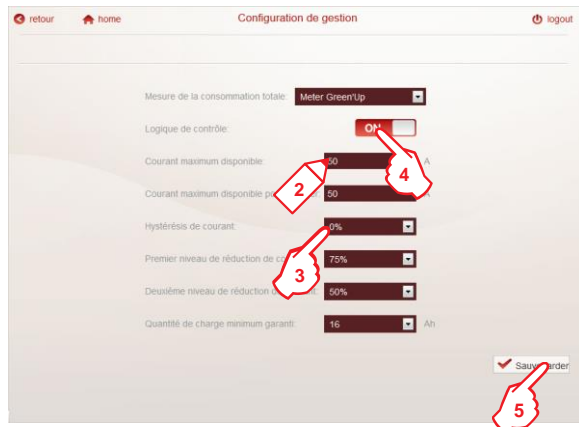

2. Enter the current values:

- Maximum current available: is the rated current of the installation (image 1) or of the installation portion dedicated to charging stations (image 2) which defines the threshold between yellow and red areas.
- Maximum current available for the charging: is the current value dedicated to charging processes, which defines the threshold between green and yellow zones.

Note:

- If the installation is composed of only charging stations (no other loads), or a portion of the installation is dedicated to vehicles recharging (image 2), these two parameters can be equals.

(see details on next pages)

3. Assign the other control logics parameters:

- Current consumption hysteresis
- First reduction step for the charging current
- Second reduction step for the charging current
- Minimum guaranteed charging quantity

(see details on next pages)

4. Click to switch the selector on "ON" position to enable the automatic control logics

5. Click "Save" to confirm configurations

• **Details for Management configuration's options**

Set the options:

Maximum current available (ex. 250 A)

Maximum current available for charging (ex. 230 A)

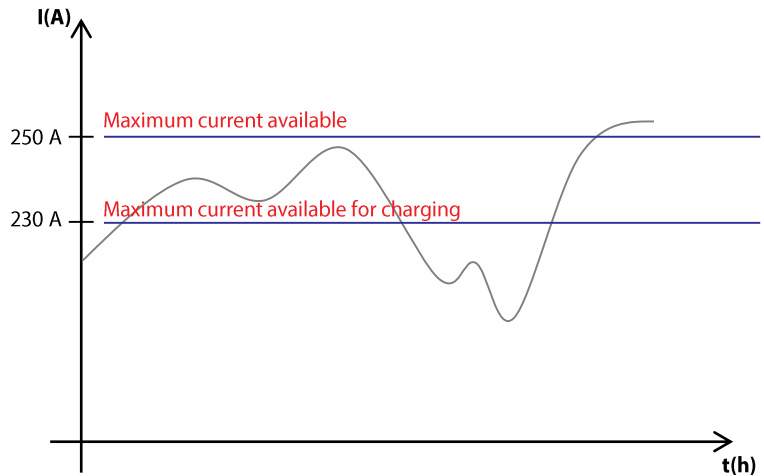

These two options are used to define three work areas:

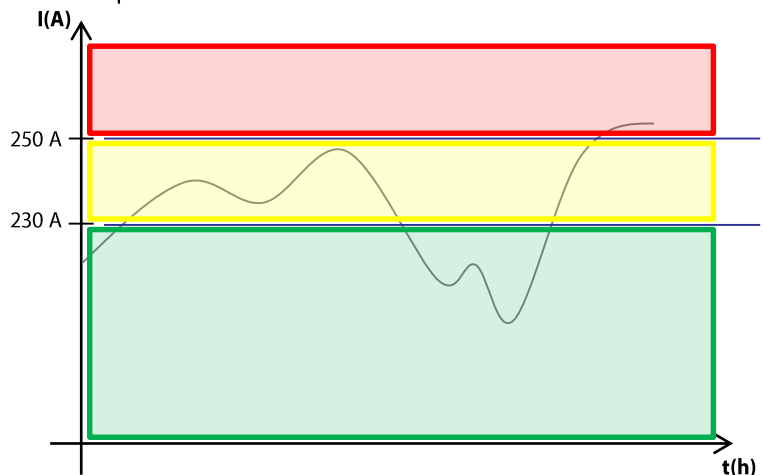

Green area: all charging processes in progress continue, each new charge request is authorized.

Yellow area: all charging processes in progress continue. No new charge request is authorized until the system returns in the *green area*. If there is a charge request in waiting status, control logics try to return the system in the *green area* by reducing the charging current of the processes already in progress (according to the reduction steps configured). This operation allow the waiting charging request to start.

Red area: no new charge request is authorized. Control logics try to return the system in the *yellow area* reducing the charging current of the processes in progress (according to the reduction steps configured).

If all charging currents have been reduced at the second reduction step, and the system remains in the *red area*, control logics begin to stop the processes in progress starting from the non-priority station connected for the longest time, which has already received the minimum guaranteed charging quantity.

Note: Moving from an high alert area to an area with lower alert level, when the level of available power is sufficient, there are two possibilities:

- If many charging processes are in waiting mode, control logic will promote the recovery of the charging processes starting from the process in waiting mode for the longest time and so on.
- otherwise, control logic will allow increasing the current level of the charging processes already in progress, always promoting the first process previously reduced and so on.

Current consumption hysteresis: value expressed in % of maximum current available; is used to define an area in which are ignored variations of the current value, to avoid repeated activations and deactivations of the logics.

In the example below the hysteresis value is used to ignore the behaviour of the wave form (Default value 0%).

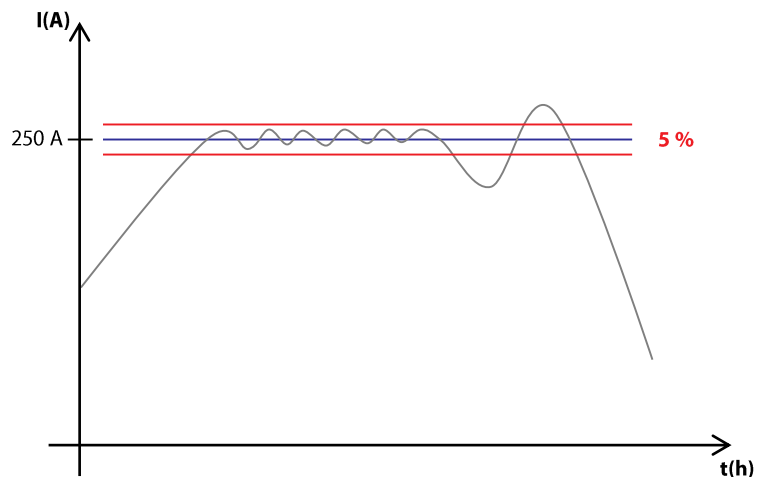

First and Second reduction step for the charging current: parameters used to define the reduction of the charging current when the system is in the yellow or red area. (Default values 75% and 50%).

Note: charging current for each reduction step, is calculated on the base of the rated current of the station.

Minimum guaranteed charging quantity: parameter used to ensure a minimum charging level to every vehicle in charge (Default value 32Ah).

When a vehicle is connected to a station for a new charging process, it will not be stopped until the vehicle has received the quantity of charge configured.

Note: in function of the type of battery and the way of charge (single or three phase process), the minimum guaranteed current ensure a different level of charge of the battery.

Example :

- 32Ah for a vehicle connected to a three-phase station (rated current 32 A), corresponds to an energy transferred to the battery of 22 kWh. The minimum charging quantity is reached in 1 hour.
- 32Ah for a vehicle connected to a single-phase station (rated current 16 A), corresponds to an energy transferred to the battery of 3,6 kWh. The minimum charging quantity is reached in 2 hours.

7.15.5.2 Priority stations

This page allows to set the priority of the Charging Stations in the waiting charging list.

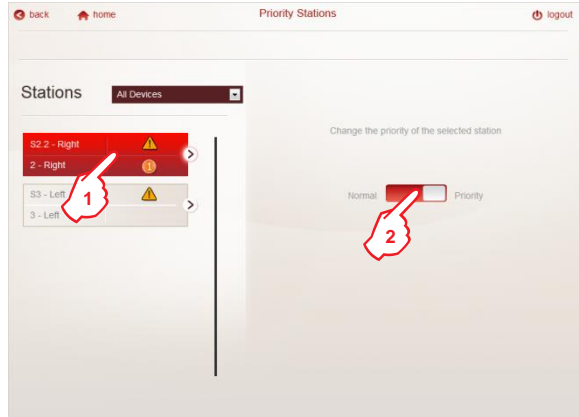



1. Click to select a charging station or a side of a charging station. It is possible to filter the research per Gateway or "All Devices"
2. Click to switch the selector from "Normal" to "Priority" position to increase or decrease the priority of a charging station.

If a station is set "priority" the symbol  appears in the device selection button on the left part of the page.

Note: the selected charging station/side of charging station is now priority per default.

• Description of the charging station selection button



1. Modbus Address (Modbus Address - Side for the "two-sides" Charging Stations)
2. Name of the device
3. Error's icons
 -  Communication error
 -  Charging station failure
4. Priority of the charging Station / Side of the charging station
 - no symbol: Normal
 -  Priority charging station

7.15.6 Master/Slave function

This function allows you to use a web server as “Master” of one or more “Slave” web servers in order to let the “Master” acquire consumption data recorded by the “Slaves”.

The function allows you to manage, for example:

- installations with multiple levels
- systems with more than 255 measuring points

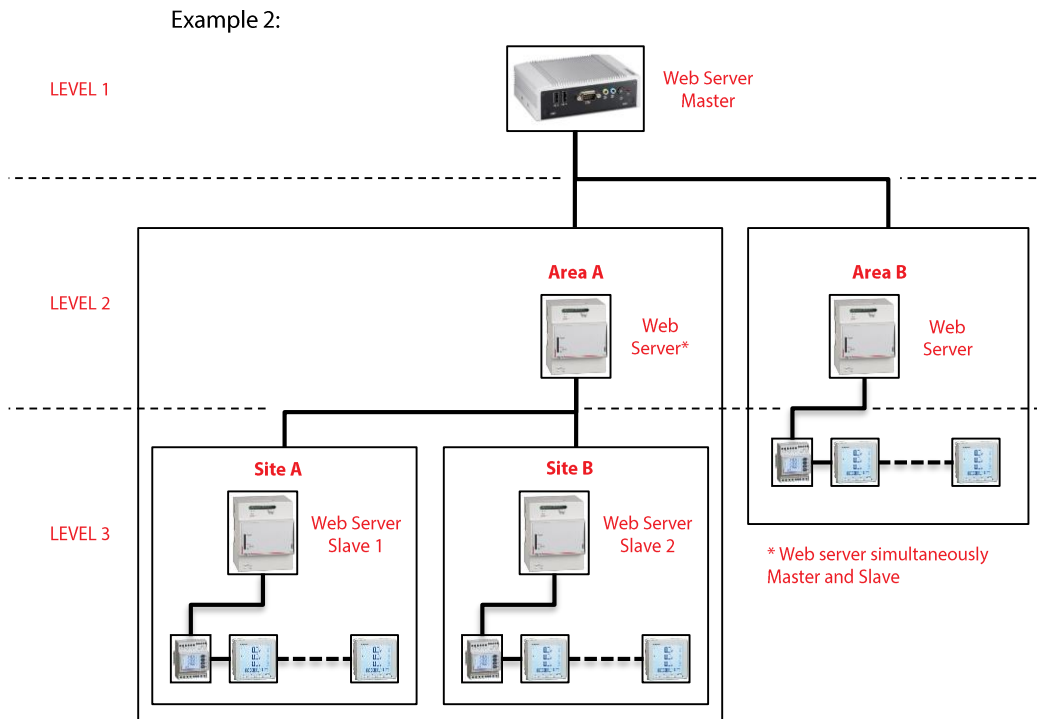
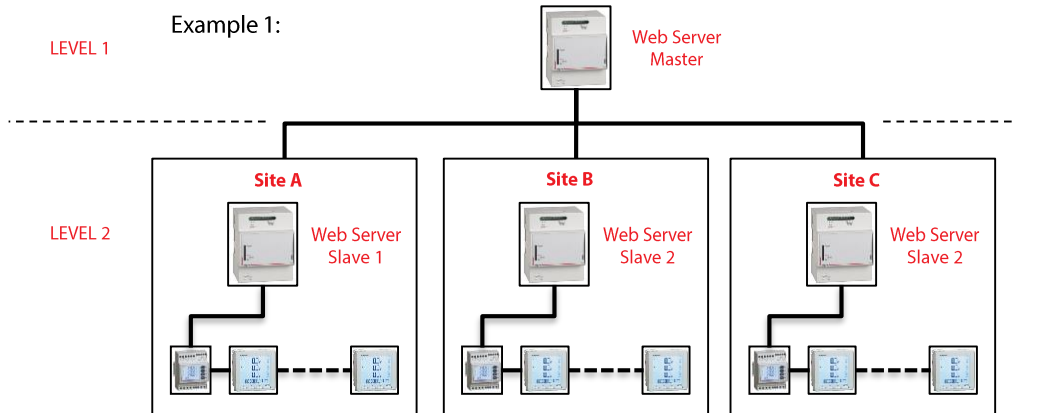

The data that can be acquired from the “Master” web server are the following:

- Positive active Energy of a specific Device
- Positive active energy of a specific Load
- Positive active energy of a specific Measure group
- Total Positive active energy of all Electrical Loads

7.15.6.1 Activation of the Function

This configuration is to be performed only on Slave Web Server(s) and is used to give the Master permission to access the data registered by the Slave(s).

Procedure to activate the function on the Slave Web Server(s):
In the Web Server's Home page

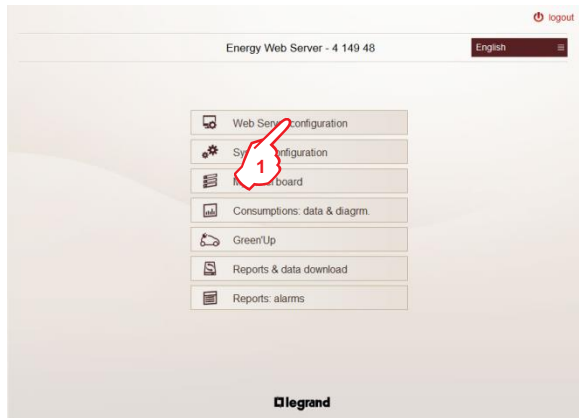

1. Click "Web Server configuration"

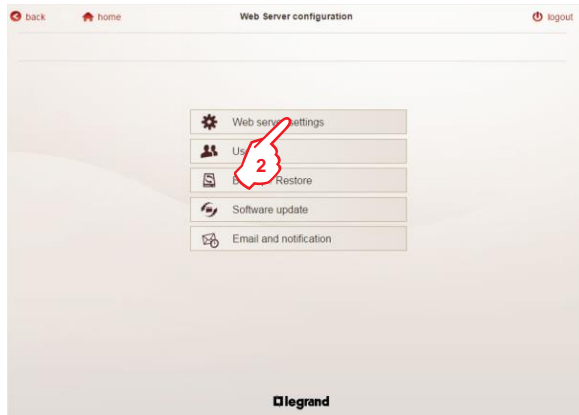

2. Click "Web server settings"

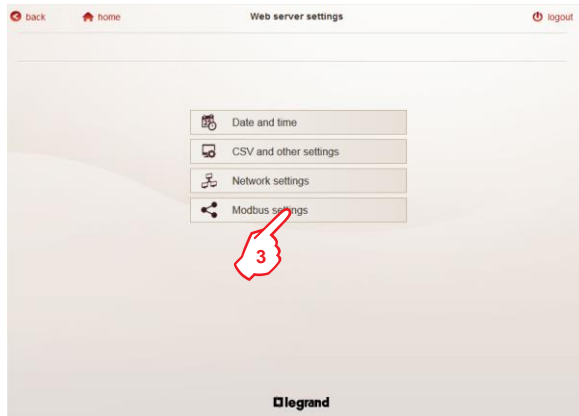

3. Click "Modbus settings"

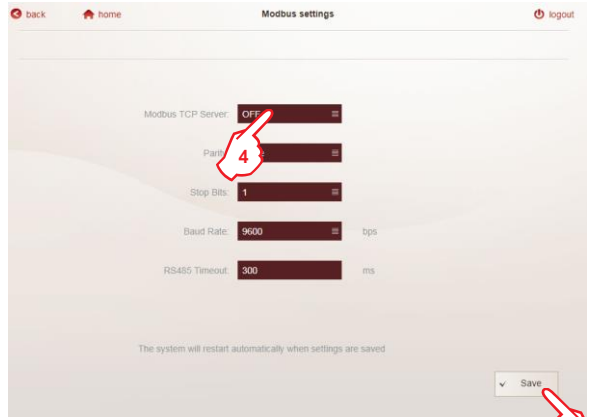

4. Click to to Enable (“ON”) the Modbus TCP Server used for Master/Slave function

5. Click “Save” **2 times** to confirm

Note: System will restart automatically when settings are saved

7.15.6.2 Creating and Saving of “Virtual” Gateways and Devices

Procedure for creating and saving “Virtual” Gateways and Devices is the same used for physical Gateways and Devices.

In the Web Server’s Home page

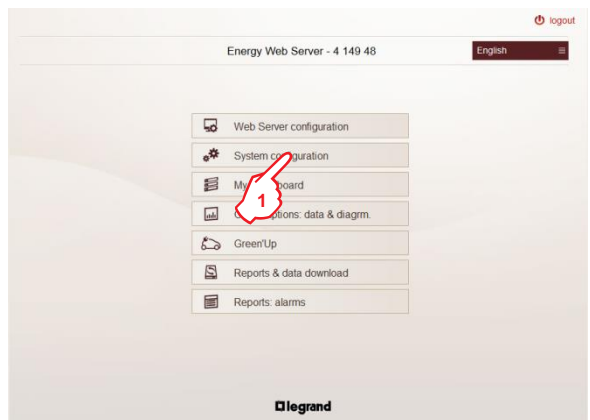

1. Click “System configuration”

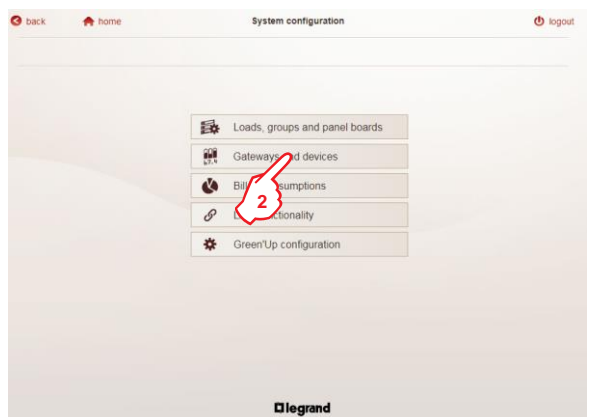

2. Click “Gateways and devices”

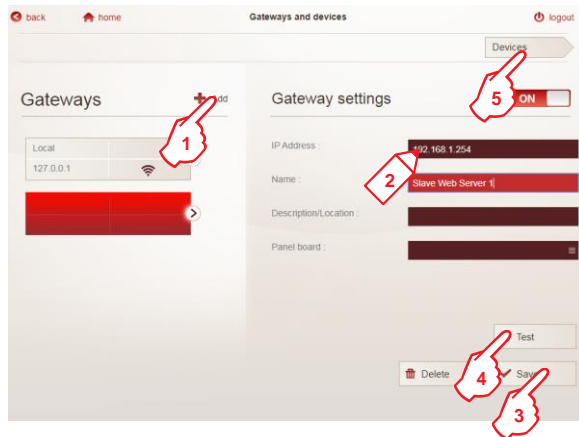

1. Click "Add"
2. Assign the parameters to the Virtual gateway = Slave Web server:
 IP Address of the Slave Web Server (required parameter)
 Name (required parameter)
 Description/Location (optional parameter)
3. Click "Save"
4. Click "Test" to verify the correct operation of the communication between the Web Server and the Gateway
5. Click "Devices" to configure the devices connected to the Slave Web server
 Device's settings page appears

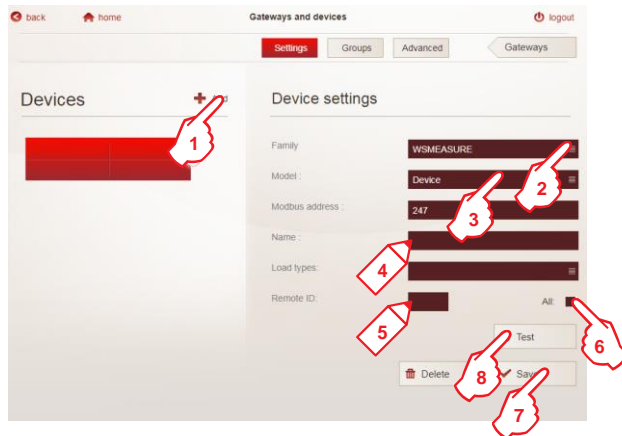

1. Click "Add"
2. Choose the family "WSMEASURE" from the families list
3. Choose the Model from the models list
4. Assign the Device parameters:
 Name (required parameter)
 Load type (optional parameter)
Note: Modbus Address is automatically filled
5. Enter the specific "Remote ID" of a Device, Load or Measure Group configured in the Slave Web server or 6. Click on "All" to return Total Active Energy of all Electrical Loads of the slave web server (the "Remote ID" field will be filled automatically)
7. Click "Save"
8. Click "Test" to verify the correct operation of the communication between the Device and the Gateway

- **Details for the “Remote ID” parameter**

The “Remote ID” is the ID number of a Device, Load or Measure Group in the slave web server database.

This unique number is assigned to a Device, Load or Measure Group during the system configuration and it is shown:

- in the “Gateway and devices” page for Devices (see image below)

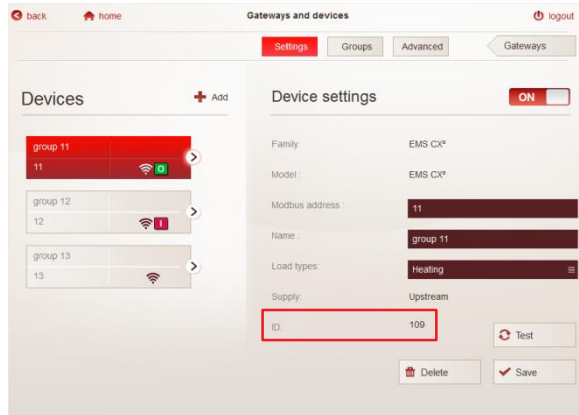

- in the “Load types” page for preconfigured or user-created Loads (see image below)

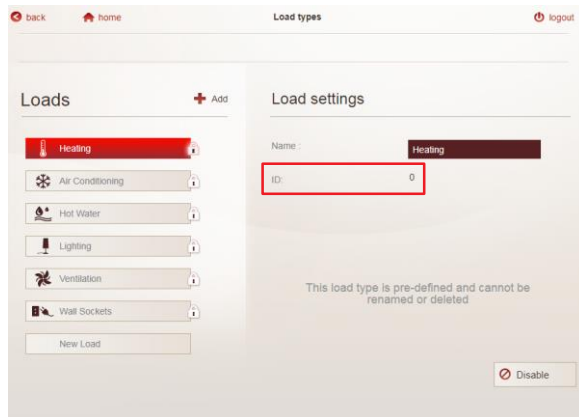

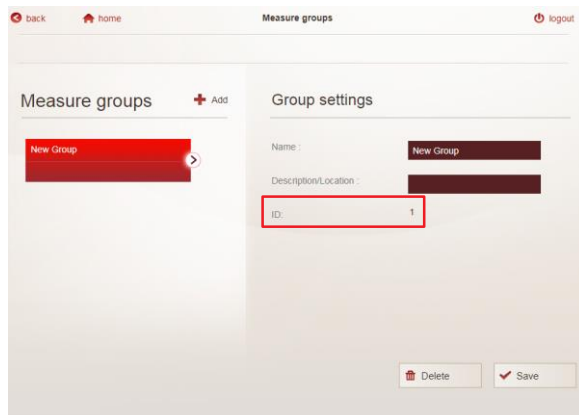

- in the “Measure groups” page for Measure Groups (see image below)



- Description of the device selection button



1. Modbus Address (*fixed value equal to 247*) - Indication of the virtual device type:
247 - 1XXXX = Positive active energy of the Device with ID = XXXX
247 - 2YYYY = Positive active energy of the Load with ID = YYYY
247 - 3ZZZZ = Positive active energy of the Measure Group with ID = ZZZZ
247 - 29999 = Total Positive active energy of all Electrical Loads
2. Name of the device
3. Device status
 -  On
 -  Off
 -  Communication error

8. Use

8.1 Access

The access to the Web Server data is protected by identification codes (PIN and PUK codes).

Four types of "default" users are configured:

- "administrator"
- "greenUp"
- "installer"
- "user"

The home page ("home") will be different depending on the type of user that access to the device.

8.1.1 Access right

- "administrator"

Access to the pages:

- Web Server configuration
- System configuration
- My panel board (display of all measuring/metering devices)
- Consumption: data & diagraph.
- Reports & Data download
- Reports: alarms

Default access PIN code:

- 99999 (5 characters)

Default access PUK code:

- 00000 9999 00000 (14 characters)

- "greenUp"

Access to the pages:

- Web Server configuration
- System configuration
- My panel board (display of all measuring/metering devices)
- Consumption: data & diagraph.
- Green'Up
- Reports & Data download
- Reports: alarms

Default access PIN code:

- 88888 (5 characters)

Default access PUK code:

- 00000 88888 00000 (14 characters)

- "installer"

Access to the pages:

- System configuration
- My panel board (display of all measuring/metering devices)
- Consumption: data & diagraph.
- Reports: alarms

Default access PIN code:

- 55555 (5 characters)

Default access PUK code:

- 00000 5555 00000 (14 characters)

- "user"

Limited access to display pages of data (not configurations possible in mode "user");

- Consumption: data & diagraph.
- Reports: alarms

Default access PIN code:

- 11111 (5 characters)

Default access PUK code:

- 00000 1111 00000 (14 characters)

8.1.2 Creating a new User

Only the users “administrator” and “greenUp” can add new users.

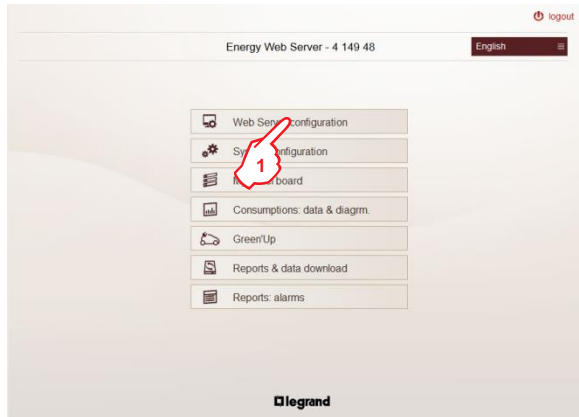

1. Click “Web Server configuration”

Web Server configuration’s page appears

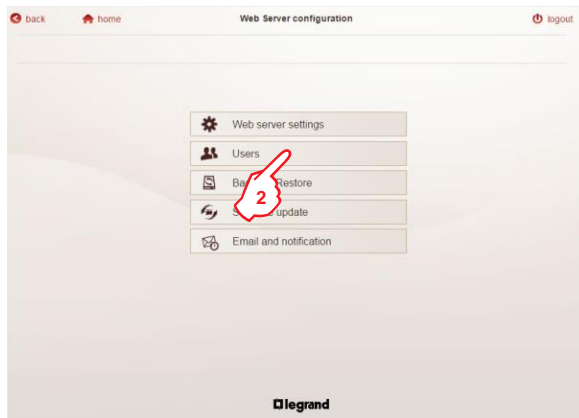

2. Click “Users”

Users configuration page appears

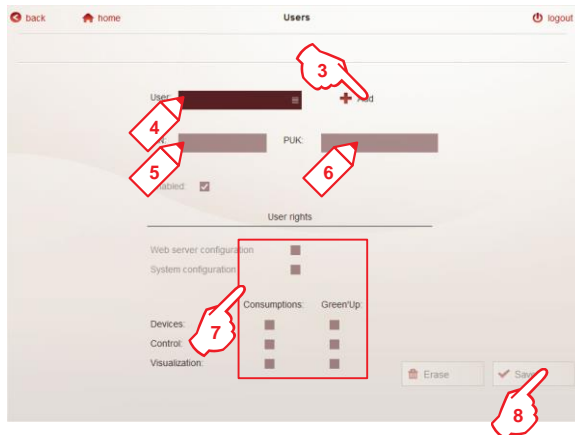

3. Click "Add".
4. Assign a name to the new user.
- 5.- 6. Type the PIN and PUK codes for the new user.
7. Choose which pages the new user can see.
8. Click "Save"

8.1.3 Changing of the access rights

The access rights of a user can be modified only by the users "administrator" or "greenUp"

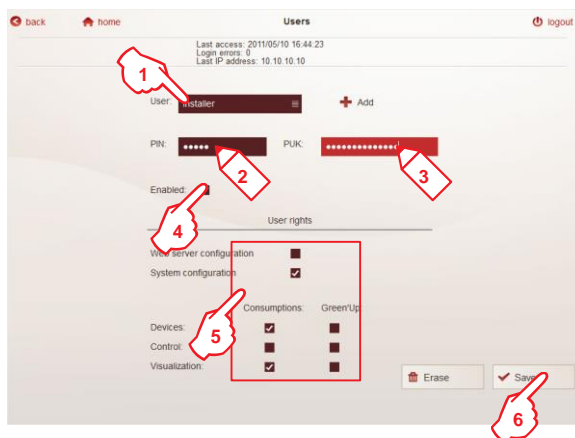

- In the Users configuration page
1. Choose from the list a "name of a user" (ex. installer) to edit it.
 - 2.- 3. Type the PIN and PUK codes for the user to edit.
 4. This option allow to disable a user without erase it once the "Save" button is clicked.
 5. Choose, for the user to edit, which pages it can see.
 6. Click "Save".

8.1.4 Logout procedure

The symbol  **logout** appears on all pages of the web server.

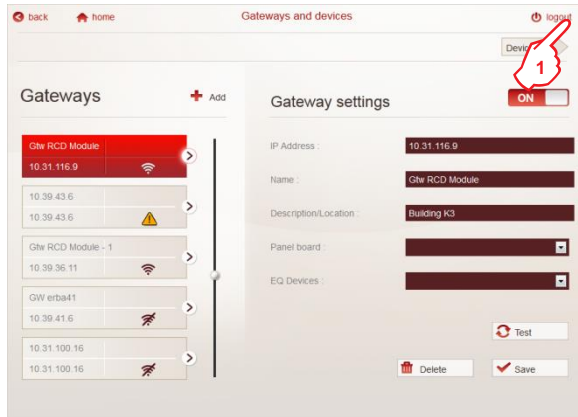

1. Click "logout"

A confirmation page appears.

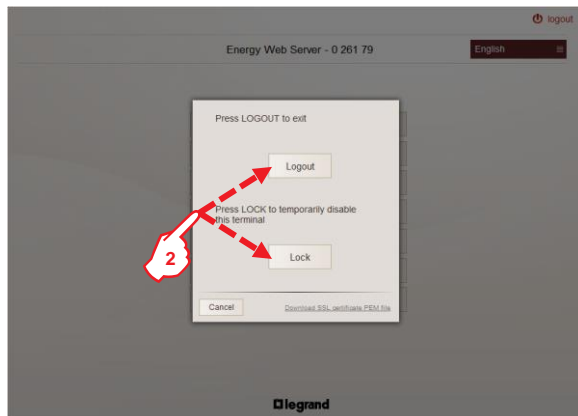

2. Click "Logout" or "Lock" to confirm the exit from the web server.

Note:

Logout → closing the session, reconnection with the PIN code

Lock → temporary disabling of the application, reconnection with the codes PIN+PUK

8.2 Data display pages

8.2.1 My panel board

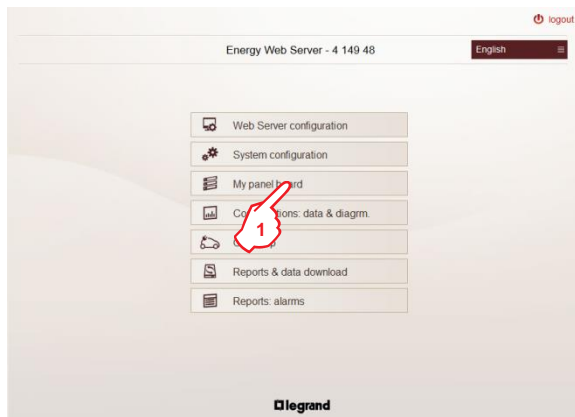

In the Home Page

1. Click "My panel board"

Devices page appears

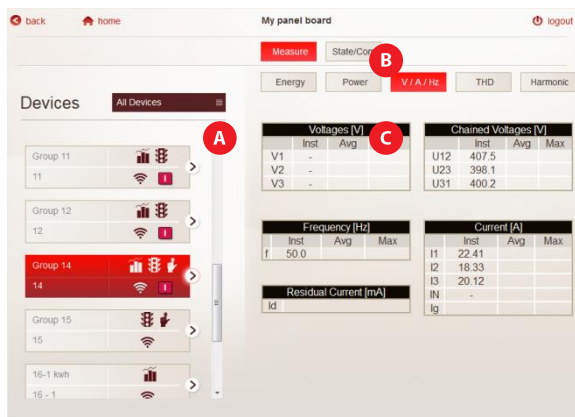

The page is divided into three sections:

section **A** shows the devices added by the users with their characteristics and status icons. It is possible to choose a device per Gateway, Panel board or "All Devices"

section **B** is the area where it is possible to select two pages:

- Measure: display of the quantities measured by a device:
 - Electricity measuring devices: Energy, Power, Voltages / Currents / Frequency, THD (if available on the Device) and Harmonics (if available on the Device)
- State/Com.: page dedicate to EMS CX³ devices; display of devices status, control buttons... for each EMS CX³ device/group of devices

section **C** shows the values measured by the selected device, status icons and command buttons (if available).

For Green'Up users, Devices page is the following:

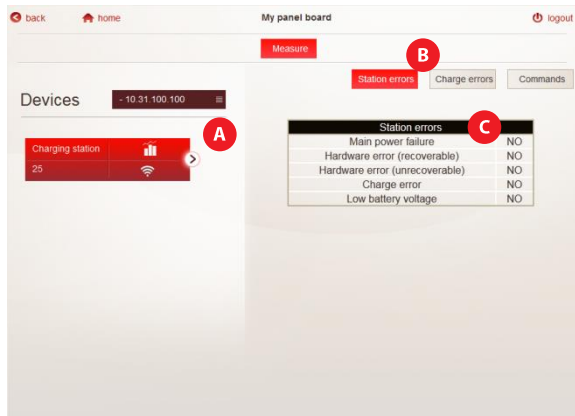

The page is divided into three sections:

section **A** shows the devices added by the users with their characteristics and status icons. It is possible to choose a device per Gateway or "All Devices"

section **B** is the area where it's possible to select which maintenance page of charging station display.

- Station errors
- Charge errors
- Commands

section **C** shows the status of the charging station or of the charging process and offers the possibility to enable or disable the EV plug or Domestic plug.

For “Power Supervision System Devices”, page “My panel board” it is structured as follows:

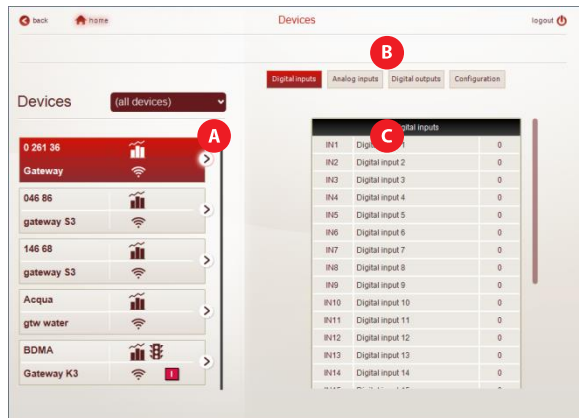

section **A** shows the devices added by the users with their characteristics and status icons

section **B** is the area where is possible to select :

- a page showing the status of digital and analogue inputs (for 0 261 36)
- a page showing the status and for command of the digital outputs (for 0 261 36 and 0 288 12)
- configuration page of outputs

section **C** shows inputs/outputs status, command buttons of outputs and configuration pages

• **CONFIGURATION OF DIGITAL OUTPUTS** (for 0 261 36 and 0 288 12)

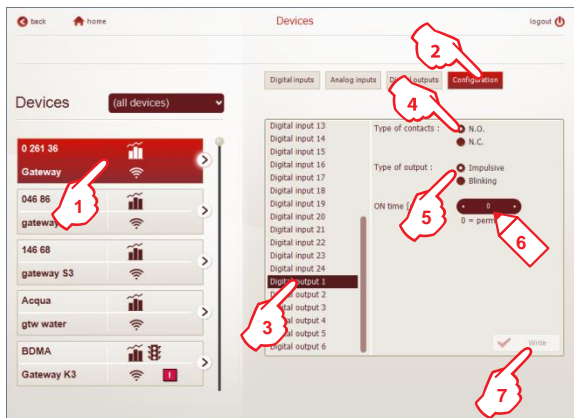







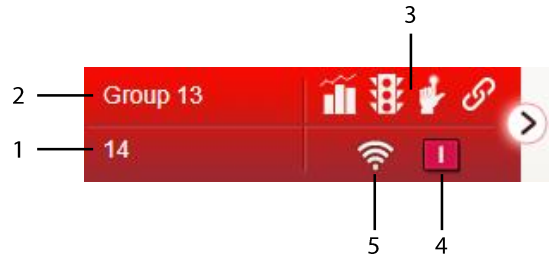



In "My panel board" page:

1. Select a "Power Supervision System" Device
2. Click "Configuration"
3. Select the output to configure
4. Select the "normal state" of the relay:
 - NO: normally open
 - NC: normally close
5. Select the command mode of the selected output:
 - Impulsive: impulsive or maintained command according to the set time ("ON time" of point "6.")
 - Blinking: the relay switches repeatedly with cadence equal to the set time ("ON time" of point "6.")
6. Enter the opening/closing time of the relay (if "ON time" = 0, the command is maintained); **Note:** (the value entered is in "seconds")
7. Click "Write" to confirm the settings

• **Description of the device selection button**



1. Modbus Address (Modbus Address - Position for counters with pulse output or Modbus Address - Side for charging stations "two" sides or Modbus Address - Indication of the virtual device type for the Master/Slave function)
2. Name of the device
3. Symbols of the functions associated to the Device
 -  Measure
 -  State
 -  Command
 -  Link Functionality
4. This symbol appears only if the Device integrates the state function related to a protection device and shows the circuit-breaker state:
 -  Open
 -  Closed
 -  Tripped
5. Device status
 -  On
 -  Off
 -  Communication error
 -  Charging station failure (for charging stations only)

8.2.2 Consumptions: data & diagra.

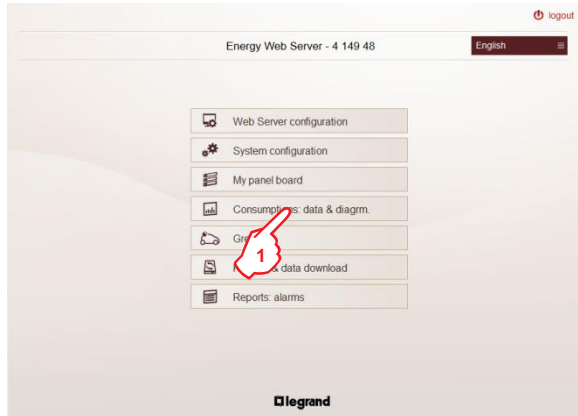

In the Home Page

1. Click "Consumptions: data & diagra."

Consumptions page appears

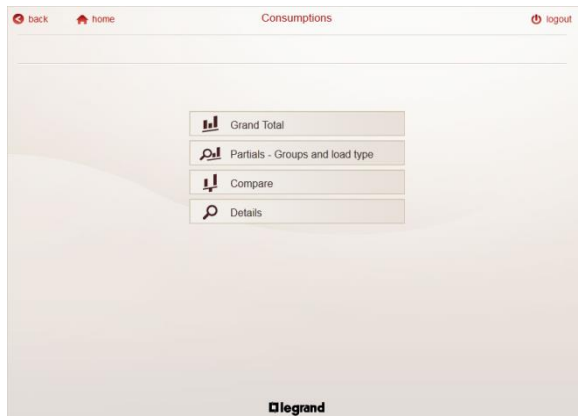

Are available 4 ways of displaying data:

- **Grand Total** (Consumption of the entire installation)
- **Partials** (Consumptions per Load and/or Measure group)
- **Compare** (Comparison of the Global Consumptions between two Devices)
- **Details** (Consumptions of a single Device)

For each page are available:

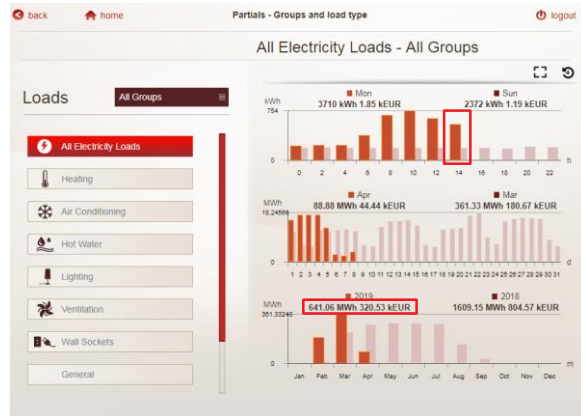

- Histograms of Consumptions divided per:
 - Day (per hour)
 - Month (per day)
 - Year (per month)
- Comparison between the actual and the previous value (ex. today/yesterday, etc.)
- Values in:
 - Wh (and multiples of Wh), dm^3 (and multiples of dm^3) of water, dm^3 (and multiples of dm^3) of gas and "Wh (and multiples of Wh equivalent)" of gas.
 - Note: displayed values (resolution , decimal values, etc.) depend only on the quantities read by the measuring instruments.**
 - EUR (or other configured currency)

8.2.2.1 Grand Total

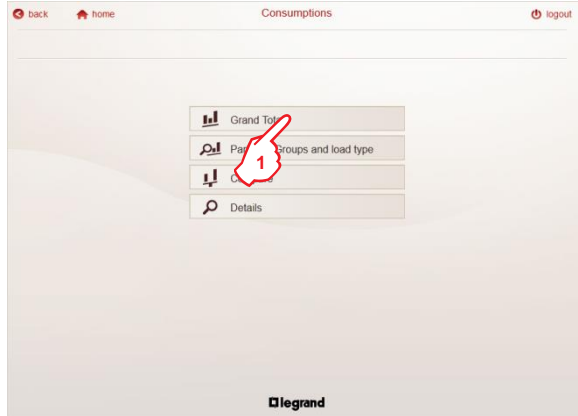

1. Click "Grand total"

Grand total page appears

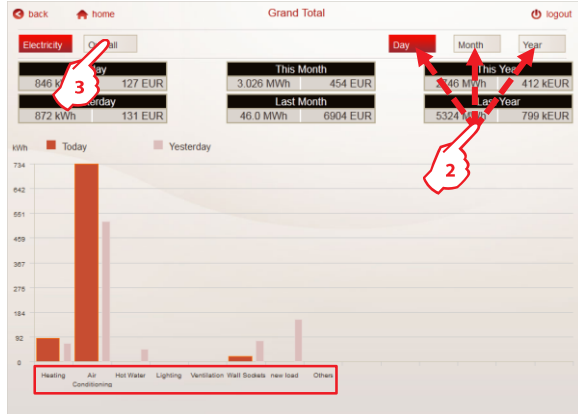

Visualization of Total Energy Consumptions (Ea +) on histograms divided per Load

2. Click "Day", "Month" or "Year" to view the consumptions on a different time period (Day (hours) / Month (days) / Year (months))

3. Click "Overall" to display the page of the Overall Consumptions (Electricity, Gas and Water) of the system.

Note: in this visualization, consumption data for "virtual" devices not excluded from Total are also taken into account.

Overall consumptions page appears

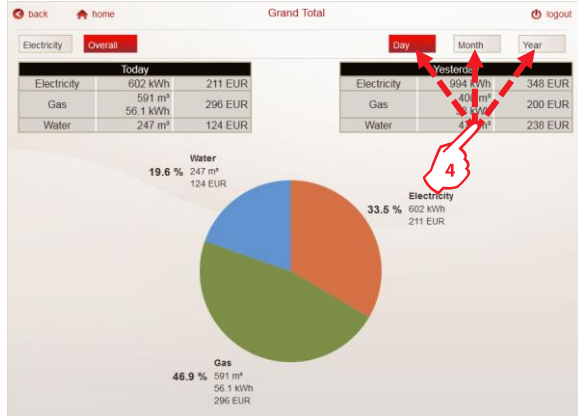

Visualization of the Overall Consumptions of the system on tables and on a pie chart showing:

- consumptions subdivided per type:
 - Electricity (orange area)
 - Gas (green area)
 - Water (blue area)
- consumptions valued according to the measurement unit and the configured currency

4. Click "Day", "Month" or "Year" to view the consumptions on a different time period (Day (hours) / Month (days) / Year (months))

Note: in this visualization, consumption data for "virtual" devices not excluded from Total are also taken into account.

8.2.2.2 Partials - Groups and load type

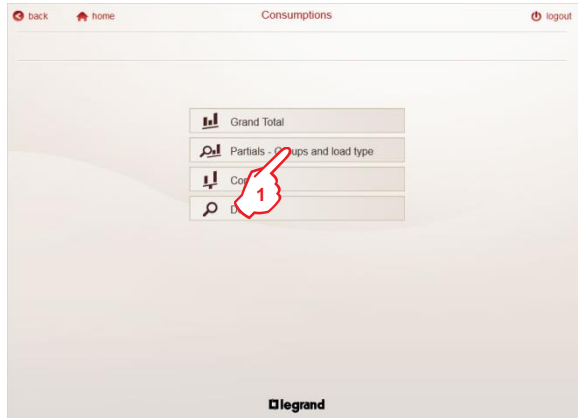

1. Click "Partials - Groups and load type"

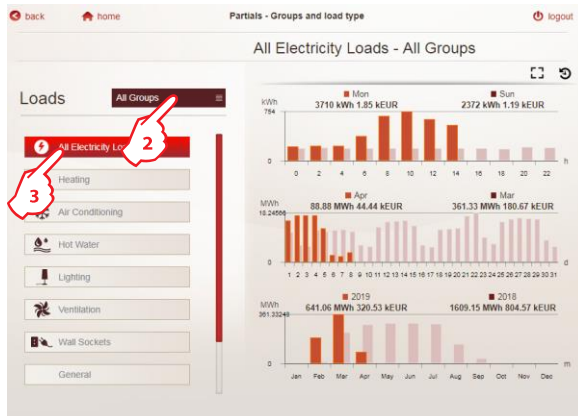

Visualization of Partials Consumptions on histograms per Day / Month / Year

2. Click to view the consumption of a specific Measure group or of "all groups"
3. Click to view the consumption of a specific Load (ex. Ventilation, Water, Gas, ...) or of "All electricity loads"

Note: in this visualization, consumption data of "virtual" devices according to the Loads and/or the assigned Measure Groups are also taken into account.

8.2.2.3 Compare

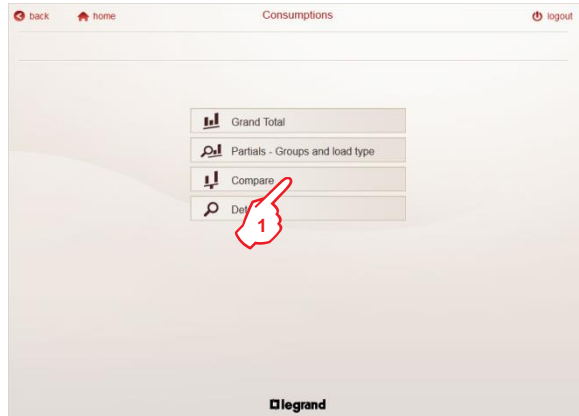

1. Click "Compare"



Comparison of the Consumptions between two Devices.

2. Click to select the two "physical" or "virtual" Devices to compare

Note: Selecting two non homogeneous Devices (ex Electricity and Gas), comparison is evaluated only according to the currency (EUR or other currency) and not according to the measurement units.

It is not possible to compare kWh of energy and "Equivalent kWh of gas.

3. Click "Total" or "Details" to view the Total or Detailed comparison between the two selected Devices

4. Click "Day", "Month" or "Year" to view the consumptions on a different time period (Day (hours) / Month (days) / Year (months))

8.2.2.4 Details

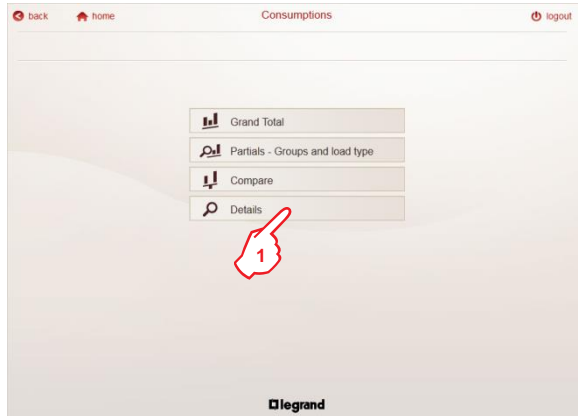

1. Click "Details"



The page is divided into three sections:

section **A** shows the devices added by the users with their characteristics and status icons. It is possible to choose a device per Groups / Loads or "All Devices"

section **B** is the area where is possible to select two pages:

- Measure: display of the quantities measured by a device:
 - Electricity measuring device: Energy, Power, Voltages / Currents / Frequency, THD (if available on the Device) and Harmonics (if available on the Device)
 - Water Counters: Water consumptions
 - Gas Counters: Gas consumptions

• State/Com.: page dedicate to EMS CX³ devices; display of devices status... for each EMS CX³ device/group of devices

section **C** shows the histograms of the consumptions, values measured by the selected device and status icons (if available).

8.2.2.5 Advanced histograms display

For consumptions histograms of the menus “Partial – Groups and Load types” and “Details”, an advanced display mode is available.

- Full screen display

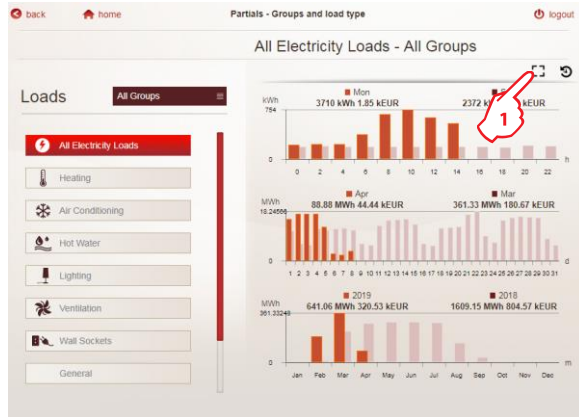

1. Clicking on the button , histograms can be enlarged to full screen. This function can be useful for projecting histograms on screens in public places, processing departments, ... to create an awareness on consumption.

Note: image format and resolution will depend on the screen on which the data will be displayed (see example below for a screen 16:9)



2. To return to the standard format, press the button  at the top right.

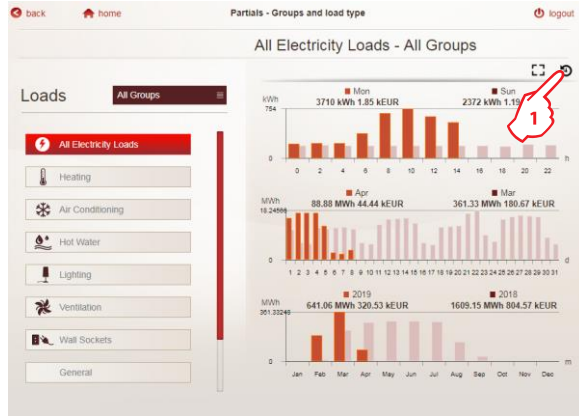

- Detailed view and direct download of data



1. Clicking on the button , it is possible to browse the histograms in detailed mode by:

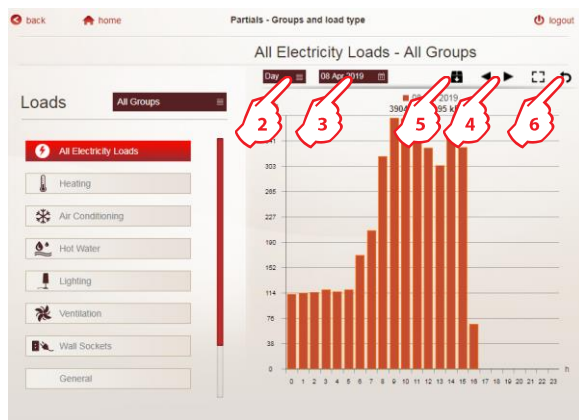







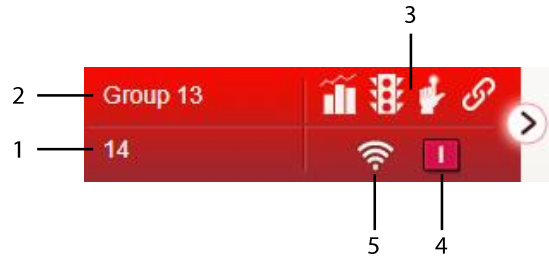

- Day (per hours)
- Month (per days)
- Year (per months)
- 10 years (per years)



2. Click to select the histogram viewing period (Day, Month, Year or 10 years)
 3. Click to choose a specific date in the selected period
 4. Clicking on two arrows (◀ or ▶) it is possible to pass from one to another histogram in the selected period (e.g. today, yesterday, two days ago, ...)
 5. Clicking on the button , it is possible to download a ".csv" file named "datalogger.csv" with the data saved by the web server in the selected period
 6. Click to return to the standard view
- Note:** it is still possible to put in full screen this type of histogram by pressing the button .

• **Description of the device selection button**



1. Modbus Address (Modbus Address - Position for counters with pulse output or Modbus Address - Side for charging stations "two" sides or Modbus Address - Indication of the virtual device type for the Master/Slave function)
2. Name of the device
3. Symbols of the functions associated to the Device
 -  Measure
 -  State
 -  Command
 -  Link Functionality
4. This symbol appears only if the Device integrates the state function related to a protection device and shows the circuit-breaker state:
 -  Open
 -  Closed
 -  Tripped
5. Device status
 -  On
 -  Off
 -  Communication error

8.2.3 Link Function

This function allows you to link two EMS CX³ modules to create automatic actions between a module that generates an event and a module that performs an action as a result of the event; these automations, once programmed, can run independently without a connection to a manager is needed.

Programming is done using the EMS CX³ configuration software. The Web Server can see which links are created between the EMS modules.

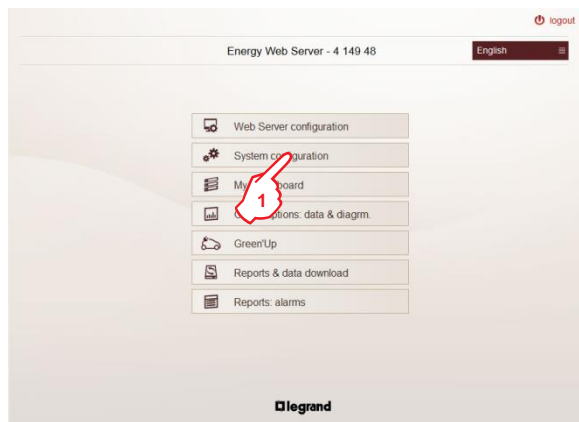

In the Web Server's home page

1. Click "System configuration"

System configuration page appears

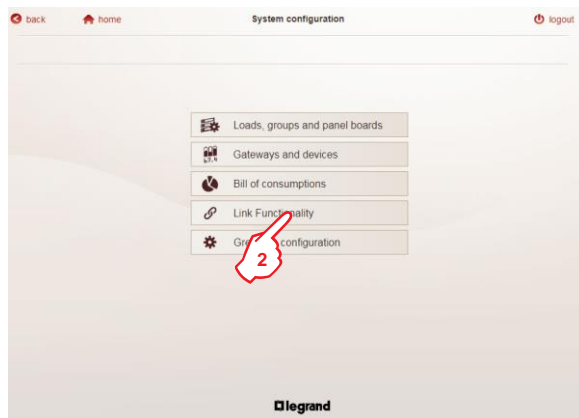

2. Click "Link Functionality"

Link functionality page appears

In this page are shown the existing links between the EMS CX³ modules configured in the Web Server:

- on the left, modules that generate events

- on the right, modules that generate actions in response to the events

Each module is indicated with its name, function, name of the Gateway under which is the EMS module and the Modbus address of the EMS module

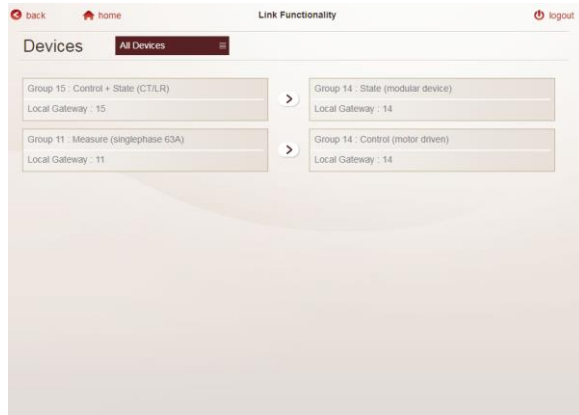

In case of an error an alert icon is displayed.

Note: to check and correct errors it is necessary to use the EMS CX³ configuration software.

At the same time, the symbol  appears in the device selection button to indicate that there is one or more modules that have been configured as part of a Link

8.3 Green'Up

In the Web Server's home page

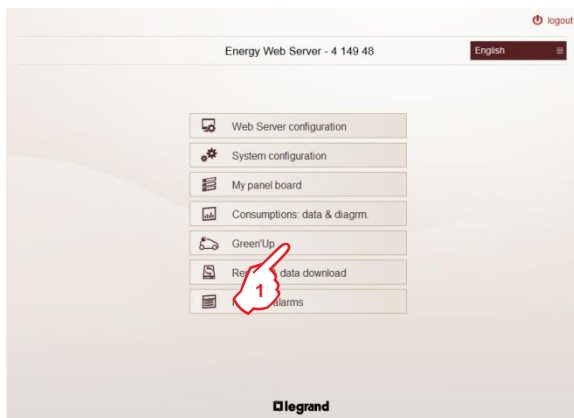

1. Click "Green'Up"

Green'Up's management page appears

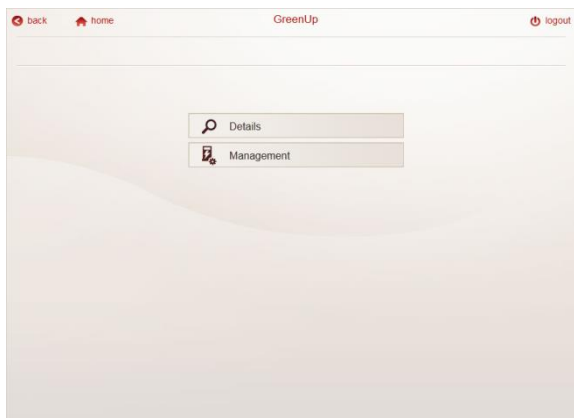

8.3.1 Details

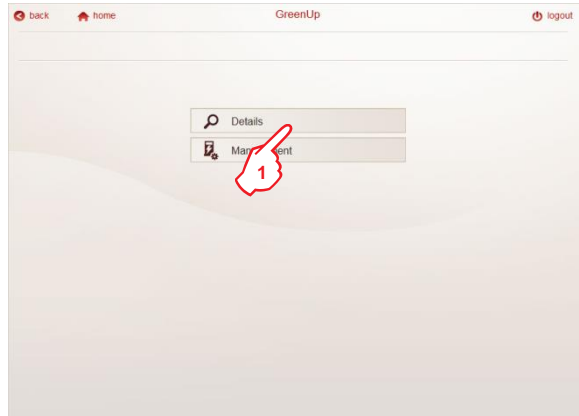

In the Green'Up's management page

1. Click "Details"

Green'Up details page appears.

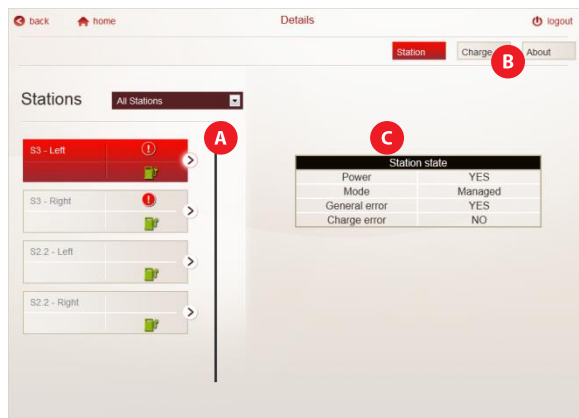

The page is divided into three sections:

section **A** shows the Charging stations added by the users with their characteristics and status icons. It is possible to choose a charging station per "Groups" or "All Devices"

section **B** is the area where it's possible to select the details of the selected station

– Station: shows the state of the selected station (station powered-on, managed, in error, etc.)

– Charge: shows the state of the charging process (station available or busy, etc.)

– About: shows the information about the station and its characteristics (rated current, firmware and hardware version, etc.)

section **C** shows the information about the selected charging station.

8.3.2 Management

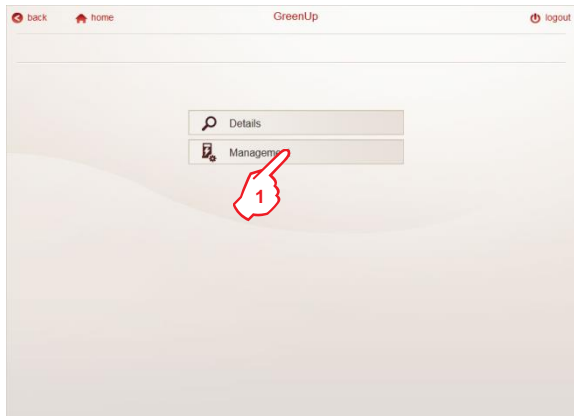



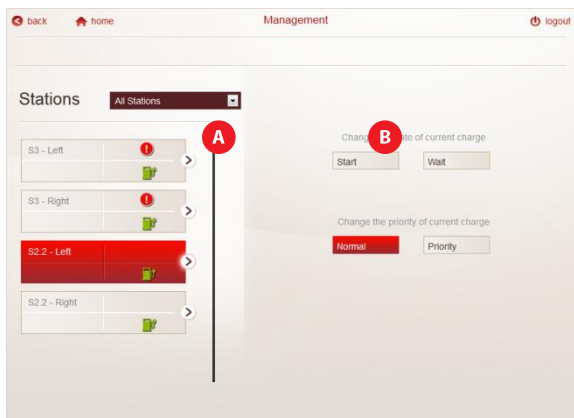



In the Green'Up's management page
1. Click "Management"
 Green'Up management page appears.



The page is divided into two sections:
 section **A** shows the Charging stations added by the users with their characteristics and status icons. It is possible to choose a charging station per Priority / Groups or "All Devices"
 section **B** it's possible to manage:
 – the state of the current charging process for the selected station/side of station: Start / Wait
 – the priority of the current charging process for the selected station/side of station : Normal / Priority
Note: these two settings affect only the current charging process. They don't change the default parameters of the stations!

• Description of the Device selection button



1. Measure Group
2. Name of the Charging station
3. Error's icons
 -  Communication error
 -  Charging station failure. The detailed list of the errors is displayed in the Devices menu (see 8.2.1)
4. State of the charging station:
 -  charging station available and ready to start a charging process
 -  charging in progress
 -  charging station in wait mode
5. Priority of the charging station/side of the charging station
 - no symbol: Normal
 -  Priority charging station

8.4 Historical of consumptions

All the measured quantities are saved automatically in files “.CSV” compatibles with Excel or “csv” reader.

It could be necessary to export these files to manipulate the information; to do this are required some settings in the Web server.

8.4.1 CSV files options

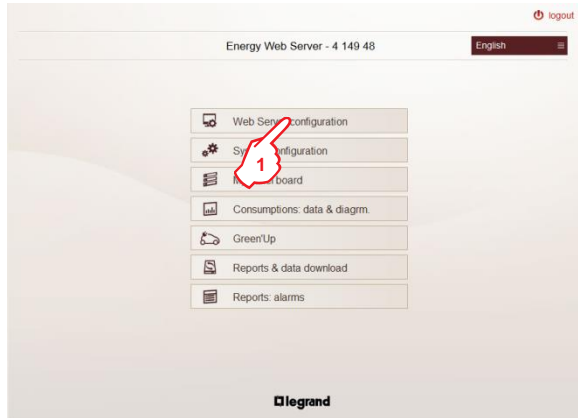

In the Web Server's home page

1. Click “Web Server configuration”

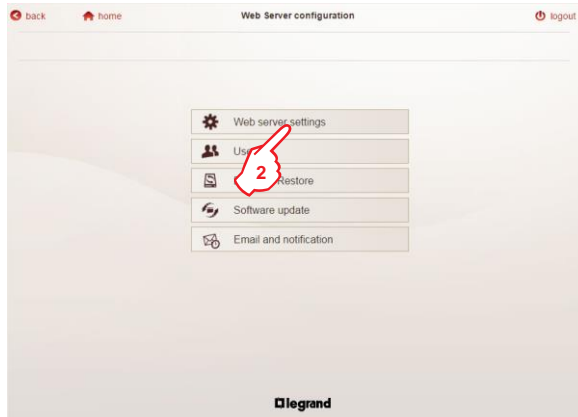

2. Click “Web server settings”

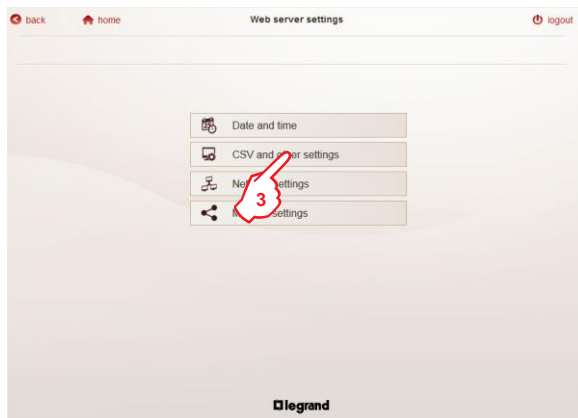

3. Click “CSV and other settings”



4. Click to set the CSV decimal separator: "point" or "comma" (default)
5. Click to set the CSV fields separator: "comma" or "semicolon" (default)
6. It's possible to change the default password (default password: wsmeasure) used to access to the CSV files contained in the HDD of the Web Server. (See 8.4.2)
7. Click "Save"

Note: The system restart automatically when settings are saved.

8.4.2 Access to CSV files

Access to CSV files contained in the HDD of the Web Server, it is possible via File Transfer Protocol (FTP):

• ACCESS VIA FTP

Type the command [FTP://"Web Server IP Address"](ftp://Web Server IP Address) (ex. [FTP://172.168.1.101](ftp://172.168.1.101)) in the Web browser or in the "address area" of a folder; an intermediate page appears.

User name and password are requested:

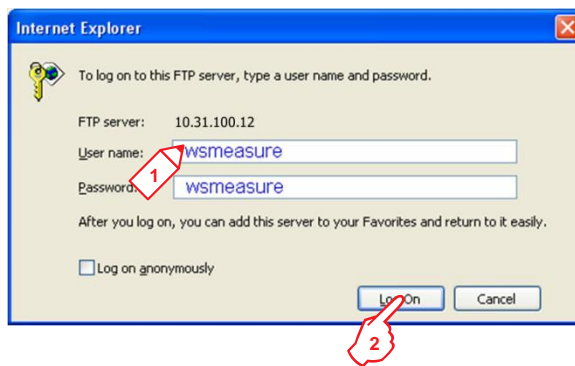

1. Type the requested fields
 - User name: type "wsmeasure" (default user name; not changeable by the user).
 - Password: type "wsmeasure" (default password) or "password modified by the user" (see 8.4.1)
2. Click "Log On"

Access to the server by web browser allows you to view and/or saving single "CSV" files only.

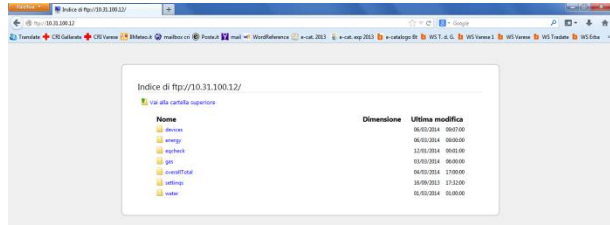

For the full download of all "CSV" files at once, access to the web server via the "address area" of a folder.

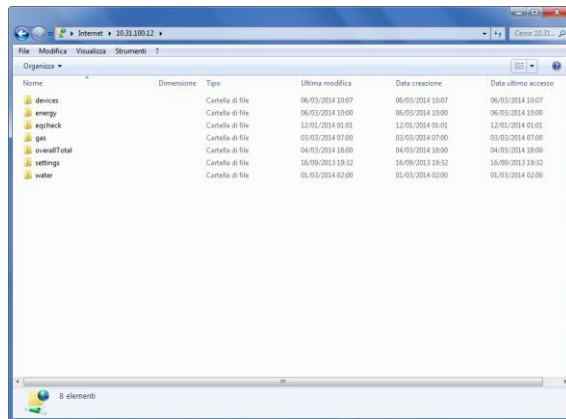







8.4.3 Management of CSV files

CSV files are created automatically according to the settings done by the user in "System Configuration".

Files are saved in the HDD of the Web Server in the following sub-folders:

- "devices": contains the data recorded by each device (multifunction device, energy meter, etc.)
- "energy": contains data related to energy consumption Ea+ (files are recorded per "all devices" / "Loads" / "Groups")
- "eqcheck": contains information on the energy quality (according to EN 50160) read by a device set as "Eq device" in Gateways and Devices (see page 36)
- "gas": contains data related to gas consumption (files are recorded per "Devices" and "Groups")
- "overall Total": contains data related to total consumptions of electricity, gas and water
- "settings": contains files which show the system structure detailed per IP and Modbus addresses, groups, loads, etc.
- water: contains data related to water consumption (files are recorded per "Devices" and "Groups")

 devices	06/03/2014 10:07
 energy	06/03/2014 10:00
 eqcheck	12/01/2014 01:01
 gas	03/03/2014 07:00
 overallTotal	04/03/2014 18:00
 settings	16/09/2013 19:32
 water	01/03/2014 02:00

Notes:

- all consumption values are saved in Wh for Electricity data and dm³ for Water and Gas data
- saved values (resolution, decimal digits, etc.) depend only on the quantities read by the measuring instruments.

8.4.3.1 "devices" folder

It contains a folder for each device set in the system.

Folder name: "Device ID"



Each device folder contains a series of ".csv" files named "ID_type of data recorded_sampling period"

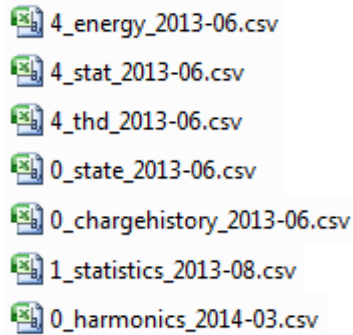

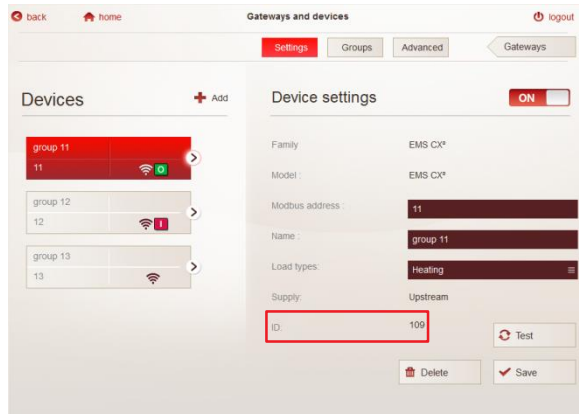

- ID: (identification number of the "physical" or "virtual" device in the database) is a unique number assigned to the device during the system configuration and it is shown in the Gateway and devices page (see image below)
- type of data recorded: energy, gas, water, statistics, states, THD, charge history, etc.
- sampling-period: year-month of recording



8.4.3.2 "energy" folder

It contains a series of ".csv" files with the recording of energy consumptions subdivided per "Devices", "Groups" and "Loads".
Files name "type_sampling period_file version"

 devices_2013-06_3.csv groups_2013-06.csv loads_2013-06.csv

- type: consumptions distributed per devices, groups or loads
- sampling period: year-month of recording
- file version: increases in case of changes in the system configuration (adding of a Load/Group/etc.)

8.4.3.3 "eqcheck" folder



It contains a file named
"eqcheck_sampling period_file version"

 eqcheck_2013_1.csv

- sampling period: year of recording
- file version: increases in case of changes in the system configuration (changing of EQ device)

8.4.3.4 "gas" folder

It contains a series of ".csv" files with the recording of gas consumptions subdivided per "Devices" and "Groups"
Files name "type_sampling period_file version"



 devices_2013-10_7.csv groups_2013-11.csv

- type: consumptions distributed per devices or groups
- sampling period: year-month of recording
- version: increases in case of changes in the system configuration (adding of a Group/etc.)

8.4.3.5 "overall total" folder

It contains a series of ".csv" files with the recording of total consumptions of energy, gas and water

Files name "type_sampling period"

 overallTotalCosts_2014-03.csv overallTotalValues_2014-03.csv

- type: consumptions distributed per cost (currency set) or per values (kWh of energy, m³ of gas and m³ of water)
- sampling period: year-month of recording

8.4.3.6 "settings" folder

It contains two files which show the system structure detailed per Gateways IP, Modbus addresses, groups, loads, etc.

 EnergySettings.csv

 General.csv

 GreenUpSettings.csv

8.4.3.7 "water" folder

It contains a series of ".csv" files with the recording of consumptions subdivided per "Devices" and "Groups"

Files name "type_sampling period_file version"

 devices_2013-10_7.csv

 groups_2013-11.csv

- type: consumptions distributed per devices or groups
- sampling period: year-month of recording
- version: increases in case of changes in the system configuration (adding of a Group / etc)

8.5 Reports & data download

8.5.1 Data Download

This function allows you to directly export consumption data in “.csv” format for a single device, a group of devices or for all devices installed in the system.

In the Web Server’s home page

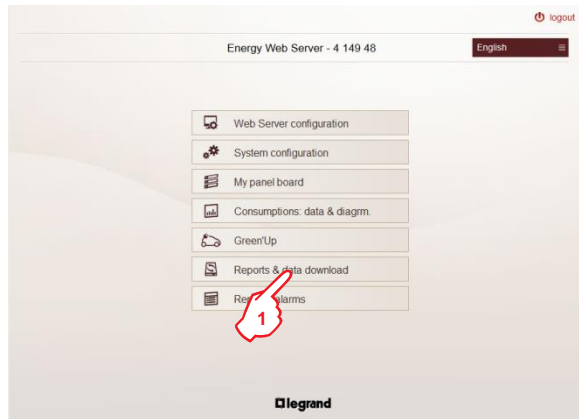

1. Click “Data download and reports”

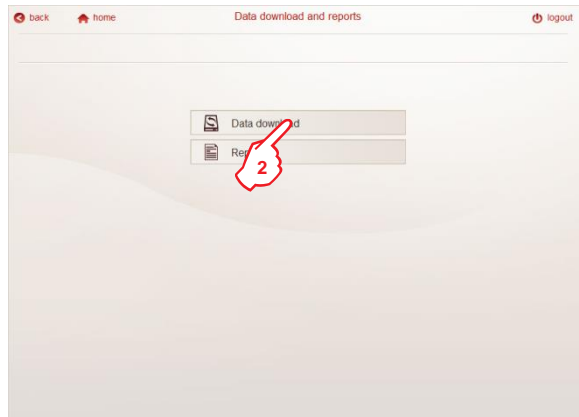

2. Click “Data download”

Data download settings page appears

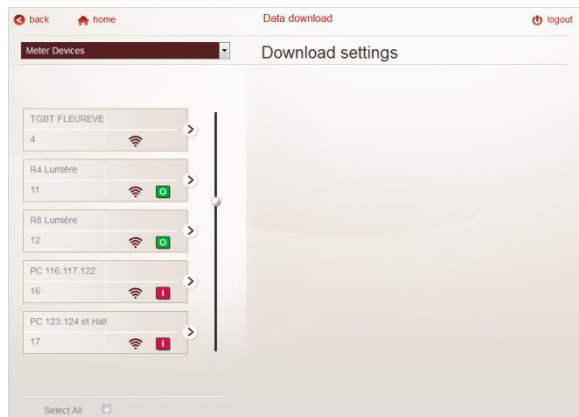

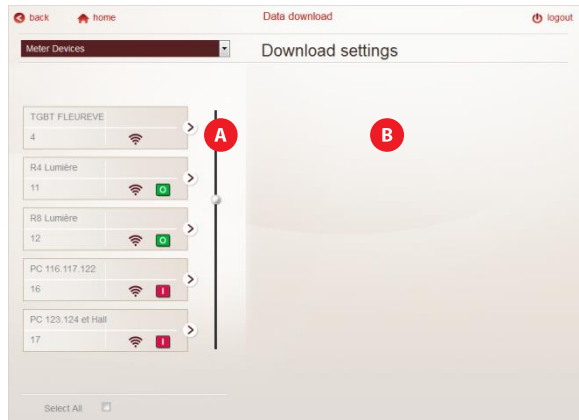

The page is divided into two sections:

section **A** shows the “physical” or “virtual” devices added by the users with their characteristics and status icons. It is possible to create a list of Meter devices, Charging station(s) for EV (for Green UP user), Groups or Loads

section **B** is the area where, once performed a selection, is possible to set:

- starting and ending date of the reference period
- whether to include in the download also costs file(s)
- sample rate: 15 minutes (default), 1 hour or 1 day

To download csv files:

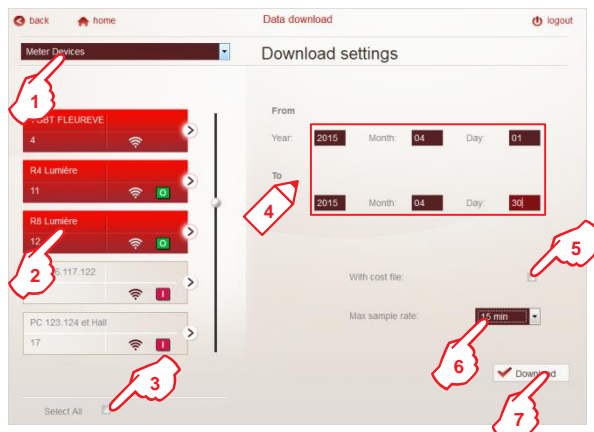

1. Click to select the list type that will be displayed: Meter Devices (default), , Charging station(s) for EV (for Green UP user), Groups or Loads
2. Click to select Devices, Charging stations, Groups or Loads one by one (objects selected are highlighted in green) or 3. click “Select All” to select all Devices, Charging stations, Groups or Loads at once
4. Type starting and ending date
5. Click if you want to include in the download also a file with costs
6. Choose the sample rate according to which consumption and costs data will be grouped
7. Click “Download” to complete the process

An intermediate window with file(s) creation progress appears

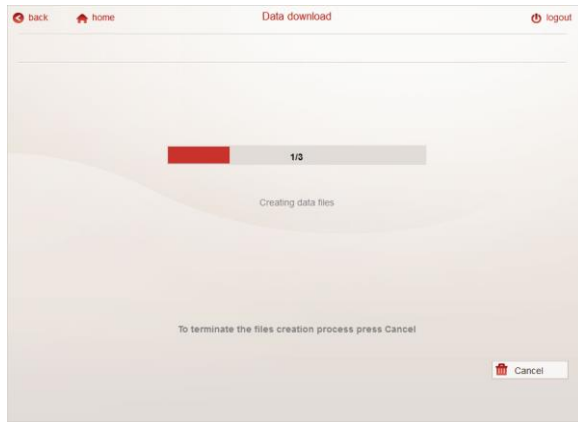

At the end of file creation process

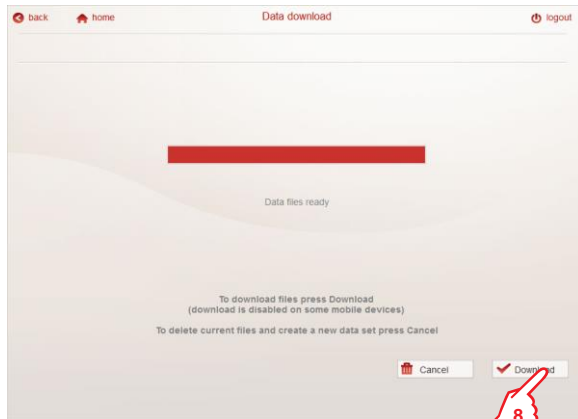

8. Click "Download"

A pop-up window appears

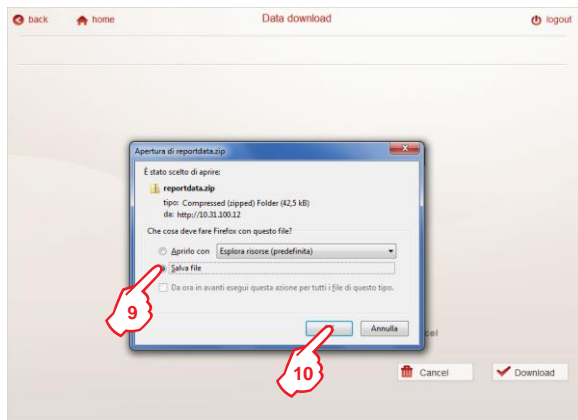

9. Click to save the file on your computer , then 10. click "OK"

Files are now downloaded on your computer from the web server's database in an archive named "reportdata.zip".

Note: files will contain only data correctly saved on the database of the software; if a device is in communication error state or the web server is not running properly, consumption data won't be present on downloaded files.

In the .zip archive you can find a file with consumption data and a file with costs data for each consumption type: electricity, gas and water for the selected Device(s) / Load(s) or Group(s)

report_energy_devices_electricity.csv	20/05/2015 13:29
report_energy_devices_electricity_cost.csv	20/05/2015 13:29
report_energy_devices_gas.csv	20/05/2015 13:29
report_energy_devices_gas_cost.csv	20/05/2015 13:29
report_energy_devices_water.csv	20/05/2015 13:29
report_energy_devices_water_cost.csv	20/05/2015 13:29
report_energy_groups_electricity.csv	20/05/2015 13:29
report_energy_groups_electricity_cost.csv	20/05/2015 13:29
report_energy_loads.csv	20/05/2015 13:28
report_energy_loads_cost.csv	20/05/2015 13:28

Note: all consumption values in “csv” files are saved in Wh for Electricity data and dm³ for Water and Gas data

To perform a new csv files download

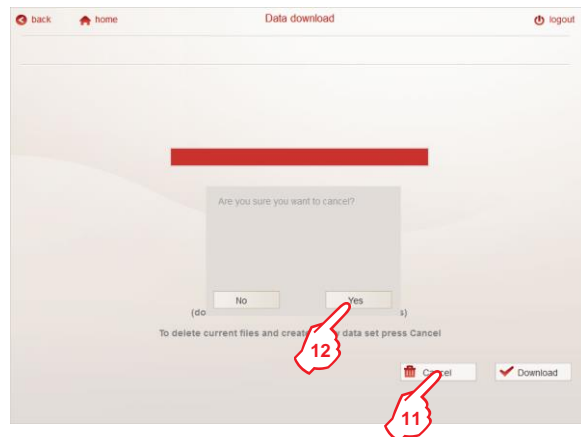

11. Click “Cancel”

A pop-up window appears

12. Click “Yes” to return to the Data download settings page

8.5.2 Reports

This function allows you to create a “.pdf” report starting from data contained in the database saved of the web server.

Two types of reports are available:

- a general report, monthly or yearly, containing overall consumption data of the system divided per type: Electricity, Gas and Water
- a detailed report, monthly or yearly, containing consumption data of the selected Device(s).

In the Web Server’s home page

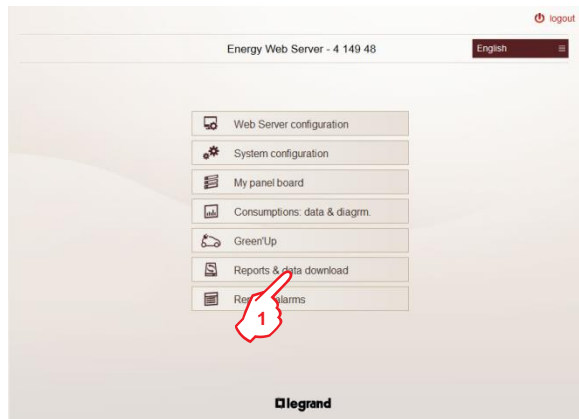

1. Click “Data download and reports”

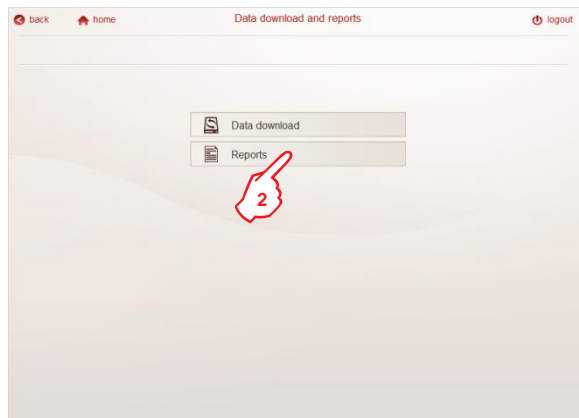

2. Click “Reports”

Reports settings page appears

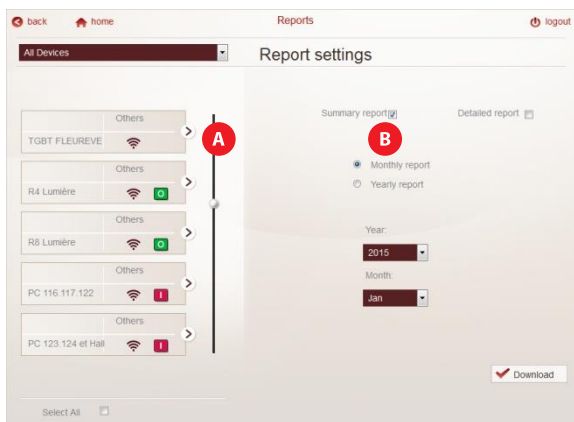

The page is divided into two sections:

section **A** shows the “physical” or “virtual” devices added by the users with their characteristics and status icons

section **B** is the area where it is possible to select:

- which type of report: Summary or Detailed
- the report period: Monthly or Yearly report
- specific month and year

To create a Summary report:

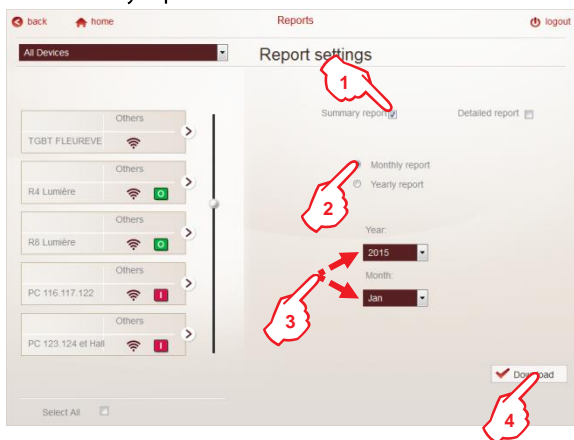

To create this kind of report it is not necessary to select any device because this is a general document that contains Overall consumption data.

1. Select “Summary report”
2. Click to choose the report period: monthly or yearly
3. Choose month and year (for monthly reports) or only the year (for yearly reports)
4. Click “Download” to complete the process

A pop-up window appears

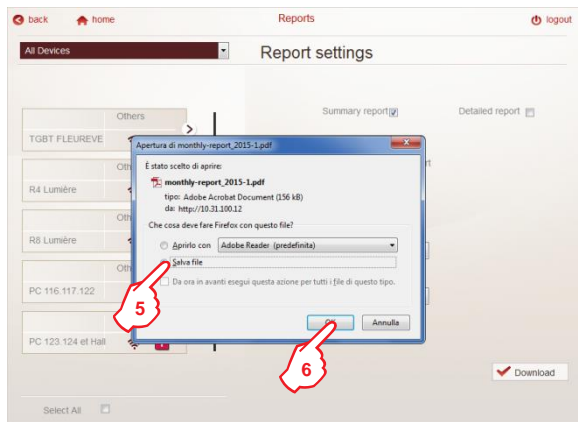

5. Click to save the file on your computer , then 6. click “OK”

The file is now downloaded on your computer from the web server’s database.

Note: files will contain only data correctly saved on the database of the software; if a device is in communication error state or the web server is not running properly, consumption data won't be present on downloaded files.

In the destination folder you can find a file named:
“Report type and period”

monthly-report_2014-12.pdf

yearly-report_2014.pdf

- report type: monthly or yearly report
- period: year-month (for monthly reports) or year (for yearly reports)

To create a Detailed report:

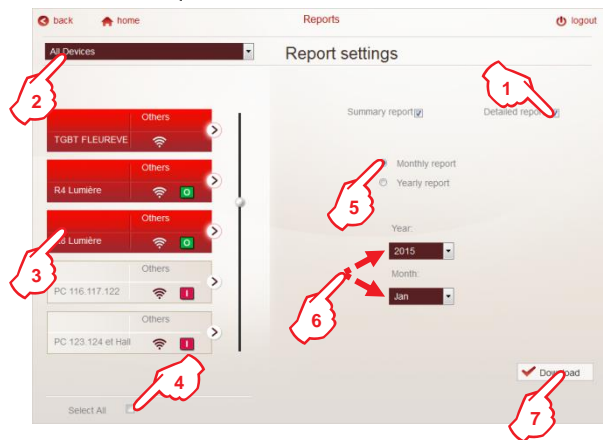

1. Select “Detailed report”
 2. Click to filter the Devices list per Groups / Loads or “All Devices”
 3. Click to select Devices one by one (objects selected are highlighted in green) or 4. click “Select All” to select all Devices at once
 5. Click to choose the report period: monthly or yearly
 6. Choose month and year (for monthly reports) or only the year (for yearly reports)
 7. Click “Download” to complete the process
- A pop-up window appears

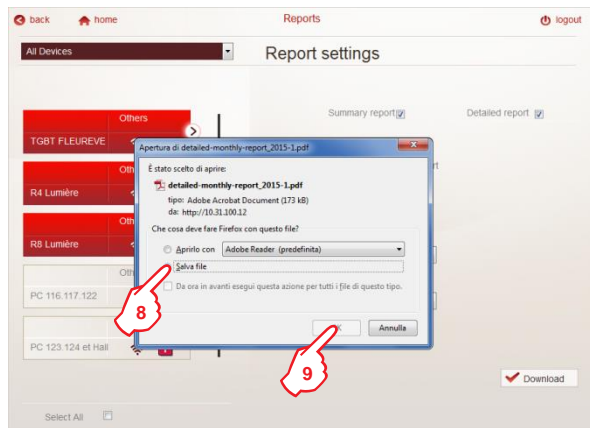



8. Click to save the file on your computer , then 9. click "OK"

The file is now downloaded on your computer from the web server's database.

Note: files will contain only data correctly saved on the database of the software; if a device is in communication error state or the web server is not running properly, consumption data won't be present on downloaded files.

In the destination folder you can find a file named:
"Report type and period"

 detailed-monthly-report_2014-12.pdf

 detailed-yearly-report_2014.pdf

- report type: monthly or yearly report
- period: year-month (for monthly reports) or year (for yearly reports)

8.6 Pushing e-mail and notifications

This function allows you to send via e-mail, monthly or yearly, to one or several e-mail address(es) an automatic reports in “.pdf” or in “.csv” format. To do this are required some settings in the Web server.

8.6.1 E-mail settings

In the Web Server’s home page

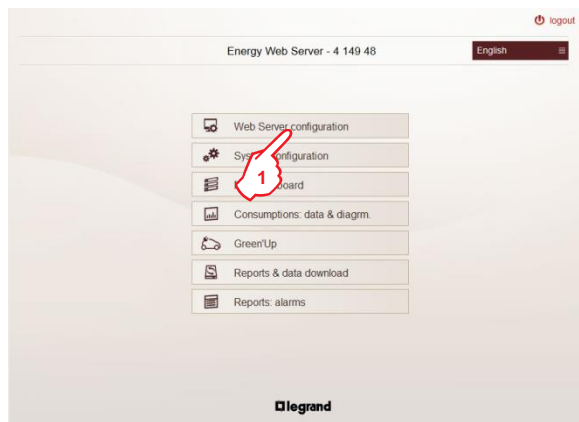

1. Click “Web Server configuration”

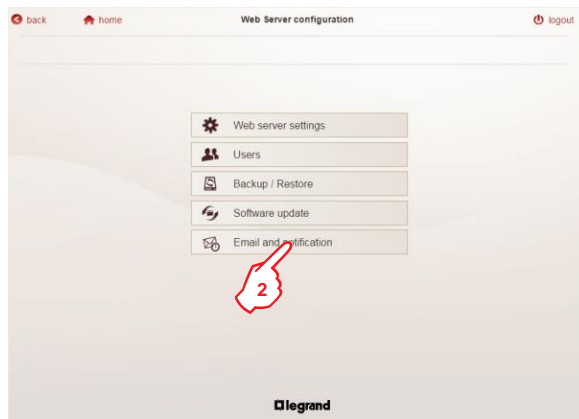

2. Click “Email and notification”

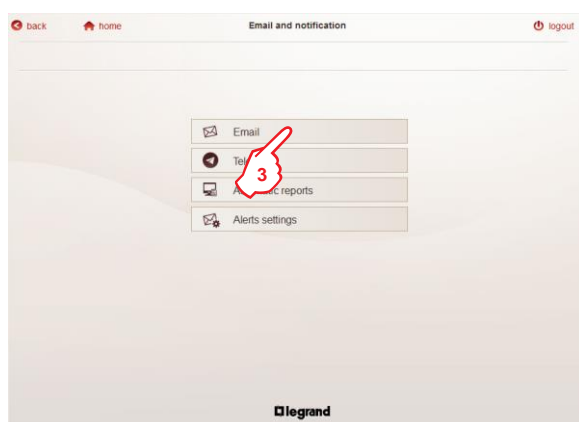

3. Click “Email”

Email configuration page appears

This page is used to configure the sender e-mail profile; e-mail recipients will receive messages containing alerts, events, reports, ... with the email address configured here as "sender".

1. Type the sender complete e-mail address (ex. abc@gmail.com)
 2. Type the others e-mail account elements:
 - User: is the user name with which the sender access to his e-mail account
 - Password: is the password with which the sender access to his e-mail account
 - SMTP server name: is the Simple Mail Transfer Protocol name of the e-mail provider (ex. for gmail: smtp.gmail.com).
 - SMTP server port: optional setting used if the SMTP server port indicated by the provider is different from the default port value (port 465).
 3. Enable SSL: Secure Sockets Layer is an encryption system that is used by all those organizations that need to transit safely and indecipherable data, so that only the intended recipient can view it. Enable this option if it's indicated by your e-mail provider.
- Note:** the elements of points 2. and 3. are obtainable from your email provider or, for the main providers, by internet with a search engine looking for the SMTP characteristics for the outgoing mail.
4. Click "Save"
 5. Clicking "Test" a sample e-mail is sent to the sender e-mail address set in this page in order to test the connection/configuration

8.6.2 Telegram

In the Web Server's home page

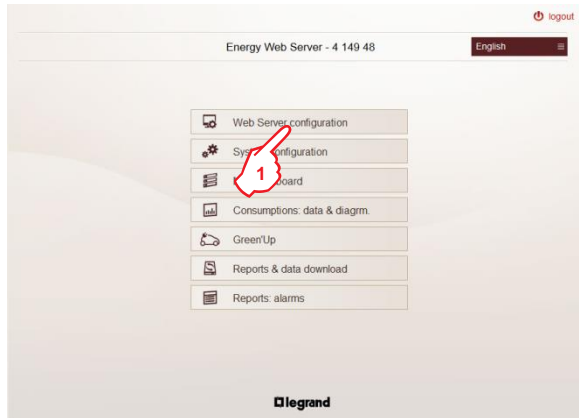

1. Click "Web Server configuration"

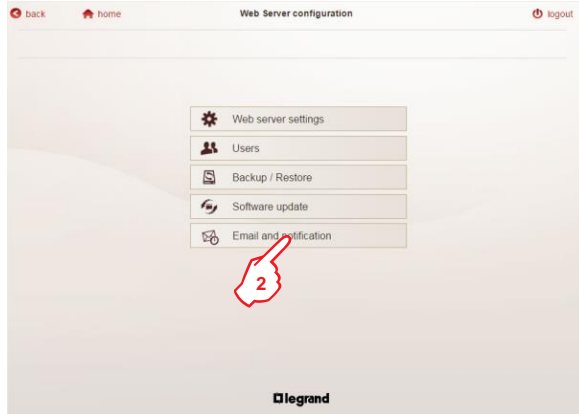

2. Click "Email and notification"

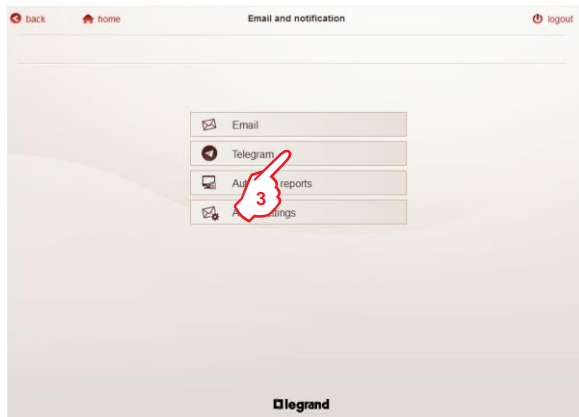

3. Click "Telegram"

Telegram configuration page appears

Telegram is a cloud-based mobile and desktop messaging application with a focus on security and speed

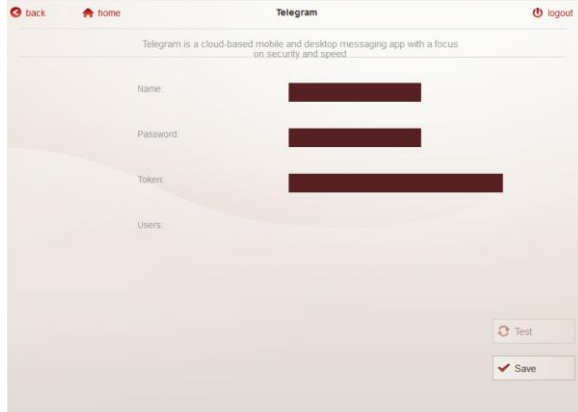

This page is used to configure the sender Telegram profile; Telegram users will receive messages containing alerts, events, ... with the Telegram BOT configured here as "sender".

Procedure:

1. Download the application (available for free for Android, iOS and Windows phones) on your smartphone and follow the installation process and the user profile configuration
2. Create the BOT Telegram using the procedure described on the application site (<https://core.telegram.org/bots#3-how-do-i-create-a-bot>). **Note:** BOT is a simply Telegram account used to create services.

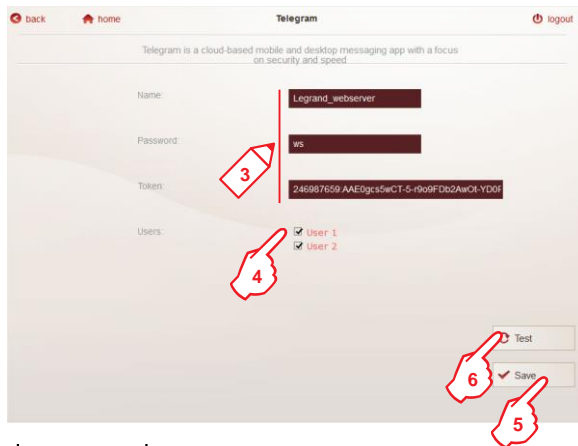

3. Type the account elements :

- Name: name set in the BOT configuration process
- Token: unique alphanumeric code created during the BOT configuration process; It is used to identify univocally the BOT
- Password: it is created and inserted directly on this page; it is used to recognize users enabled to receive notifications from the Web server

Note: in this page will also appear the list of all users who have requested to receive notifications.

4. Click to enable/disable sending notifications to each Telegram user
5. Click "Save"

6. Clicking "Test" a sample message is sent to all selected Telegram users in order to test the connection/configuration

Note: a telegram user, to be enabled to receive notifications from the Web server, will have to open the Telegram app on its smartphone and send to the BOT a message containing the **password** configured in this web page.

8.6.3 Automatic reports

In the Web Server's home page

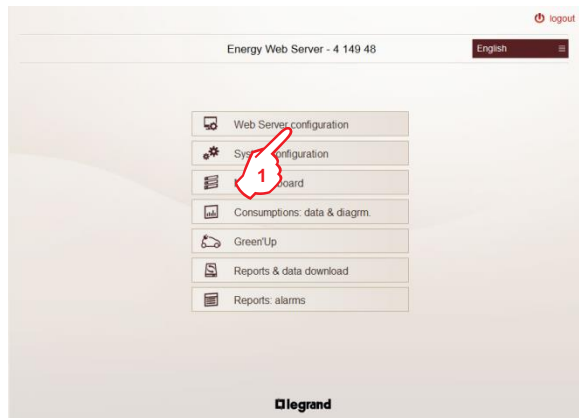

1. Click "Web Server configuration"

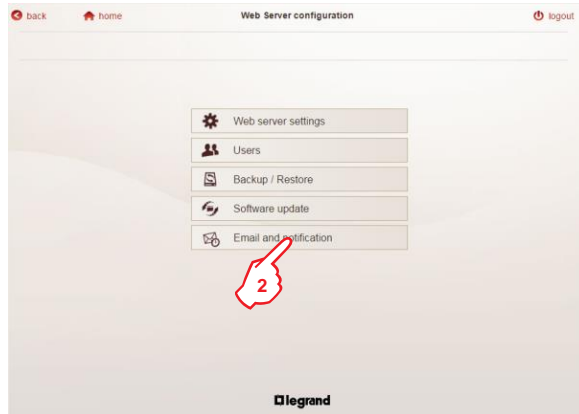

2. Click "Email and notification"

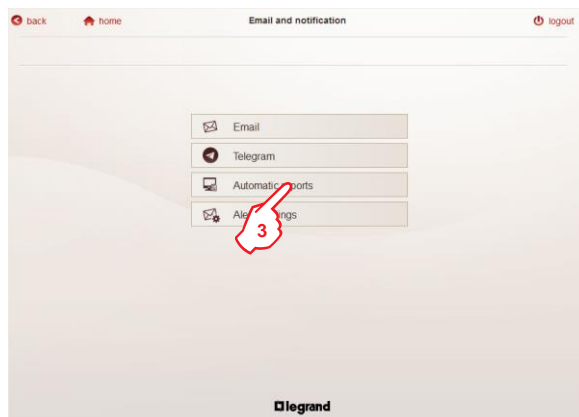

3. Click "Automatic reports"

Automatic report configuration page appears

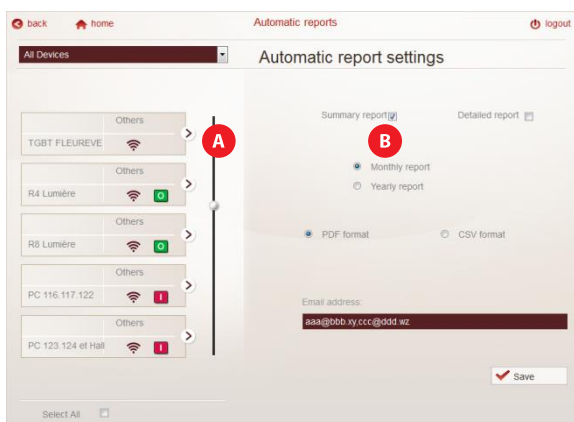

The page is divided into two sections:

section **A** shows the “physical” or “virtual” devices added by the users with their characteristics and status icons

section **B** is the area where it is possible to select and set:

- which type of report: Summary or Detailed
- the report period: Monthly or Yearly report
- the report format: pdf or csv
- the e-mail address(es) of recipient(s).

Note: to enter multiple email addresses, use the comma (,) as separator (ex. aaa@bbb.xy,ccc@ddd.wz)

To set the sending of a Summary report:

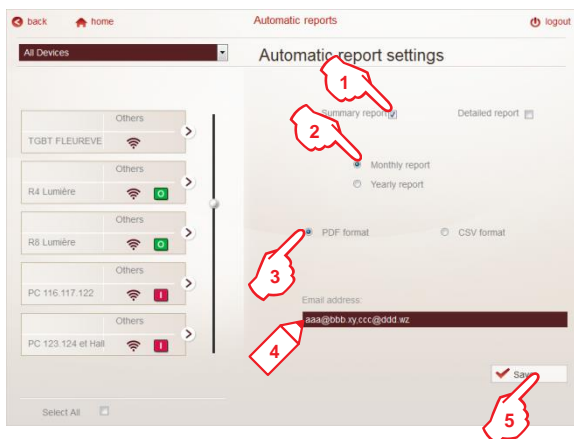

To create this kind of report it is not necessary to select any device because this is a general document that contains Overall consumption data.

1. Select “Summary report”
2. Click to choose the report period: monthly or yearly
3. Click to choose the report format: pdf or csv
4. Type e-mail address(es) of recipient(s)
5. Click “Save” to complete the process

According to the selected period recipient(s) will receive monthly or yearly a Summary report

To set the sending of a Detailed report:

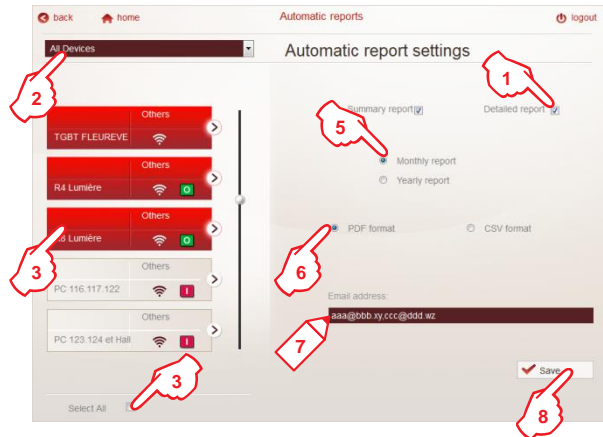

1. Select "Detailed report"
2. Click to filter the Devices list per Groups / Loads or "All Devices"
3. Click to select Devices one by one (objects selected are highlighted in green) or 4. click "Select All" to select all Devices at once
5. Click to choose the report period: monthly or yearly
6. Click to choose the report format: pdf or csv
7. Type e-mail address(es) of recipient(s)
8. Click "Save" to complete the process

According to the selected period recipient(s) will receive monthly or yearly a Detailed report

8.6.4 Alert settings

In the Web Server's home page

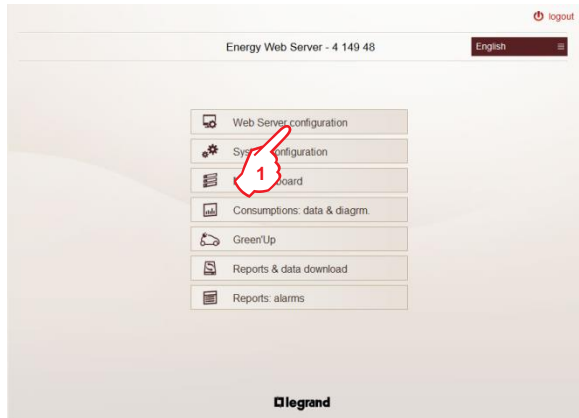

1. Click "Web Server configuration"

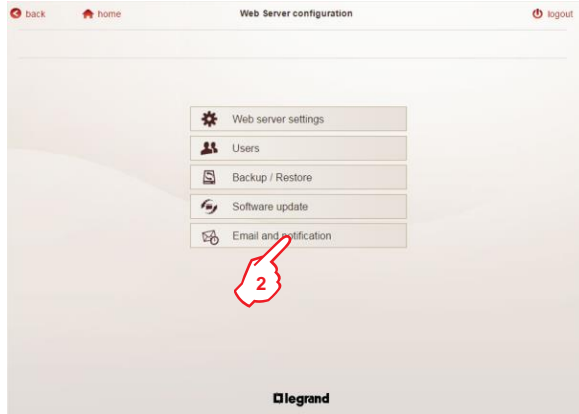

2. Click "Email and notification"

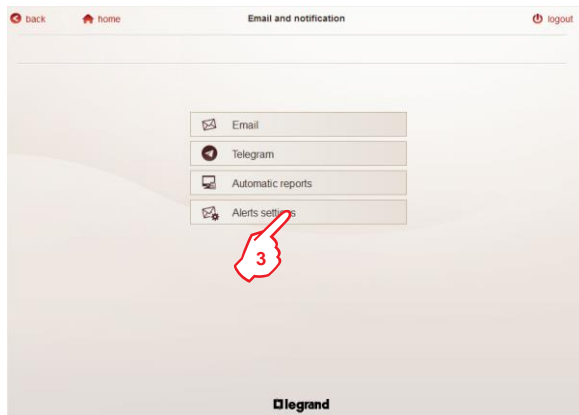

3. Click "Alert settings"
Alert settings page appears

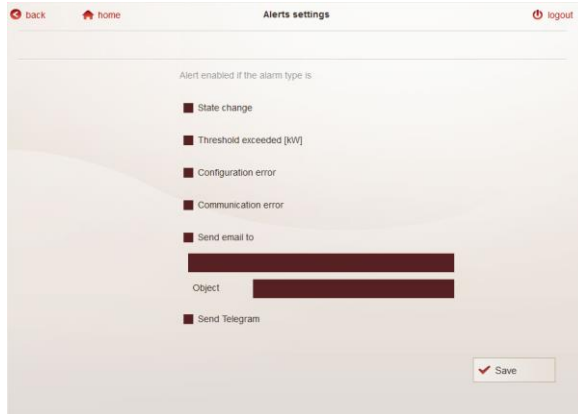

Page dedicated to EMS CX³ devices.

This page is used to set the type(s) of alarm/event for which are sent e-mail or Telegram messages

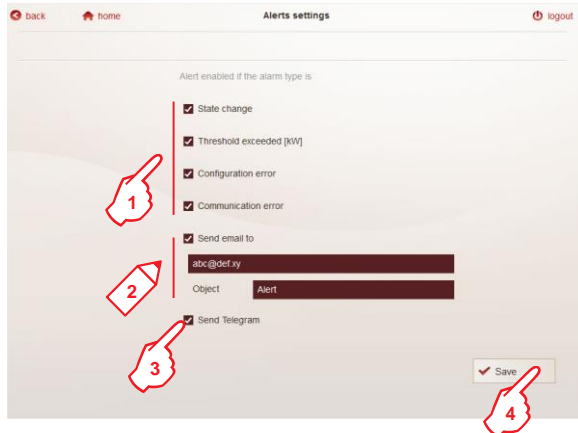

1. Select error/event causing the sending of e-mail or Telegram messages:

- State change
- Threshold exceeded
- Configuration or installation error
- Communication error

2. Flag "Send email to" and type e-mail address(es) of recipient(s) and the object of the e-mail message if you want to send alert e-mail

3. Flag "Send Telegram" if you want to send alert Telegram messages

4. Click "Save"

8.7 Reports: alarms

This function allows the automatic creation and display of the list of alarms, events, ... , registered by each Modbus RS485/EMS CX³ interface (cat.no 4 149 40) installed in the system.

In the Web Server's home page

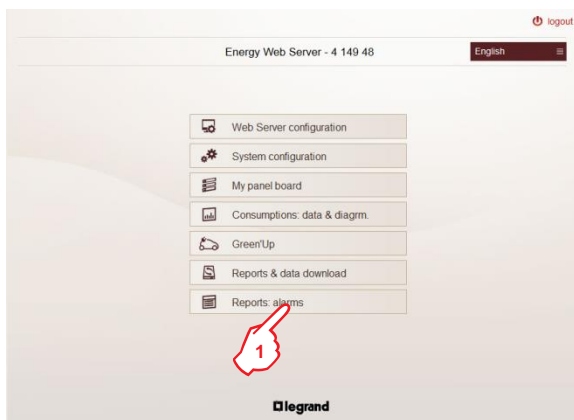

1. Click "Reports: alarms"

The page with the list of registered alarms appears

Time	Device	Address[gw.modbus]	Type
24-11-2016 17:07:55	Lighting	127.0.0.1 : 21	TRIPPED

The page shows:

- Data & Time of the alarm, event, ...
- Name assigned to the device/group of devices EMS CX³
- Name of the Gateway and Modbus address of the device/group of devices EMS CX³ in which the event occurred
- Type of alarm/event: e.g. Tripped, Duplicated function, Communication error, ...

9 Backup and Restore

These procedures are used to create a backup of the device configuration and to perform the restore of a saved configuration.

9.1 Backup procedure

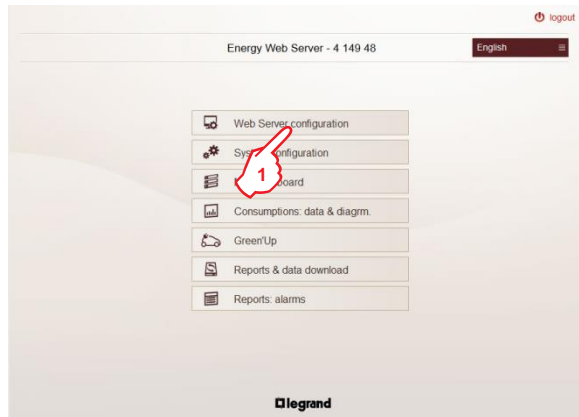

In the Web Server's home page

1. Click "Web Server configuration"

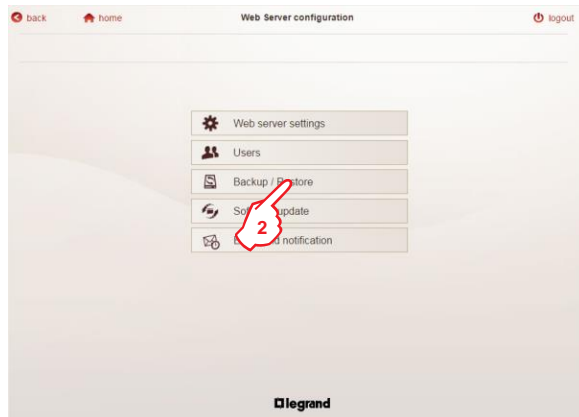

2. Click "Backup/Restore"

Backup and restore page appears

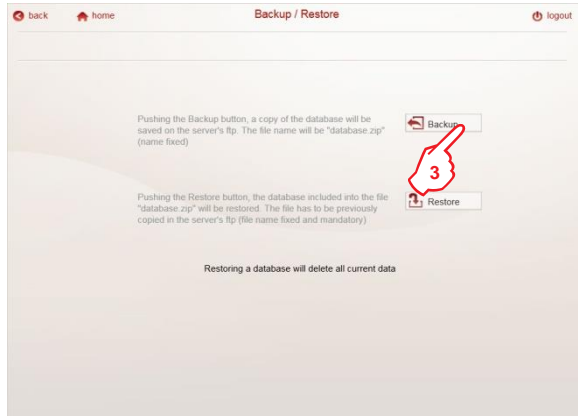

3. Click "Backup" to access the page

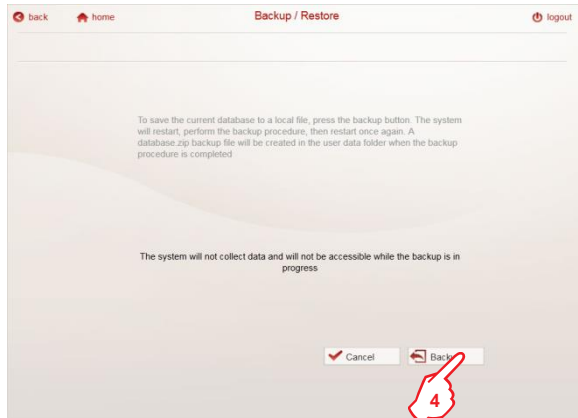

4. Click "Backup" to perform the function.









A file named "database.zip" is automatically saved on the HDD of the web server. It's possible to save in local the file by accessing to the HDD via FTP or Network drive (see 8.4.2)

devices	06/03/2014 10:07
energy	06/03/2014 10:00
eqcheck	12/01/2014 01:01
gas	03/03/2014 07:00
overallTotal	04/03/2014 18:00
settings	16/09/2013 19:32
water	01/03/2014 02:00
database.zip	06/03/2014 11:02

Note: not modify the zip folder's name and its contents to avoid problems during the restore procedure! (names and types of files, etc..)

9.2 Restore procedure

1. Copy the file to restore "database.zip" in the Web server's FTP

 devices	06/03/2014 10:07
 energy	06/03/2014 10:00
 eqcheck	12/01/2014 01:01
 gas	03/03/2014 07:00
 overallTotal	04/03/2014 18:00
 settings	16/09/2013 19:32
 water	01/03/2014 02:00
 database.zip	06/03/2014 11:02

In the Web Server's home page

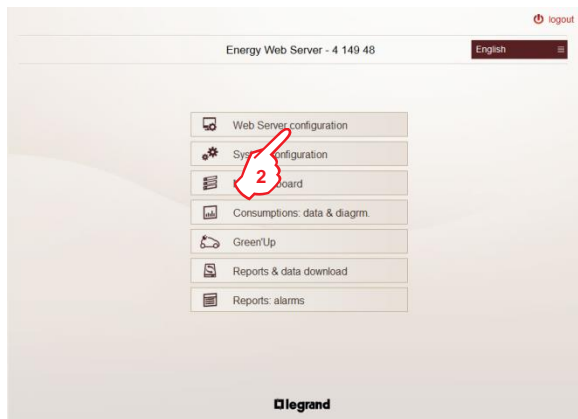

2. Click "Web Server configuration"

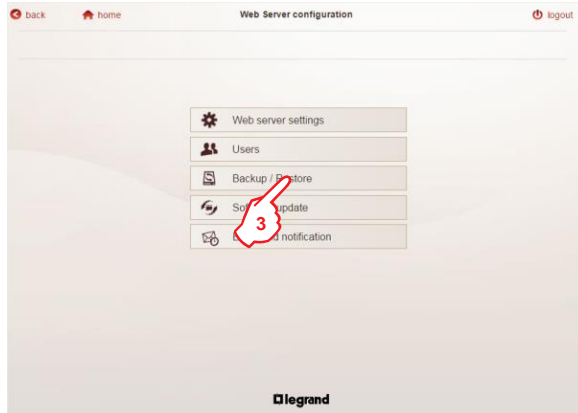

3. Click "Backup/Restore"

Backup and restore page appears

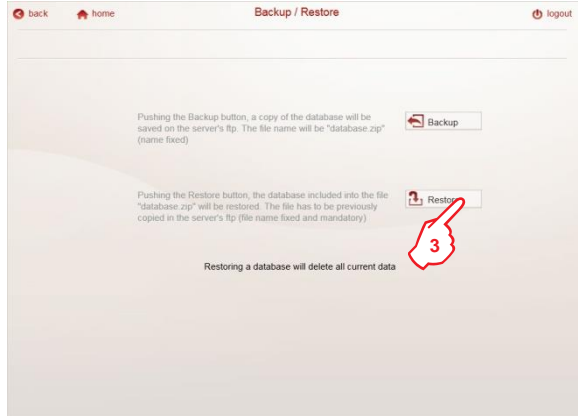

4. Click "Restore" to access the page

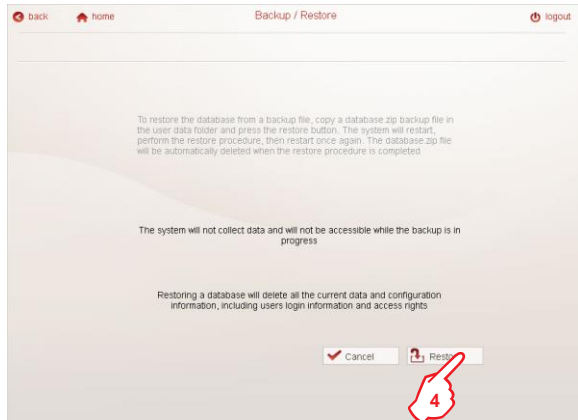

5. Click "Restore" to perform the function.

Note: the good result of the operation will be guaranteed only if the folder's name and its contents has not been modified after the backup (names and types of files, etc..).

10. Network type and access mode

10.1 LAN/intranet

Private network

Addresses and rights managed by the Manager of the Building

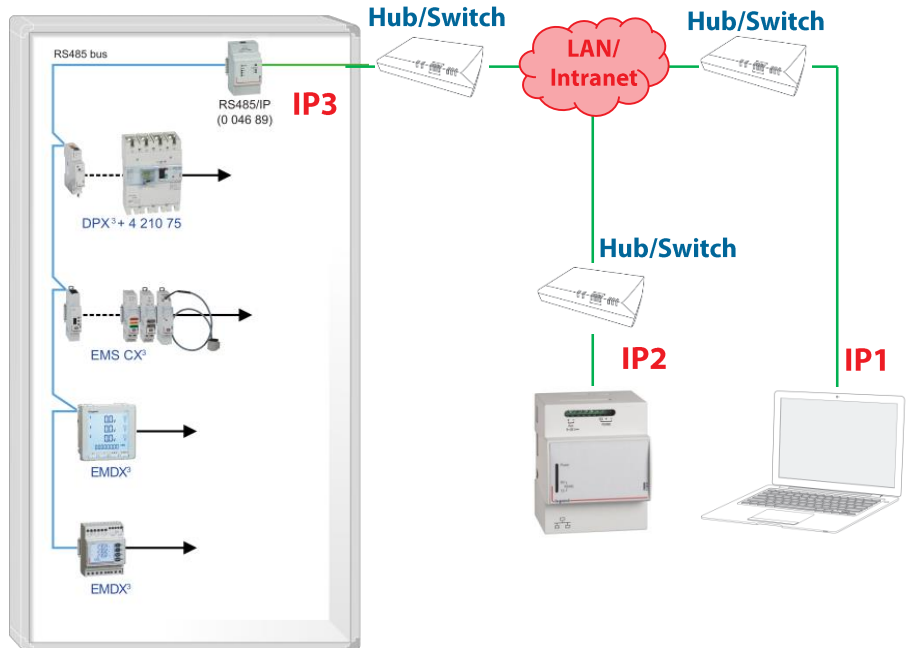

10.1.1 Ports

- Web Server to Gateways or to Slave Web servers:
 - Port 502, Modbus TCP

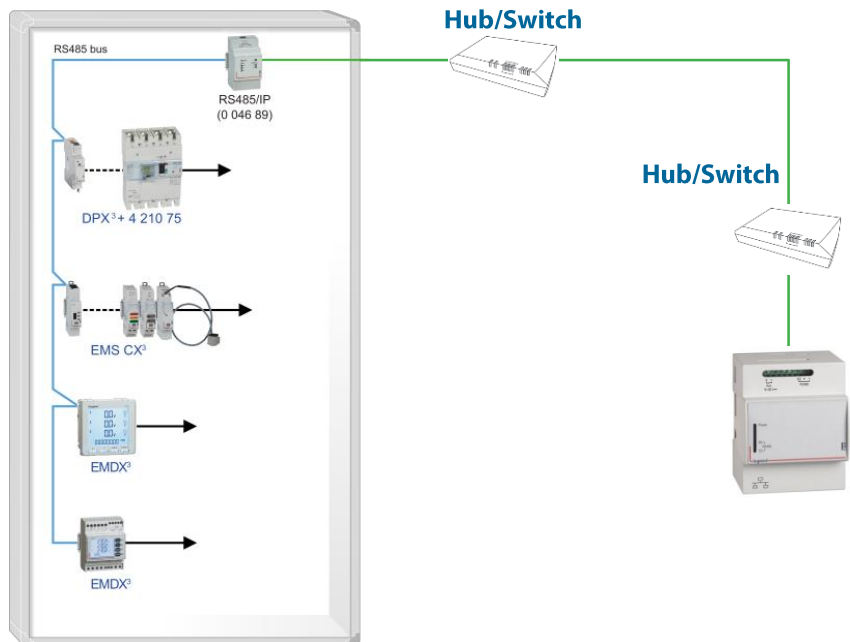

- Users to Web Server:
 - Port 80, HTTP (<http://IP2> by web browser)
 - Port 443, HTTPS (<https://IP2> by web browser)
 - Port 443, Telegram
 - Ports 20 and 21, FTP (<ftp://IP2> by web browser or in "My Computer")
 - Port 502, Modbus over IP if Mini Web Server used as RS485/IP converter

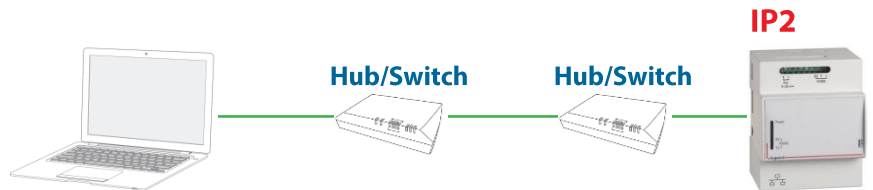

10.2 WAN/Internet Public network

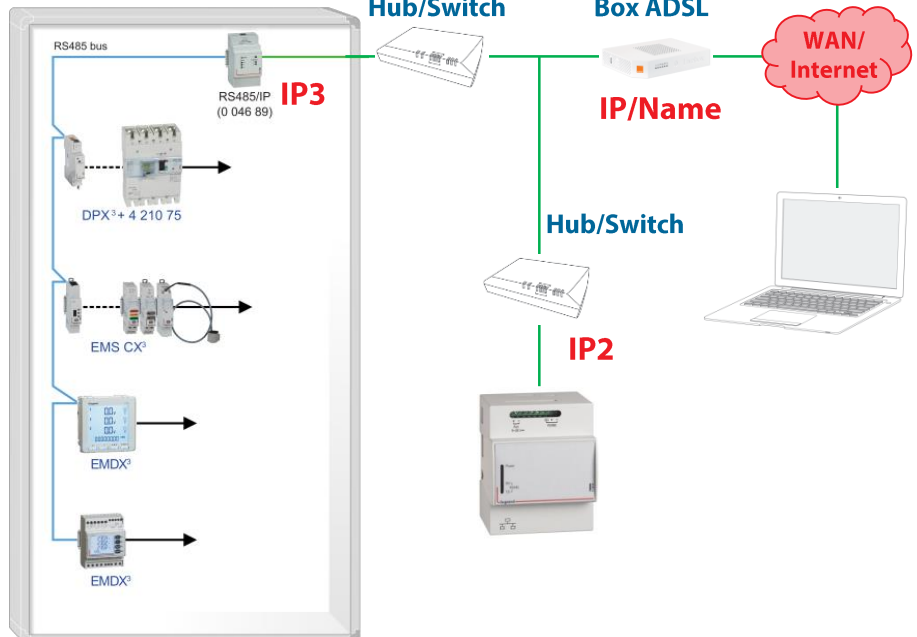

Fixed* IP Box: the IP address remains the same

⇒ Access by IP address (Fixed **IP** paying according to the operators)

Dynamic* IP Box : the address may change

⇒ Access by **Name** (possibility of creating a dynamic DNS account – Example www.dyndns.org).

- User: access by the **public address of the Box (IP/Name, Internet)**
- Web Server: always has a fixed private address (**IP2, Intranet**)

⇒ It is necessary to achieve the association web server/Box*

* More information from the ADSL operator

10.2.1 Ports

- Web Server to Gateway:
 - Port 502, Modbus TCP

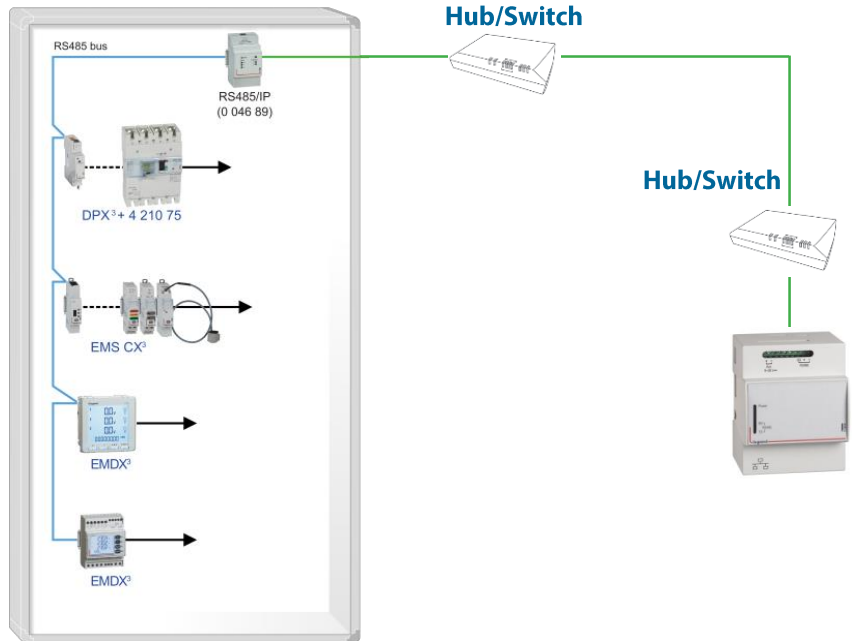

- Users to Web Server:
 - Port 80, HTTP (<http://IP2> by web browser)
 - Port 443, HTTPS (<https://IP2> by web browser)
 - Ports 20 and 21, FTP (<ftp://IP2> by web browser or in "My Computer")

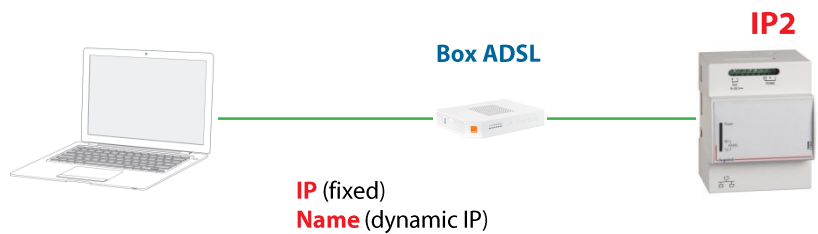

11. FAQ

11.1 Access problems

If typing the PIN and PUK codes, Web Server's home page is not displayed correctly (continuous refresh of the page), you have to do the following operations :

- delete the cookies
- delete the internet temporary files
- delete the cache
- delete the chronology

11.2 Telegram problems

If the "Test" function in the Telegram page does not work correctly, you have to check:

- the correct opening of the communication port 443 (*see § 10.1.1*)
- the correct configuration of the DNS of the Mini Web server in the "Network settings" page (*see § 7.7.1*)

11.3 E-mails sending test problems

If the "Test" function in the e-mails sender configuration page (page "Email" in the "Email and notification" menu) does not work correctly, you have to check:

- the correct opening of the communication port configured in the menu
- the correct configuration of the DNS of the Mini Web server in the "Network settings" page (*see § 7.7.1*)
- Options of your e-mail account related to access by deemed less secure applications



**World Headquarters and
International Department
87045 LIMOGES CEDEX FRANCE**

☎ : 33 5 55 06 87 87

Fax : 33 5 55 06 74 55

www.legrandelectric.com