

CONTENT	PAGE
■ 1. Use	2
■ 2. Range	2
■ 3. Technical features	2
3.1 Electrical features	2
3.2 Climatic features	2
3.3 Mechanical features	2
■ 4. Dimensions	2
■ 5. Connection	2
■ 6. Removal	2
■ 7. Installation	3
7.1 Sensor positioning	3
7.2 Recommended light exposure	3
■ 8. Operation	3
■ 9. Settings	4
9.1 Detection parameters	4
9.2 Lighting parameters	4
9.3 Other parameters	4
9.4 Modifying the parameters using the configuration tools	4
■ 10. Performance	5
10.1 PIR Performance - Motion detection	5
10.2 PIR Performance - Presence detection	5
■ 11. Standards and approvals	5
■ 12. Maintenance	5
■ 13. Communication objects	5
13.1 List of objects	5
13.2 General parameters	6
13.2.1 Main function - Master: Light level only	6
13.2.2 Main function - Master: Detection only	10
13.2.3 Main function - Master: Light level & Detection	12
13.2.4 Slave: Detection only	20
13.3 Load	21
13.3.1 Use dimming load	21
13.3.2 Use expert parameters	22
13.3.3 Standby time base (function only available in Master mode: detection and Master: Light level & Detection)	23
13.3.4 Use second load	25
13.4 Light level config	26
13.4.1 Use external daylight cell	26
13.5 Detection config	28
13.5.1 Send Condition	29
13.6 Auxiliary output	30
13.6.1 None	30
13.6.2 Switching	30
13.6.3 Scaled values	31
13.6.4 HVAC Mode	32
13.6.5 Scene	33
13.6.6 2 bytes value	34
13.7 Advanced	35
13.7.1 Sensitivity (only available for Master: Detection Only, Master: Light level & Detection and Slave: Detection Only modes)	35
13.7.2 System detection (only available for Master: Detection Only, Master: Light level & Detection and Slave: Detection Only modes)	35
13.7.3 Additional object for expert mode	36
13.8 Virtual Keycard	37
13.8.1 Use Virtual Keycard	37
13.8.2 Virtual keycard function operating diagram	41
13.9 Commissioning Tool	42
13.10 Pushbutton	43
13.10.1 Pushbutton function	43
■ 14. Application's examples	46
14.1 Mode Auto ON/OFF – Load ON/OFF	46
14.2 Mode Auto ON/OFF – Dimming load	46
14.3 Mode Manual ON/Auto OFF – Load ON/OFF	46
14.4 Mode Manual ON/Auto OFF – Dimming load	47
14.5 Master/Slave detection	47

1. USE

The KNX wiring devices sensors are passive infrared devices (PIR) suitable to detect motion and measure the daylight level. They can be installed directly on wiring devices boxes according to the specific wiring devices series. They are suitable for indoor passage areas like corridors, bathrooms, technical rooms...







Through its application program it is possible to configure all the working parameters such as daylight threshold, time delay, operating modes, technology sensibility... and it is possible to configure the following functions:

- Switching/dimming: automatically or manually if associated with a control device
- Define a minimum/maximum dimming level
- Customize the dimming pace
- Trigger scenarios based on: presence/absence
- Work in master/slave configuration
- Define a daylight level to be maintained until presence is detected
- Manage more than one output with the same commands

All the KNX wiring devices sensor already embed a push button

All the working parameters are configurable via ETS but is also possible to modify the main operating parameters (daylight threshold, time delay, technology sensibility...) via commissioning tool ref. 088230/ BMSO4001.

2. RANGE

Description	Catalogue number
 KNX-Livinglight PIR wiring device sensor, anthracite	L4658KNX
 KNX-Livinglight PIR wiring device sensor, white	N4658KNX
 KNX-Livinglight PIR wiring device sensor, tech	NT4658KNX
 KNX-Axolute PIR wiring device sensor, anthracite	HC4658KNX
 KNX-Axolute PIR wiring device sensor, white	HS4658KNX
 KNX-Axolute PIR wiring device sensor, tech	HD4658KNX

3. TECHNICAL FEATURES

3.1 Electrical features

- KNX BUS power supply: 29 V_{DC}
- KNX BUS absorption: 16 mA (PIR)
- KNX connector (red/black): terminal capacity 4x (Ø 0,6 à 0,8 mm)

3.2 Climatic features

- Environmental operating temperature : -5°C to +45°C
- Storage temperature : -25°C to +70°C

3.3 Mechanical features

- Impact resistance: IK04
- Penetration by solid and liquid matter: IP20

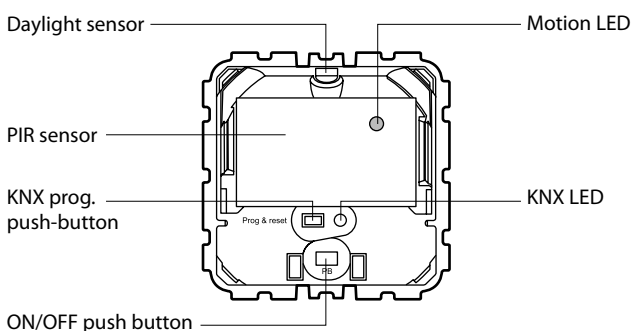

4. DIMENSIONS

Livinglight

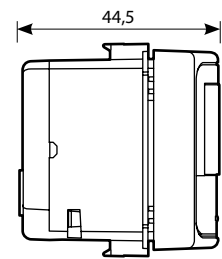
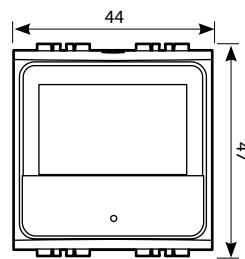

Axolute

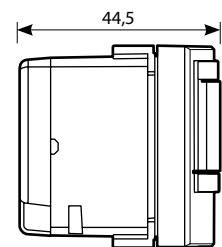
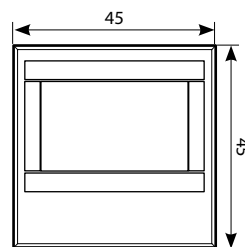

5. CONNECTION

KNX red/black connector

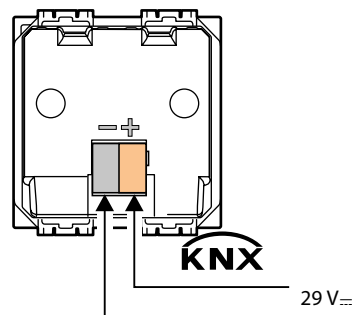
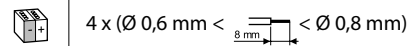

6. REMOVAL

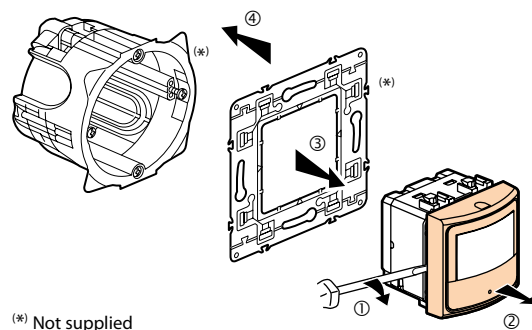

(*) Not supplied

7. INSTALLATION

7.1 Sensor positioning

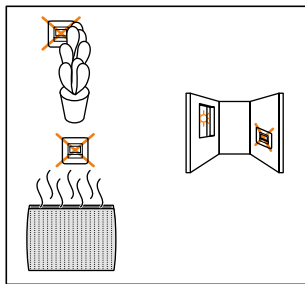
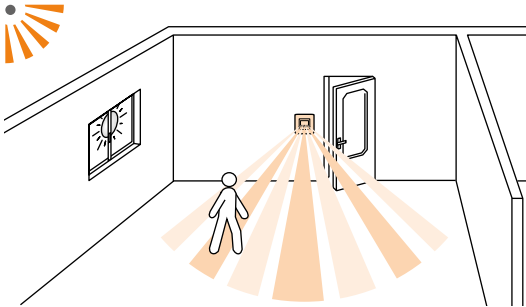

7.2 Recommended light exposure

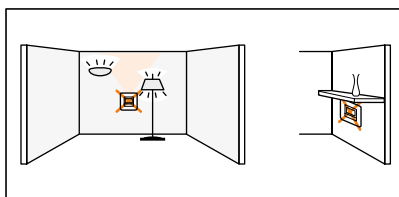
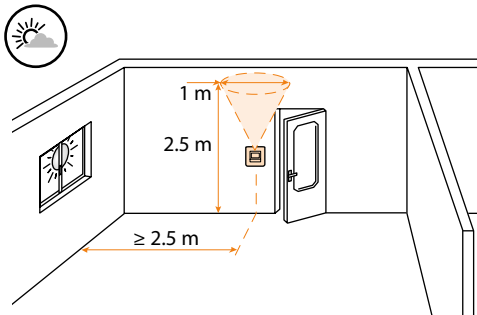

8. OPERATION

The KNX sensors offer many functions, on follows a summary of them (see section "Communication objects" for details):

Functions:

Automatic or manual switching/dimming with constant daylight regulation

Possibility to control a second lighting level as a % of the main one maintaining a positive or negative offset.

Coupling several detectors: It is possible to set the sensors in Master or slave configuration in order to cover a larger area with a synchronized presence detection.

Sending message on presence / absence: Upon presence/absence can be sent an additional command: switching command, values, scene...

Warning of end detection: After the time delay, the light can be configured to assume a standby level (for a standby time interval) as to warn of the imminent extinction.

Presence and brightness level information is available on the bus: Values available for a supervision system.

Daylight setpoint and time delay modifiable by bus: Values which can be modified by a supervision system.

Partial on/Group off Mode:

It is possible to turn ON just a subset of lights but at the end of time delay turn OFF all the lights. Classroom example: Room Lighting: automatic switch ON; Board Lighting: manual control. On end detection, total extinction, room and board.

Virtual Keycard: Especially thought for hotels, the combination of presence sensors, door contacts and other informations (e.g. other detectors, push buttons...) allow determining the presence in the room and empower some circuits in the room, launch scenarios or any other kind of logics.

The functions is triggered by the "door contact" event which launch the so called "Virtual keycard time delay", a time offset in which the sensor tries to understand if the room is occupied or not on the basis of some informations: sensor detection, window contact events, push buttons event. Once the result of the function is "occupied" it remains until there is another "Door contact event" which trigger another "Virtual keycard time delay" to understand the room status and eventually turn OFF the lights, launch an absence scenario or launch any other logic related to vacancy event.

The product global configuration is made via ETS (version 3 or upper) and it is also possible to modify the main operating parameters via commissioning tool 088230/BMSO4001 (see following section for further details)

9. SETTINGS

Following the main operating parameters modifiable via commissioning tool 088230/BMSO4001.

9.1 Detection parameters

Sensor parameter		Default value	Possible values	Configuration tools 088230/ BMSO4001
Time delay		15 min	5 s - 17 H 59 min 59 s	✓
Sensitivity		PIR (Very high)	Low, Medium, High, Very high	✓
Detection system	Initial	PIR	No modifiable	✓
	Maintain	PIR	No modifiable	✓

- Time delay:** It is the time interval between the moment in which a sensor does not detect motion/presence and the deactivation of the load. The time period re-starts whenever the sensor detects motion/presence
- Sensitivity:** It is the detection technology sensitivity.

Detection system:

It is the set of technologies used for detection

Initial detection: it is the set of technologies used for the first detection

Maintain: it is the set of technologies used after the first detection

9.2 Lighting parameters

Sensor parameter		Default value	Possible values	Configuration tools 088230/ BMSO4001
Daylight setpoint		300 lux	5 - 1275 lux	✓

- Daylight setpoint:** it is the lighting level under which the sensor enables the load and over which the sensor disables the load.
- Eye function:** Value 0 (eye on configuration tool 088230/BMSO4001) this function allows to record in the sensor the actual general lighting level and use it as daylight setpoint.

9.3 Other parameters

Sensor parameter		Default value	Possible values	Configuration tools 088230/ BMSO4001
Output	Standby delay (main load)	Disabled	Disabled/infinite/ 1 s - 1 h	✓
	Standby level (main load)	10 %	1 - 100 %	✓

Standby level: it is the level, expressed in % of the daylight setpoint, at which the load is kept turned ON during the standby delay.

Standby delay: it is the time interval in which the load is kept turned ON at the standby level. It begins as soon as the sensor does not detect motion/presence

9. SETTINGS (continued)

9.4 Modifying the parameters using the configuration tools

• 0 882 40: Configuration gateway and Legrand Close Up application. The Close Up application is available on the Apple Store and the Play Store



App Store



Google Play



The detector functions are controlled by a number of parameters which can be changed or programmed by an infrared configurator. In combination with configuration tool 0 882 40, the Legrand Close Up smartphone app can be used to view and modify all the detector parameters with online help. Point the infrared configuration tool at the detector and send the necessary programming commands to the unit as indicated in the table below.

For more information about setting parameters, refer to the data sheet for the configuration gateway Cat. No. 0 882 40.

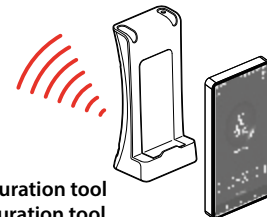
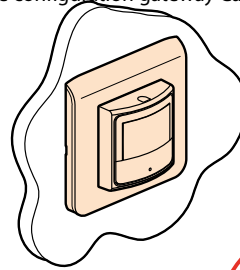

- 0 882 35: Simplified configuration tool
- 0 882 30: Advanced configuration tool

When the sensor receives an IR command via a configuration tool, it emits a beep acknowledging the modification. For more information about setting parameters, refer to the data sheet for the configuration tool Cat. No. 0 882 30 and the lighting management sensor guide.

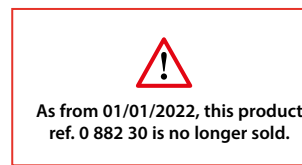

• 088230/BMSO4001: Advanced configuration tool
When the sensor receives an IR command via a configuration tool, the LED blinks.

- Restore to factory settings:

- 1st press: Short press on PROG, the LED flashes slowly.
- 2nd press: Hold down PROG for 10 seconds until the LED flashes quickly.

10. PERFORMANCE

10.1 PIR Performance - Motion detection

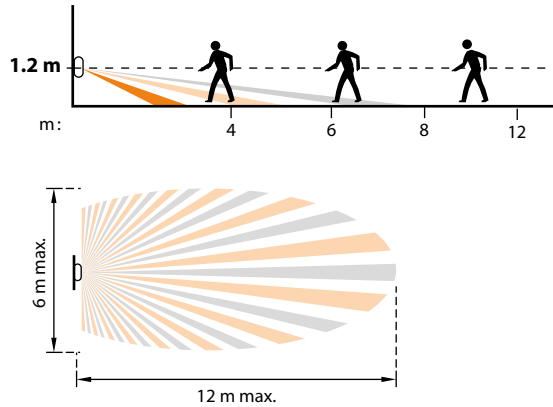

Sensitivity	m
Low (25%)	7
Medium (50%)	8
High (75%)	10
Very high (100%)	12

10.2 PIR Performance - Presence detection

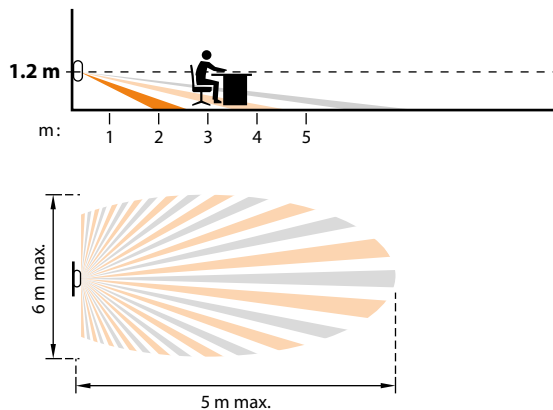

Sensitivity	m
Low (25%)	1
Medium (50%)	2
High (75%)	4
Very high (100%)	5

11. STANDARDS AND APPROVALS

- Complies with standard IEC 60 669.2.1
- Marking: KNX, CE

12. MAINTENANCE

Clean the surface with a cloth.
Do not use acetone, tar-removing cleaning agents or trichloroethylene.

Caution:

Always test before using other special cleaning products.

13. COMMUNICATION OBJECTS

13.1 List of objects

Here are listed the communication objects active by default settings.

No.	Object name	Function	Size	Flags
1	Switching	Switching	1.001 DP_On/Off	CT

Switching telegrams are sent via the group address linked to this object

2	Switching Status	Switching Status	1.001 DP_On/Off	CWTU
---	------------------	------------------	-----------------	------

Switching statuses are received via the group address linked to this object.

*If switching statuses are received but the Switching object has not been sent by the sensor, the regulation is stopped.

5	In Occupancy	In Occupancy	1.002 DP_BooI	CW
---	--------------	--------------	---------------	----

In Occupancy statuses are received via the group address linked to this object.

It will be used especially for connecting slave sensor and increase a detection zone (13.5 Master/slave detection).

True: The sensor reacts as if there is an internal detection

False: No reaction

6	Occupancy status	Occupancy status	1.002 DP_BooI	CRT
---	------------------	------------------	---------------	-----

Out Occupancy statuses are sent via the group address linked to this object

True: When motion is detected

False: After vacancy time delay, or occupancy if vacancy is not used

8	Out Lux	Out Lux	9.004 DP_Lux	CRT
---	---------	---------	--------------	-----

Out Lux values are sent via the group address linked to this object.

Send operations can be set in ETS (Cyclical, on change, on request).

16	Switching group off	Switching group off	1.001 DP_On/Off	CRT
----	---------------------	---------------------	-----------------	-----

Switching group off statuses are sent via the group address linked to this object.

On vacancy is sent an OFF via the group address linked to this object.

20	Out occupancy	Out occupancy	1.002 DP_BooI	CT
----	---------------	---------------	---------------	----

Out synchro Master-> Slave statuses are sent via the group address linked to this object

True: The maintain status is sent to the slave

False: The initial status is sent to the slave

21	Enable	Enable	1.003 DP_Enable	CRW
----	--------	--------	-----------------	-----

Enable telegrams are received via the group address linked to this object.

They are used to lock (disable) or unlock (enable) the corresponding input.

13. COMMUNICATION OBJECTS (continued)

13.2 General parameters

13.2.1 Main function - Master: Light level only

Parameters	Settings
Main function	Master: Light level only Master: Detection only Master: Light level & detection Slave: Detection only

Only load and light level can be configured in the associated page, and regulation is active

13.2.1.1 Mode

• Auto on/Auto off mode

Comes on automatically: - At the detection of a presence if there is an insufficient natural level of light. Turns off automatically: - If no presence is detected and at the end of the time delay set. - Or if there is a sufficient natural level of light (activated setting). Any new detection causes an automatic switch on if there is insufficient light.

• Walkthrough

- If there is no presence detected in the 3 minutes following an initial detection, the product will cut off after 3 minutes.
 - If a new presence is detected in the 3 minutes following the initial detection, the device will cut off at the end of the time delay set.
 Manual on/Auto off mode: Comes on via a manual switch, automatic switch off: - Where no presence is detected and at the end of the time delay set. Following switch-off any new detection within a 30 second period will cause the device to be switched on automatically. After 30 seconds the device is switched on via a manual switch.

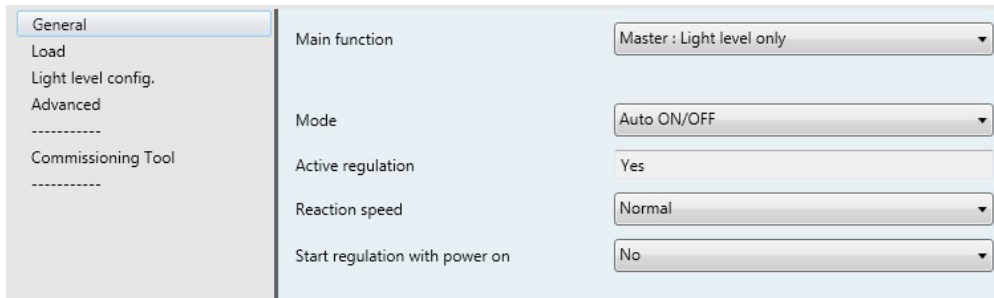

Parameters	Settings
Reaction speed	Very Low Low Normal Fast Very Fast

This parameter determines the speed reaction of the régulation in dimming or switching

Start regulation with power on	Yes No
--------------------------------	------------------

This parameter determines if regulation is started with power on

System behaviour:

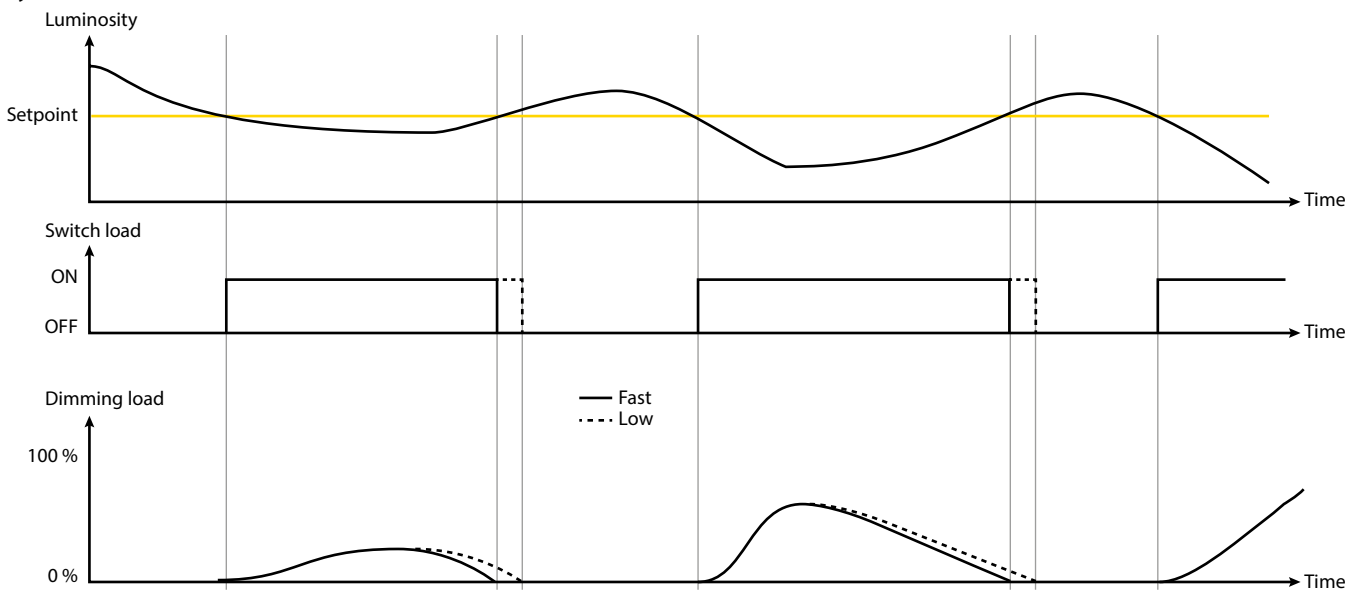

13. COMMUNICATION OBJECTS (continued)

13.2 General parameters (continued)

13.2.1 Main function - Master: Light level only (continued)

13.2.1.2 Mode: Manual ON/Auto OFF

General	Main function	Master : Light level only
Load	Mode	Manual ON/Auto OFF
Light level config.	Active regulation	Yes
Advanced	Reaction speed	Normal
-----	Action on "Synchro regulation" object on start	ON + Start regulation
Commissioning Tool	Action on "Synchro regulation" object on stop	Stop regulation + OFF
-----	Use scene	No

No.	Object name	Function	Size	Flags
13	Synchro regulation	Synchro regulation	1.010 DP_Start/stop	CW

In Lux values are received via the group address linked to this object.
 Start and stop can be configured in ETS.
 Message start/stop régulation is received to this object.

14	Regulation status	Regulation status	1.010 DP_Start/stop	CRT
----	-------------------	-------------------	---------------------	-----

Regulation statuses are sent via the group address linked to this object

System behaviour:

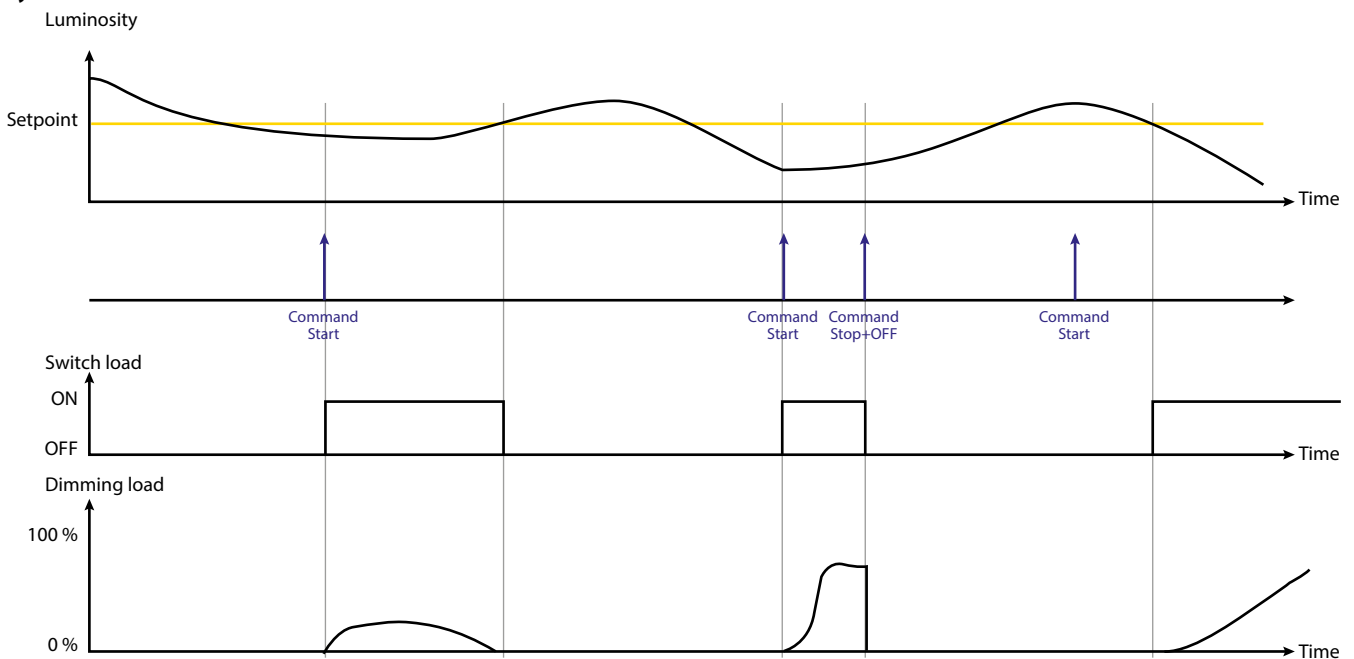

13. COMMUNICATION OBJECTS (continued)

■ **13.2 General parameters (continued)**

13.2.1 Main function - Master: Light level only (continued)

13.2.1.2 Mode: Manual ON/Auto OFF (continued)

Parameters	Settings
Action on "Synchro regulation" object on start	Start regulation ON + Start regulation Stop regulation Stop regulation + ON Stop regulation + OFF No reaction
<p>This parameter determines the regulation reaction when Start received. <i>Start regulation:</i> Regulation is run with no action on load <i>ON + Start regulation:</i> Regulation is run with ON action on load <i>Stop regulation:</i> Regulation is stopped with no action on load <i>Stop regulation + ON:</i> Regulation is stopped with ON action on load <i>Stop regulation + OFF:</i> Regulation is stopped with OFF action on load <i>No reaction:</i> No reaction</p>	
Action on "Synchro regulation" object on stop	Start regulation ON + Start regulation Stop regulation Stop regulation + ON Stop regulation + OFF No reaction
<p>This parameter determines the regulation reaction when Stop received. <i>Start regulation:</i> Regulation is run with no action on load <i>ON + Start regulation:</i> Regulation is run with ON action on load <i>Stop regulation:</i> Regulation is stopped with no action on load <i>Stop regulation + ON:</i> Regulation is stopped with ON action on load <i>Stop regulation + OFF:</i> Regulation is stopped with OFF action on load <i>No reaction:</i> No reaction</p>	
Use scene	No Yes
<p>No: In scene regulation cannot be used, no accessible communication objects.</p>	

• Use scene → Yes

Use scene	Yes
Scene A number (0: not used)	0
Scene A action	No reaction
Scene B number (0: not used)	0
Scene B action	No reaction
Scene C number (0: not used)	0
Scene C action	No reaction
Scene D number (0: not used)	0
Scene D action	No reaction
Scene E number (0: not used)	0
Scene E action	No reaction

13. COMMUNICATION OBJECTS (continued)**■ 13.2 General parameters (continued)****13.2.1 Main function - Master: Light level only (continued)****13.2.1.2 Mode: Manual ON/Auto OFF (continued)**

- **Use scene** → **Yes (continued)**

When use scene is yes: this object communication is available.

No.	Object name	Function	Size	Flags
12	In_scene_ regulation	In_scene_ regulation	17.001 DP_Scene_ number	CW

8-bit auxiliary telegrams are received via the group address linked to this object. On scene telegram you can start/stop régulation with on/off (mode manuel On/Auto Off).

Parameters	Settings
Scene A to E number	0-64
This parameter determines which scene (1..64) is to be recalled. If value "0" is set, no scene will be recalled	
Scene A to E action	Start regulation ON + Start regulation Stop regulation Stop regulation + ON Stop regulation + OFF No reaction

This parameter determines the regulation reaction when scene number is received.

Start regulation: Regulation is run with no action on load

ON + Start regulation: Regulation is run with ON action on load

Stop regulation: Regulation is stopped with no action on load

Stop regulation + ON: Regulation is stopped with ON action on load

Stop regulation + OFF: Regulation is stopped with OFF action on load

No reaction: No reaction

13. COMMUNICATION OBJECTS (continued)

13.2 General parameters (continued)

13.2.2 Main function - Master: Detection only

Parameters	Settings
Main function	Master: Light level only Master: Detection only Master: Light level & detection Slave: Detection only

Load, detection, early warning, AuxOutput and Advanced config can be configured in the various associated pages, and regulation is not active.

13.2.2.1 Mode: Auto ON/OFF

General

Load

Detection config.

Auxiliary output

Advanced

Virtual keycard

Commissioning Tool

Main function Master : Detection only ▼

Mode Auto ON/OFF ▼

Active regulation No

Parameters	Settings
Active regulation	Yes No

No: No regulation possible

System behaviour:

Time delay

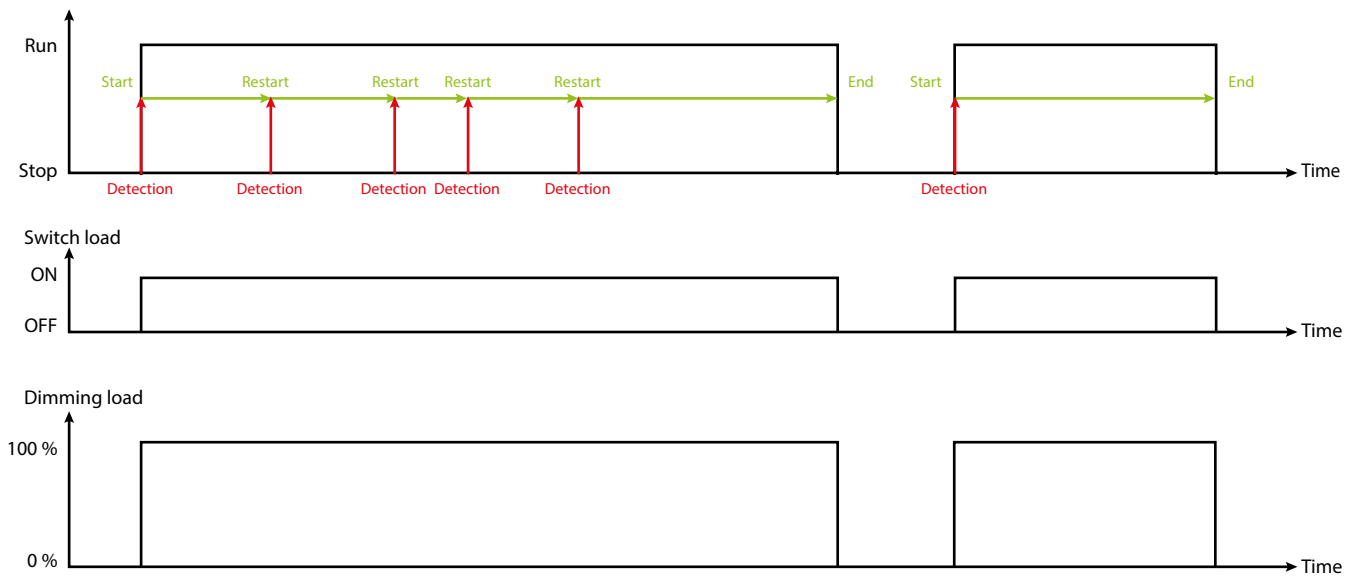

13. COMMUNICATION OBJECTS (continued)

13.2 General parameters (continued)

13.2.2 Main function - Master: Detection only (continued)

13.2.2.2 Mode: Manual ON/Auto OFF

General	Main function	Master : Detection only
Load	Mode	Manual ON/Auto OFF
Detection config.	Active regulation	No
Auxiliary output		
Advanced		

Virtual keycard		
Commissioning Tool		

No.	Object name	Function	Size	Flags
13	Synchro on/off	Synchro on/off	1.010 DP_Start/stop	CW

Synchro on/off statuses are received via the group address linked to this object.

Parameters	Settings
Active regulation	Yes No

No: No regulation possible

System behaviour:

Time delay

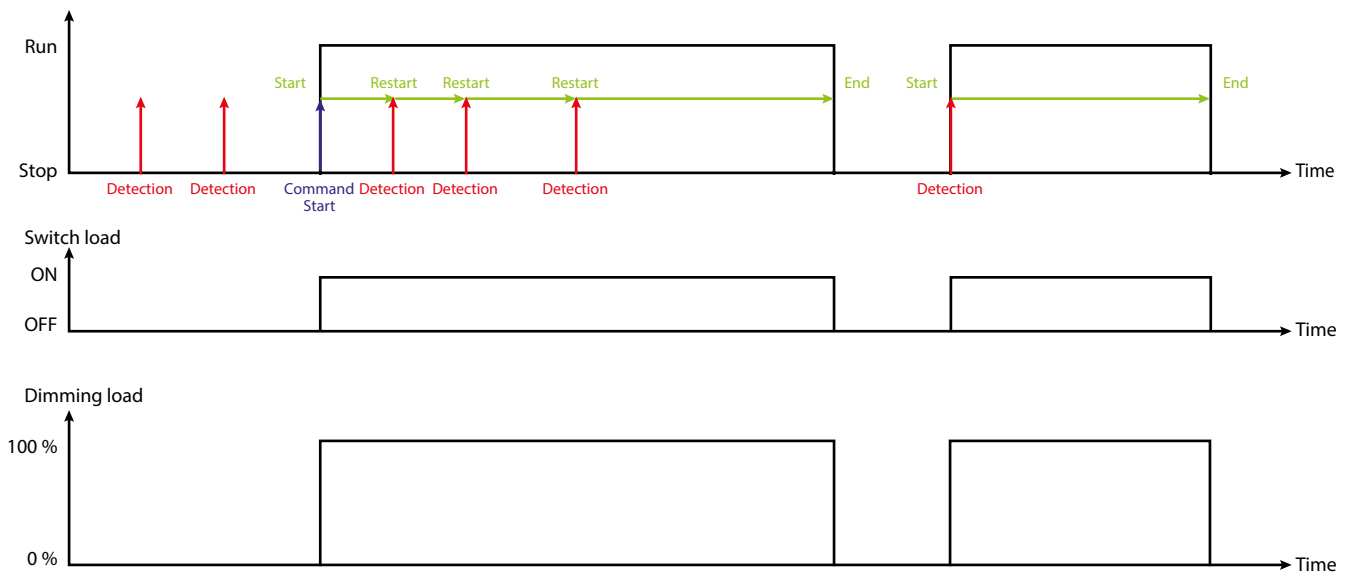

13. COMMUNICATION OBJECTS (continued)

13.2 General parameters (continued)

13.2.3 Main function - Master: Light level & Detection

Parameters	Settings
Main function	Master: Light level only Master: Detection only Master: Light level & detection Slave: Detection only

Load, light level, detection, early warning, AuxOutput and Advanced config can be configured in the various associated pages.

13.2.3.1 Mode: Auto ON/OFF

The system runs automatically.

Parameters	Settings
Active regulation	Yes No

No: No regulation possible

Yes: The cell in the sensor will switch ON/OFF or dim its associated loads according to variations in the natural light

System behaviour:

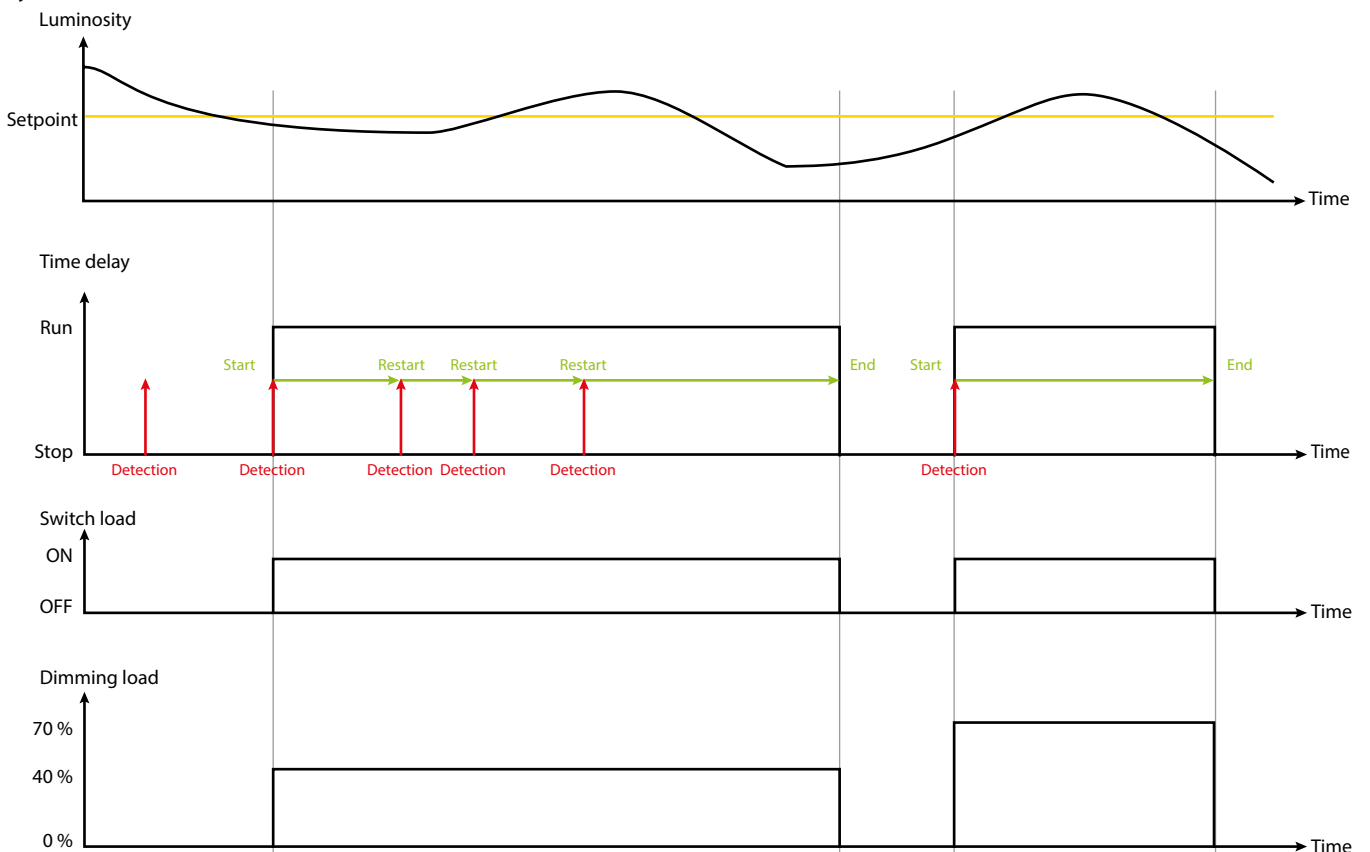

13. COMMUNICATION OBJECTS (continued)

■ **13.2 General parameters (continued)**

13.2.3 Main function - Master: Light level & Detection (continued)

13.2.3.1 Mode: Auto ON/OFF(continued)

General	Main function	Master : Light level & detection
Load		
Light level config.		
Detection config.	Mode	Auto ON/OFF
Auxiliary output		
Advanced	Active regulation	Yes

Virtual keycard	Reaction speed	Normal
Commissioning Tool		

Parameters	Settings
Active regulation	Yes No

No: No regulation possible

Yes: The cell in the sensor will switch ON/OFF or dim its associated loads according to variations in the natural light

Reaction speed	Very Low Low Normal Fast Very Fast
-----------------------	---

This parameter determines the speed reaction of the regulation in dimming or switching

When active régulation is yes: this object communication is available.

No.	Object name	Function	Size	Flags
10	In_Detection_enable	In_Detection_enable	1.003 DP_Enable	CRW

In detection enable statuses are received via the group address linked to this object.

Enable: The sensor is in Light level & detection mode

Disable: The sensor is in light level only mode

Used to enable/disable the DETECTION ONLY, by a control schedule for example.

13. COMMUNICATION OBJECTS (continued)

■ **13.2 General parameters (continued)**

13.2.3 Main function - Master: Light level & Detection (continued)

13.2.3.1 Mode: Auto ON/OFF(continued)

System behaviour:

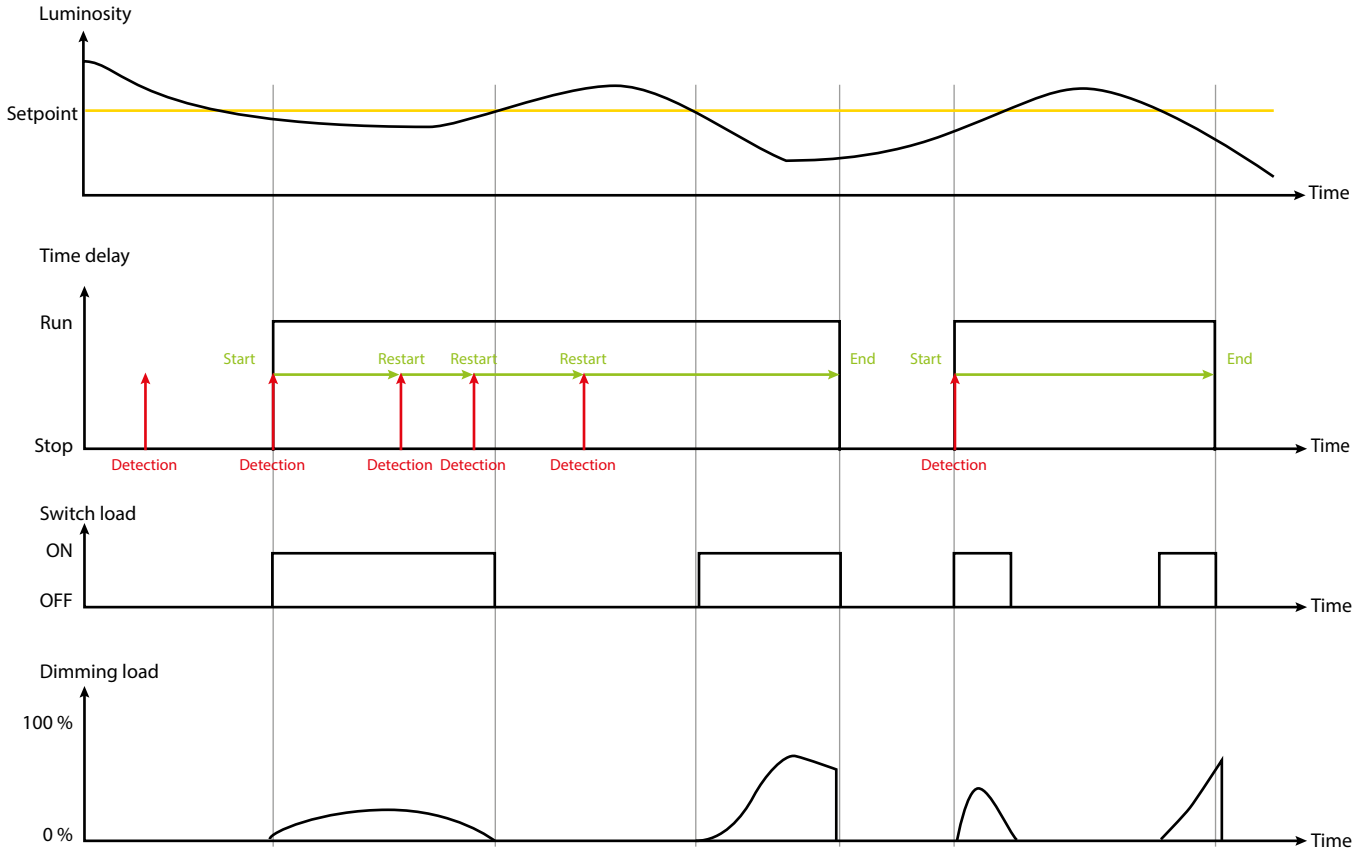

13.2.3.2 Mode: AUTO Walkthrough

<ul style="list-style-type: none"> General Load Light level config. Detection config. Auxiliary output Advanced ----- Virtual keycard Commissioning Tool ----- 	<p>Main function: Master : Light level & detection</p> <p>Mode: Auto Walkthrough</p> <p>Active regulation: Yes</p> <p>Reaction speed: Normal</p>
--	--

Parameters	Settings
Active regulation	Yes No

No: No regulation possible

Yes: The cell in the sensor will switch ON/OFF or dim its associated loads according to variations in the natural light

Reaction speed	Very Low Low Normal Fast Very Fast
-----------------------	---

This parameter determines the speed reaction of the regulation in dimming or switching

13. COMMUNICATION OBJECTS (continued)

■ **13.2 General parameters (continued)**

13.2.3 Main function - Master: Light level & Detection (continued)

13.2.3.3 Mode: Manual On/Auto Off

The system runs with manual operation.

General	Main function	Master : Light level & detection
Load	Mode	Manual ON/Auto OFF
Light level config.	Active regulation	No
Detection config.		
Auxiliary output		
Advanced		

Virtual keycard		
Commissioning Tool		

No.	Object name	Function	Size	Flags
13	Synchro on/off	Synchro on/off	1.010 DP_Start/stop	CW

Synchro on/off statuses are received via the group address linked to this object

Parameters	Settings
Active regulation	Yes No

No: No regulation possible

Yes: The cell in the sensor will switch ON/OFF or dim its associated loads according to variations in the natural light

System behaviour:

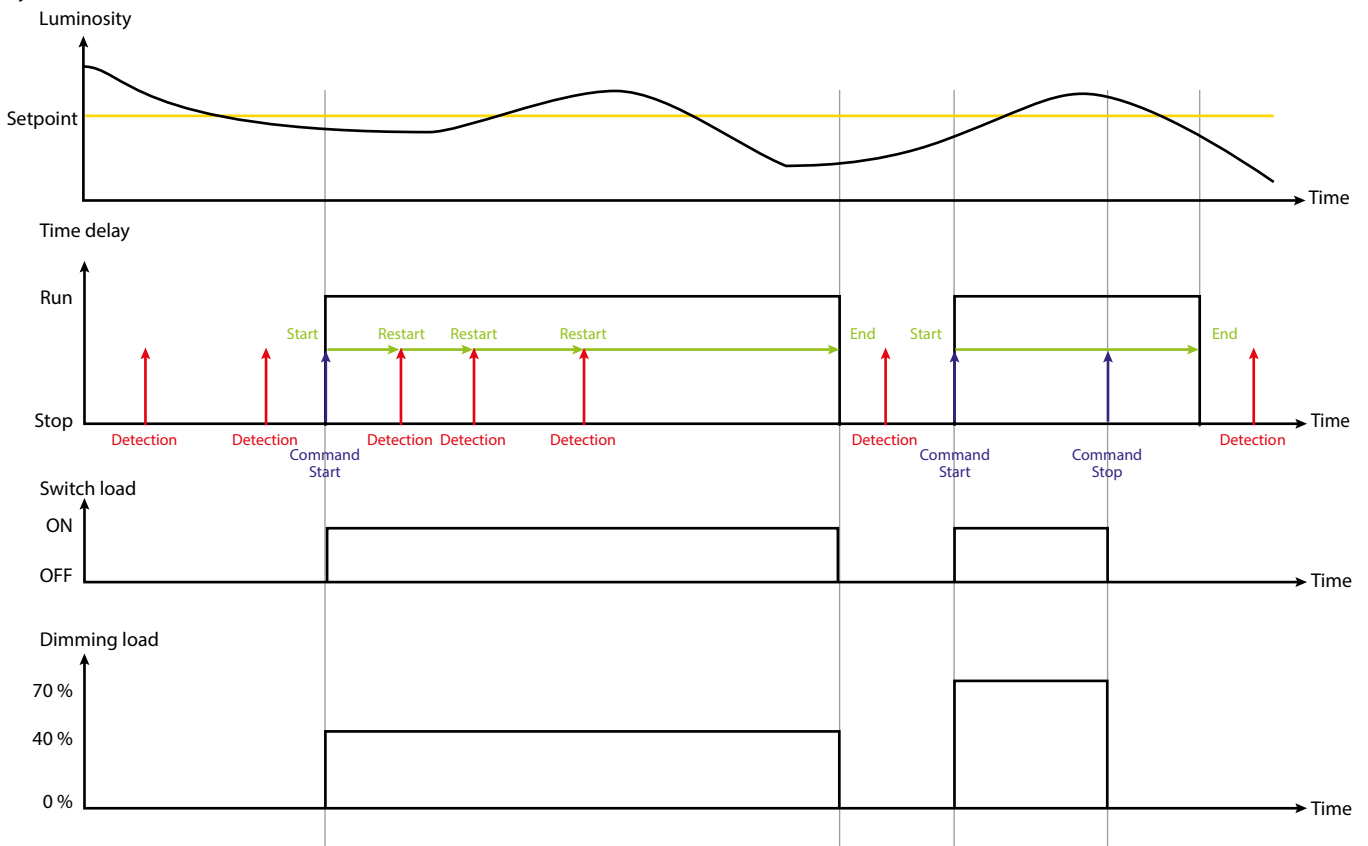

13. COMMUNICATION OBJECTS (continued)

■ **13.2 General parameters (continued)**

13.2.3 Main function - Master: Light level & Detection (continued)

13.2.3.3 Mode: Manual On/Auto Off (continued)

General	Main function	Master : Light level & detection
Load	Mode	Manual ON/Auto OFF
Light level config.	Active regulation	Yes
Detection config.	Reaction speed	Normal
Auxiliary output	Action on "Synchro regulation" object on start	ON + Start regulation
Advanced	Action on "Synchro regulation" object on stop	Stop regulation + OFF
-----	Use scene	No
Virtual keycard		
Commissioning Tool		

Parameters	Settings
Active regulation	Yes No

No: No regulation possible

Yes: The cell in the sensor will switch ON/OFF or dim its associated loads according to variations in the natural light

When active régulation is yes: this object communication is available.

No.	Object name	Function	Size	Flags
13	Synchro regulation	Synchro regulation	1.010 DP_Start/stop	CW

In Lux statuses are received via the group address linked to this object.
Start and stop can be configured in ETS.

No.	Regulation status	Regulation status	1.010 DP_Start/stop	CRT
14	Regulation status	Regulation status	1.010 DP_Start/stop	CRT

Regulation statuses are sent via the group address linked to this object

13. COMMUNICATION OBJECTS (continued)

■ **13.2 General parameters (continued)**

13.2.3 Main function - Master: Light level & Detection (continued)

13.2.3.3 Mode: Manual On/Auto Off (continued)

System behaviour:

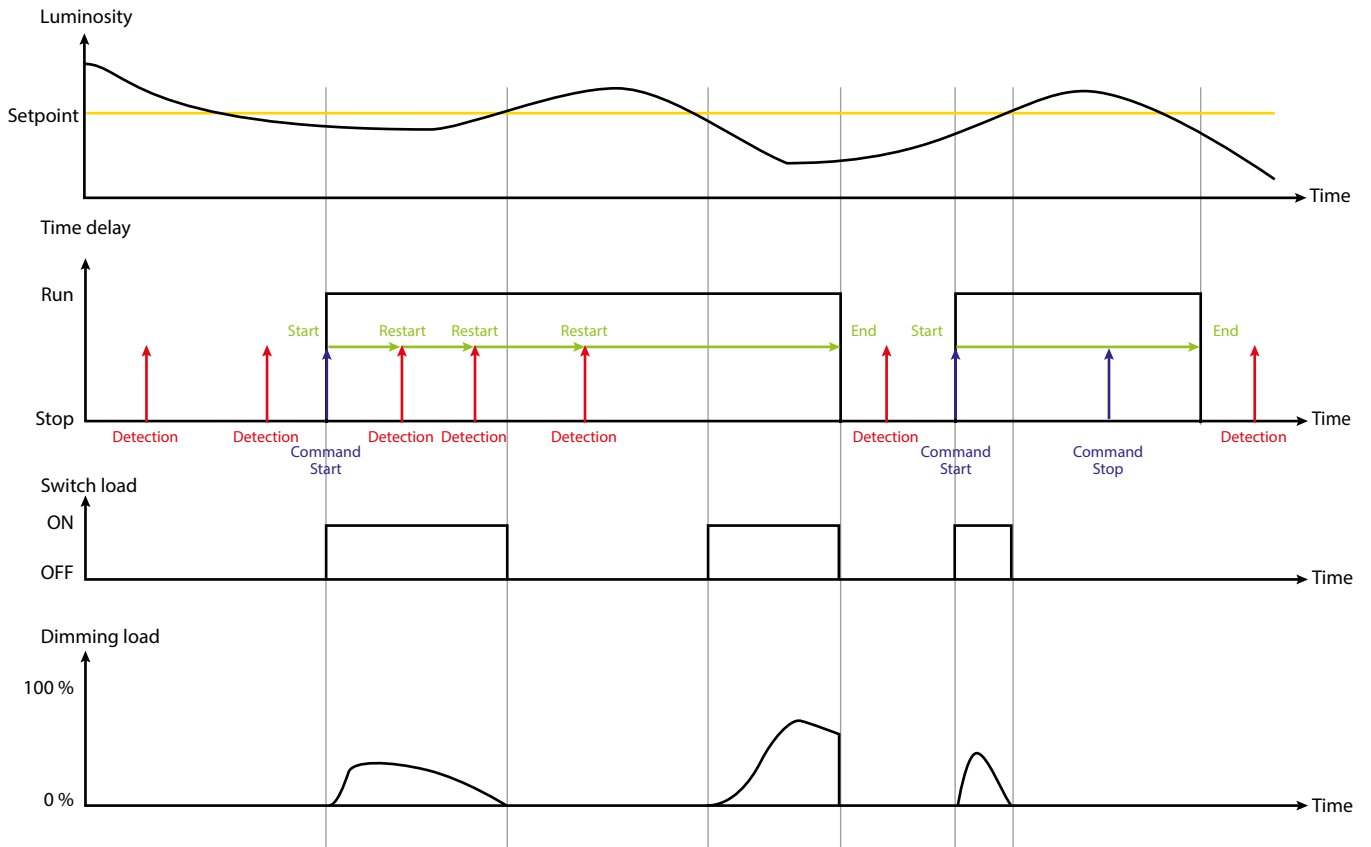

13. COMMUNICATION OBJECTS (continued)**■ 13.2 General parameters (continued)****13.2.3 Main function - Master: Light level & Detection (continued)****13.2.3.3 Mode: Manual On/Auto Off (continued)**

Parameters	Settings
Reaction speed	Very Low Low Normal Fast Very Fast

This parameter determines the speed reaction of the regulation in dimming or switching

Action on "Synchro regulation" object on start	Start regulation ON + Start regulation Stop regulation Stop regulation + ON Stop regulation + OFF No reaction
--	--

This parameter determines the regulation reaction when Start received.

Start regulation: Regulation is run with no action on load

ON + Start regulation: Regulation is run with ON action on load

Stop regulation: Regulation is stopped with no action on load

Stop regulation + ON: Regulation is stopped with ON action on load

Stop regulation + OFF: Regulation is stopped with OFF action on load

No reaction: No reaction

Action on "Synchro regulation" object on stop	Start regulation ON + Start regulation Stop regulation Stop regulation + ON Stop regulation + OFF No reaction
---	--

This parameter determines the regulation reaction when Stop received.

Start regulation: Regulation is run with no action on load

ON + Start regulation: Regulation is run with ON action on load

Stop regulation: Regulation is stopped with no action on load

Stop regulation + ON: Regulation is stopped with ON action on load

Stop regulation + OFF: Regulation is stopped with OFF action on load

No reaction: No reaction

Use scene	No Yes
-----------	-----------

No: In scene regulation cannot be used, no accessible communication objects.

13. COMMUNICATION OBJECTS (continued)

■ **13.2 General parameters (continued)**

13.2.3 Main function - Master: Light level & Detection (continued)

13.2.3.3 Mode: Manual On/Auto Off (continued)

• Use scene → Yes

Use scene	Yes
Scene A number (0: not used)	0
Scene A action	No reaction
Scene B number (0: not used)	0
Scene B action	No reaction
Scene C number (0: not used)	0
Scene C action	No reaction
Scene D number (0: not used)	0
Scene D action	No reaction
Scene E number (0: not used)	0
Scene E action	No reaction

When use scene is yes: this object communication is available.

No.	Object name	Function	Size	Flags
12	In_scene_regulation	In_scene_regulation	17.001 DP_Scene_number	CW

8-bit auxiliary telegrams are received via the group address linked to this object

Parameters	Settings
Scene A to E number This parameter determines which scene (1..64) is to be recalled. If value "0" is set, no scene will be recalled	0-64
Scene A to E action	Start regulation ON + Start regulation Stop regulation Stop regulation + ON Stop regulation + OFF No reaction

This parameter determines the regulation reaction when scene number is received.

- Start regulation:* Regulation is run with no action on load
- ON + Start regulation:* Regulation is run with ON action on load
- Stop regulation:* Regulation is stopped with no action on load
- Stop regulation + ON:* Regulation is stopped with ON action on load
- Stop regulation + OFF:* Regulation is stopped with OFF action on load
- No reaction:* No reaction

13. COMMUNICATION OBJECTS (continued)

■ **13.2 General parameters (continued)**

13.2.4 Slave: Detection only

Parameters	Settings
Main function	Master: Light level only Master: Detection only Master: Light level & detection Slave: Detection only

You can configure the detection, Advance config in the different page associated, and regulation is not active. You can associate the sensors with the sensor master to extend the detection zone , see the configuration § 13.5.

13. COMMUNICATION OBJECTS (continued)

■ 13.3 Load

Page only available for Master: Light level Only, Master: Detection Only and Master: Light level & Detection modes.

No.	Object name	Function	Size	Flags
1	Switching	Switching	1.001 DP_On/Off	CT

Switching telegrams are sent via the group address linked to this object

2	Switching Status	Switching Status	1.001 DP_On/Off	CWTU
---	------------------	------------------	-----------------	------

Switching statuses are received via the group address linked to this object.

*If switching statuses are received but the Switching object has not been sent by the sensor, the regulation is stopped.

13.3.1 Use dimming load

Parameters	Settings
Use dimming load	Yes No

No: Level, level status and In_Sync_Dim cannot be used, no accessible communication objects

No.	Object name	Function	Size	Flags
3	Level	Level	5.001 DP Percentage	CT

Level telegrams are sent via the group address linked to this object

4	Level status	Level status	5.001 DP Percentage	CWTU
---	--------------	--------------	---------------------	------

Level statuses are received via the group address linked to this object.

*If Level statuses are received but the Level object has not been sent by the sensor, the regulation is stopped.

9	In Synchro dimming	In Synchro dimming	3.007 DP_dimming control	CW
---	--------------------	--------------------	--------------------------	----

In override dimming values are received via the group address linked to this object. Any value received on this object is considered to be an override.

13. COMMUNICATION OBJECTS (continued)

■ **13.3 Load (continued)**

13.3.2 Use expert parameters

Parameters only available for Master Light level Only and Master Light level & Detection modes.

Parameters	Settings
Dimming expert configuration	Yes No

No: Use for the current load type

When dimming expert configuration is yes: this object communication is available.

No.	Object name	Function	Size	Flags
24	Syncro_MinimumLevel	Syncro_MinimumLevel	5.001 DP Percentage	CRW

Syncro_MinimumLevel values are received via the group address linked to this object

Parameters	Settings
Minimum level This parameter determines the minimum level of the actuator	0-100
Maximum level This parameter determines the maximum level of the actuator	0-100
Time from Off state to On (100%) state This parameter determines the time (in seconds) for the actuator to change from OFF to ON (0% to 100%)	1-60
Load curve This parameter determines the response curve of the actuator	Linear Type 1 (DALI) Custom Reserved Reserved

13. COMMUNICATION OBJECTS (continued)

■ **13.3 Load (continued)**

13.3.3 Standby time base (function only available in Master mode: detection and Master: Light level & Detection)

Parameters only available for Master Light level Only and Master Light level & Detection modes.

• **Standby configuration :**

You alert the user to the switch off the light: after the last detection (plus detection time delay) you can reduce the level of light.

Parameters	Settings
Standby time base	Disable Infinite Seconds Minutes

Disable: Standby is not active

Infinite: At the end of time delay the load decreases to standby level for an infinite time

Seconds: At the end of time delay the load decreases to standby level for the standby time in seconds

Minutes: At the end of time delay the load decreases to standby level for the standby time in minutes

General

Load

Light level config.

Detection config.

Auxiliary output

Advanced

Virtual keycard

Commissioning Tool

Use dimming load Yes ▾

Dimming expert configuration

Use expert parameters Yes ▾

Minimum level 10 ⬆️ ⬇️ ⬆️

Maximum level 100 ⬆️ ⬇️ ⬆️

Time from Off to On (100%) state 5 ⬆️ ⬇️ ⬆️

Load curve Linear ▾

Standby configuration

Standby time base Minutes ▾

Delay 1 ⬆️ ⬇️ ⬆️

Standby Level (%) 10 ⬆️ ⬇️ ⬆️

Use second load No ▾

13. COMMUNICATION OBJECTS (continued)**■ 13.3 Load (continued)****13.3.3 Standby time base (function only available in Master mode: detection and Master: Light level & Detection) (continued)****• Standby time base → Seconds**

A standby function, in seconds, is used. At the end of time delay the load decreases to standby level for the standby time in seconds.

Parameters	Settings
Delay	0-60
This parameter determines the time for the standby in seconds	
Standby level	0-100
This parameter determines the standby level (default value 10%)	

• Standby time base → Minutes

A standby function, in minutes, is used. At the end of time delay the load decreases to standby level for the standby time in minutes.

Parameters	Settings
Delay	0-60
This parameter determines the time for the standby in minutes	
Standby level	0-100
This parameter determines the standby level (default value 10%)	

• Standby time base → Infinite

An infinite standby function is used. At the end of time delay the load decreases to standby level for an infinite time.

Parameters	Settings
Standby level	0-100
This parameter determines the standby level (default value 10%)	

13. COMMUNICATION OBJECTS (continued)

■ **13.3 Load (continued)**

13.3.4 Use second load

Parameters	Settings
Use second load	Yes No

No: Switching second light and level second light cannot be used, no accessible communication objects

When use second load is yes: this object communication is available.

No.	Object name	Function	Size	Flags
22	Switching second light	Switching second light	1.001 DP_On/Off	CRT

Switching second light telegrams are sent via the group address linked to this object. Used to pilot on On/Off 2nd light with an offset compared to 1st load.

23	Level second light	Level second light	5.001 DP Percentage	CRT
----	--------------------	--------------------	---------------------	-----

Level second light telegrams are sent via the group address linked to this object. Used to pilot on dimming 2nd light with an offset compared to 1st load.

Parameters	Settings
Offset sign	Negative Positive

This parameter determines the sign of the offset value

Offset (%)	0-100
------------	-------

This parameter determines the offset value

13. COMMUNICATION OBJECTS (continued)

■ 13.4 Light level config

Page only available for Master: Light level Only and Master: Light level & Detection modes.

Parameters	Settings
Setpoint	0 Lux... 100 Lux ...1275 Lux

This parameter represents the set luminosity threshold to be maintained. It is expressed in Lux

13.4.1 Use external daylight cell

For light régulation you choose if you use lux value measured by the sensor (No) or you can use an external daylight cell (Yes) see below.

Parameters	Settings
Use external daylight cell	No Yes
Send condition	On request only On change Cyclical On change + Cyclical

On request only: The object value is updated but not sent
On change: The object value is sent when it changes
Cyclical: The object value is sent cyclically
On change + Cyclical: The object value is sent when it changes and cyclically

No.	Object name	Function	Size	Flags
8	Out Lux	Out Lux	9.004 DP_Lux	CRT

Out Lux values are sent via the group address linked to this object.
 Send operations can be set in ETS (Cyclical, on change, on request)

13. COMMUNICATION OBJECTS (continued)**■ 13.4 Light level config (continued)****13.4.1 Use external daylight cell (continued)****On change**

Parameters	Settings
Max. number of messages per minute	1-60
This parameter determines the maximum number of messages per minute	
Dead band	1-100
This parameter determines the percentage variation for validating a change	

Cyclical

The object value is sent cyclically

Parameters	Settings
Cyclical interval (seconds)	1-255
This parameter determines the timebase for sending lux in seconds	

On change + Cyclical

Parameters	Settings
Cyclical interval (seconds)	1-255
This parameter determines the timebase for sending lux in seconds	
Max. number of messages per minute	1-60
This parameter determines the maximum number of messages per minute. The value must be higher than the timebase/60.	
Dead band	1-100
This parameter determines the percentage variation for validating a change	

When use external daylight cell is yes: this object communication is available.

No.	Object name	Function	Size	Flags
7	In Lux	In Lux	9.004 DP_Lux	CW

In Lux values are received via the group address linked to this object.
The sensor reacts as if it had an internal daylight cell

Warning: When an external daylight cell is used, the provision of light must be set with the IR commissioning tool.

13. COMMUNICATION OBJECTS (continued)

■ 13.5 Detection config

Page only available for Master Detection Only and Master Light level & Detection modes.

No.	Object name	Function	Size	Flags
5	In Occupancy	In Occupancy	1.002 DP_Bool	CW

In Occupancy statuses are received via the group address linked to this object.
 True: The sensor reacts as if there was an internal detection
 False: No reaction

6	Out Occupancy	Out Occupancy	1.002 DP_Bool	CRT
---	---------------	---------------	---------------	-----

Out Occupancy statuses are sent via the group address linked to this object
 True: When motion detected
 False: After vacancy time delay, or occupancy if vacancy is not used

20	Out Synchro Master → Slave	Out Synchro Master → Slave	1.002 DP_Bool	CT
----	----------------------------	----------------------------	---------------	----

Out synchro Master-> Slave statuses are sent via the group address linked to this object
 True: The maintain status is sent to the slave
 False: The initial status is sent to the slave

Parameters	Settings
Use detection LED This parameter determines whether or not the detection LED is to be used when detection is active	Yes No
Time delay: hours This parameter determines the hours of the time delay	0-17
Time delay: minutes This parameter determines the minutes of the time delay	0-59
Time delay: seconds This parameter determines the seconds of time delay. If the total value is less than 5 s the time delay is automatically set to 5 s	0-59
Transfer In Occupancy to "Occupancy Status" This parameter determines how many "presence events" are transmitted on the bus. Is "yes" the presence events of all sensors being part of the master-slave configuration are passed on the KNX/BUS; This configuration is useful for an external supervisor. If "no" only the presence event of the master sensor is passed on the KNX/BUS Yes: you have the occupancy status for each sensors : master and slaves .usefull for exampmple in supervision No: you have one occupancy status for all sensors of the detection zone.You can use it to pilot a corridor for example.	Yes No

13. COMMUNICATION OBJECTS (continued)

■ **13.5 Detection config (continued)**

13.5.1 Send Condition

Page only available for Slave Detection Only mode.

General Detection config. Advanced ----- Commissioning Tool -----	Use detection led No ▼
	Minimum time between two sends (seconds) 5 ▲ ▼
	Send condition On request only ▼

Parameters	Settings
Send condition	On request only On change Cyclical On change + Cyclical

On request only: The object value is updated but not sent
On change: The object value is sent when it changes
Cyclical: The object value is sent cyclically
On change + Cyclical: The object value is sent when it changes and cyclically

On request only

The object value is updated but not sent

On change

The object value is sent when detection is validated

Parameters	Settings
Max. number of messages per minute	1-60

This parameter determines the maximum number of messages per minute

Cyclical

The object value is sent cyclically

Parameters	Settings
Cyclical interval (seconds)	1-255

This parameter determines the timebase for sending lux in seconds

On change + Cyclical

Parameters	Settings
Cyclical interval (seconds)	1-255

This parameter determines the timebase for sending lux in seconds

Max. number of messages per minute	1-60
---	------

This parameter determines the maximum number of messages per minute.
 The value must be higher than the timebase/60.

13. COMMUNICATION OBJECTS (continued)

13.6 Auxiliary output

Page only available for Master: Detection Only, Master: Light level & Detection and Slave: Detection Only modes

Parameters	Settings
Auxiliary object type	None Switching Scaled value HVAC Mode Scene 2 bytes value

13.6.1 None

The auxiliary output cannot be used, no accessible communication objects.

13.6.2 Switching

- General
- Load
- Light level config.
- Detection config.
- Auxiliary output
- Advanced
-
- Virtual keycard
- Commissioning Tool
-

Auxiliary object type		Switching ▼
Send on occupancy		Yes ▼
Value		Off ▼
Send on vacancy		Yes ▼
Value		Off ▼

No.	Object name	Function	Size	Flags
11	Switching Auxiliary	Switching Auxiliary	1.001 DP_On/Off	CT

Switching Auxiliary telegrams are sent via the group address linked to this object

Parameters	Settings
Send on Occupancy	Yes No
This parameter determines the reaction of the auxiliary on occupancy	
Value	On Off
This parameter determines the value to send on occupancy	
Send on Vacancy	Yes No
This parameter determines the reaction of the auxiliary on vacancy	
Value	On Off
This parameter determines the value to send on occupancy	

13. COMMUNICATION OBJECTS (continued)

■ **13.6 Auxiliary output (continued)**

13.6.3 Scaled values

General	Auxiliary object type	Scaled value
Load	Send on occupancy	Yes
Light level config.	Value	0
Detection config.	Send on vacancy	Yes
Auxiliary output	Value	0
Advanced		

Virtual keypad		
Commissioning Tool		

No.	Object name	Function	Size	Flags
11	Scaling Auxiliary	Scaling Auxiliary	5.001 DP_Scaling	CW

Scaling Auxiliary telegrams are sent via the group address linked to this object

Parameters	Settings
Send on Occupancy	Yes No
This parameter determines the reaction of the auxiliary on occupancy	
Value	0-100
This parameter determines the value to send on occupancy	
Send on vacancy	Yes No
This parameter determines the reaction of the auxiliary on vacancy	
Value	0-100
This parameter determines the value to send on vacancy	

13. COMMUNICATION OBJECTS (continued)

■ **13.6 Auxiliary output (continued)**

13.6.4 HVAC Mode

<ul style="list-style-type: none"> General Load Light level config. Detection config. <li style="background-color: #d0d0d0;">Auxiliary output Advanced ----- Virtual keycard Commissioning Tool ----- 	Auxiliary object type: HVAC Mode Send on occupancy: Yes Value: 0 Send on vacancy: Yes Value: 0
---	--

No.	Object name	Function	Size	Flags
11	HVAC Mode	HVAC Mode	20.102 DP_ HVACMode	CW

Percent auxiliary telegrams are sent via the group address linked to this object

Parameters	Settings
Send on Occupancy	Yes No
This parameter determines the reaction of the auxiliary on occupancy	
Value	0-255
This parameter determines the value to send on occupancy	
Send on vacancy	Yes No
This parameter determines the reaction of the auxiliary on vacancy	
Value	0-255
This parameter determines the value to send on vacancy	

13. COMMUNICATION OBJECTS (continued)

■ **13.6 Auxiliary output (continued)**

13.6.5 Scene

<ul style="list-style-type: none"> General Load Light level config. Detection config. <li style="border: 1px solid #ccc;">Auxiliary output Advanced ----- Virtual keycard Commissioning Tool ----- 	<p>Auxiliary object type Scene ▾</p> <p>Send on occupancy Yes ▾</p> <p>Value 1 ▲ ▼</p> <p>Send on vacancy Yes ▾</p> <p>Value 1 ▲ ▼</p>
--	---

No.	Object name	Function	Size	Flags
11	8-bit scene Auxiliary	8-bit scene Auxiliary	17.001 DP_SceneNumber	CW

8-bit scene auxiliary telegrams are sent via the group address linked to this object

Parameters	Settings
Send on Occupancy	Yes No
This parameter determines the reaction of the auxiliary on occupancy	
Value	1-64
This parameter determines which scene (1..64) to send on occupancy. If value "0" is set, no scene will be recalled.	
Send on vacancy	Yes No
This parameter determines the reaction of the auxiliary on vacancy	
Value	1-64
This parameter determines which scene (1..64) to send on vacancy. If value "0" is set, no scene will be recalled.	

13. COMMUNICATION OBJECTS (continued)

■ **13.6 Auxiliary output (continued)**

13.6.6 2 bytes value

General	Auxiliary object type	2 bytes value
Load	Send on occupancy	Yes
Light level config.	Value	0
Detection config.	Send on vacancy	Yes
Auxiliary output	Value	0
Advanced		

Virtual keycard		
Commissioning Tool		

No.	Object name	Function	Size	Flags
11	2-byte unsigned Auxiliary	2-byte unsigned Auxiliary	9.001 DP_Value_Temp	CRT

2-bytet unsigned auxiliary telegrams are sent via the group address linked to this object

Parameters	Settings
Send on Occupancy	Yes No
This parameter determines the reaction of the auxiliary on occupancy	
Value	0-65535
This parameter determines the value to send on occupancy	
Send on vacancy	Yes No
This parameter determines the reaction of the auxiliary on vacancy	
Value	0-65535
This parameter determines the value to send on vacancy	

13. COMMUNICATION OBJECTS (continued)

■ **13.7 Advanced**

Page only available for Master: Detection Only, Master: Light level Only and Master: Light level & Detection modes.

General	US sensitivity	High
Load	IR sensitivity	Very high
Light level config.	Initial scheme	PIR AND US
Detection config.	Maintain scheme	PIR OR US
Auxiliary output	Additional Object : setpoint	No
Advanced	Additional Object : Time delay	No

Virtual keycard		
Commissioning Tool		

13.7.1 Sensitivity (only available for Master: Detection Only, Master: Light level & Detection and Slave: Detection Only modes)

Parameters	Settings
US sensitivity	Low Medium High Very high
This parameter determines the sensitivity of ultrasound sensors	
PIR sensitivity	Low Medium High Very high
This parameter determines the sensitivity of PIR sensors	

13.7.2 System detection (only available for Master: Detection Only, Master: Light level & Detection and Slave: Detection Only modes)

Parameters	Settings
Initial scheme	PIR only US only PIR and US PIR or US
This parameter determines the sensor detection system for initialising motion detection	
Maintain scheme	PIR only US only PIR and US PIR or US
This parameter determines the sensor detection system for maintaining motion detection	

13. COMMUNICATION OBJECTS (continued)**■ 13.8 Advanced (continued)****13.7.3 Additional object for expert mode**

Here should be explained the 2 objects "Additional object: setpoint" and "Additional object: Time delay"

With these 2 "Additional object, you change parameters setpoint and Time delay" of the sensors by a supervisor for example.

Parameters	Settings
Additional Object: setpoint	No Yes
No: Additional object cannot be used, no accessible communication objects	
Additional Object: Timedelay	No Yes
No: Additional object cannot be used, no accessible communication objects	

When additional object setpoint and time delay is yes: this object communication is available.

No.	Object name	Function	Size	Flags
15	Setpoint	Setpoint	9.004 DP_Lux	CRW

Occupancy setpoints are received via the group address linked to this object.

You can change day light level via the group address linked to this object.

*Only accessible if internal or external daylight cell is used.

17	TimeDelay	TimeDelay	7.005 DP_Time_Period_Sec	CRW
----	------------------	------------------	---------------------------------	------------

Occupancy TimeDelays are received via the group address linked to this object.

If the value received is less than 5 s the time delay is set automatically to 5 s.

You can change the value by supervisor.

If the value received.

19	Recall	Recall	1.010 DP_Start/stop	CW
----	---------------	---------------	----------------------------	-----------

Recalls are received via the group address linked to this object.

Start: Recalls the initial values of Setpoint and TimeDelay; the values configured before the changes operated via objects.

Stop: No reaction.

13. COMMUNICATION OBJECTS (continued)

13.8 Virtual Keycard

The function is triggered by the "door contact" event which launch the so called "Virtual keycard time delay", a time offset in which the sensor understand if the room is occupied or not, based on some informations: sensor detection, door contact events, push buttons event. Once the result of the function is "occupied" it remains until there is another "Door contact event" which trigger another "Virtual keycard time delay" to understand the room status and eventually turn OFF the lights, launch an absence scenario or launch any other logic related to vacancy event.

Page only available for Master Detection Only and Master Light level & Detection modes.

General	Use virtual keycard	Yes
Load	Sensitivity	Low
Light level config.	Window time (min.)	10
Detection config.	Door event condition	Rising edge (0->1)
Auxiliary output	External event object type	None
Advanced	Occupied object type	No
-----	Unoccupied object type	No
Virtual keycard	Send status when	Never
Commissioning Tool		

13.8.1 Use Virtual Keycard

Parameters	Settings
Use virtual keycard	No Yes

No: The virtual keycard function cannot be used, no accessible communication objects

When use virtualkeycard is yes: this object communication is available.

No.	Object name	Function	Size	Flags
31	Virtual Keycard	Door contact	1.001 DP_On/Off	CRWTU

VKC_Door_contact telegrams are received via the group address linked to this object

33	Virtual Keycard	Status	1 bit	CT
----	-----------------	--------	-------	----

VKC Statuses are sent via the group address linked to this object

36	Virtual Keycard	In detection	1.003 DP_Boolean	CW
----	-----------------	--------------	------------------	----

VKC in detection telegrams are received via the group address linked to this object

With object 36 is possible to associate others sensors and extend the detection zone of the first sensor.

13. COMMUNICATION OBJECTS (continued)**■ 13.8 Virtual Keycard (continued)****13.8.1 Use Virtual Keycard (continued)****13.8.1.1 Sensitivity**

Parameters	Settings
Sensitivity	Low Medium High Very high

This parameter determines the numbers of detections needed to confirm presence.

Low: 5 detections in 20 seconds

Medium: 4 detections in 20 seconds

High: 3 detections in 20 seconds

Very high: 2 detections in 20 seconds

13.8.1.2 Window time (min)

Parameters	Settings
Window time (min)	3-255

This parameter is the "Virtual keycard time delay". It determines the delay after a door contact in which the sensor check if there is presence and change the status from absence (object status=0) to presence (object status=1).

13.8.1.3 Door event condition

Parameters	Settings
Door event condition	Rising edge 0 → 1 Falling edge 1 → 0

This parameter determines the door event condition on the VKC door contact object.

It determines if the « door contact event » is measured on the rising or falling edge

No.	Object name	Function	Size	Flags
31	Virtual Keycard	Door contact	1.001 DP_On/Off	CRWTU

VKC_Door_contact telegrams are received via the group address linked to this object

13. COMMUNICATION OBJECTS (continued)

■ **13.8 Virtual Keycard (continued)**

13.8.1 Use Virtual Keycard (continued)

13.8.1.4 External event object type

External event object type	Switch
External event comparator	==
Compared value	Off

Parameters	Settings
External event object type	None Switch Scaled value Scene 2-bytes 4-bytes

This parameter determines the Data point type of the VKC external object. This object is used to improve the function effectiveness, it is an additional object used to confirm the presence information. It can be a command switch, detection in the room, window contact...

External event comparator	== (equal) != (different) < (less than) <=(less than or equal) >(greater than) >=(greater than or equal)
----------------------------------	--

This parameter determines the type of comparison between the value on a VKC external object and the value to be compared

Compared value	On (Switch) Off (Switch) 0-100 (Scaled value) 1-64 (Scene) 0-64 (Scene) 0-65535 (2-bytes) 0-4294967295 (4 bytes)
-----------------------	--

This is the type of value to be compared

No.	Object name	Function	Size	Flags
32	Virtual Keycard	External event	DPT depend on the choice made in the settings	CW

VKC_external event telegrams are received via the group address linked to this object. DPT depend on the choice made in the settings

13. COMMUNICATION OBJECTS (continued)

■ **13.8 Virtual Keycard (continued)**

13.8.1 Use Virtual Keycard (continued)

13.8.1.5 Occupied and Unoccupied object type

Action on presence and absence event.

Occupied object type

Unoccupied object type

Parameters	Settings
Occupied object type	No Switch Scaled value HVAC Mode Scene 2-bytes value

This parameter determines the Data point type of the VKC presence action object

Value	On (Switch) Off (Switch) 0-100 (Scaled value) 0-255 (HVAC Mode) 1-64 (Scene) 0-65535 (2-bytes)
--------------	--

Value to send to the VKC occupied object

Unoccupied type object	No Switch Scaled value HVAC Mode Scene 2-bytes value
-------------------------------	--

This parameter determines the Data point type of the VKC absence action object

Value	On (Switch) Off (Switch) 0-100 (Scaled value) 0-255 (HVAC Mode) 1-64 (Scene) 0-65535 (2-bytes)
--------------	--

Value to send to the VKC Unoccupied object

• **Example with a Switch object type**

Occupied object type

Value

Unoccupied object type

Value

No.	Object name	Function	Size	Flags
34	Virtual Keycard	VKC_presence_action_1bit	Switch	CT

VKC presence actions are sent via the group address linked to this object.
DPT depend on the choice made in the settings

35	Virtual Keycard	VKC_absence_action_1bit	Switch	CT
----	-----------------	-------------------------	--------	----

VKC absence actions are sent via the group address linked to this object.
DPT depend on the choice made in the settings

13. COMMUNICATION OBJECTS (continued)

■ **13.8 Virtual Keycard (continued)**

13.8.1 Use Virtual Keycard (continued)

13.8.1.6 Send status when

Send status when

Parameters	Settings
Send status when	Never Occupied only Unoccupied only Occupied & unoccupied

This parameter determines when to send a value on the VKC status object
Never: No value sent to VKC status, but can be read on request
Occupied: Only occupied is sent to VKC status (Occupied)
Unoccupied: Only unoccupied is sent to VKC status (Not occupied)
Occupied & unoccupied: Both are sent to VKC status (Occupied and Not occupied)

13.8.2 Virtual keycard function operating diagram

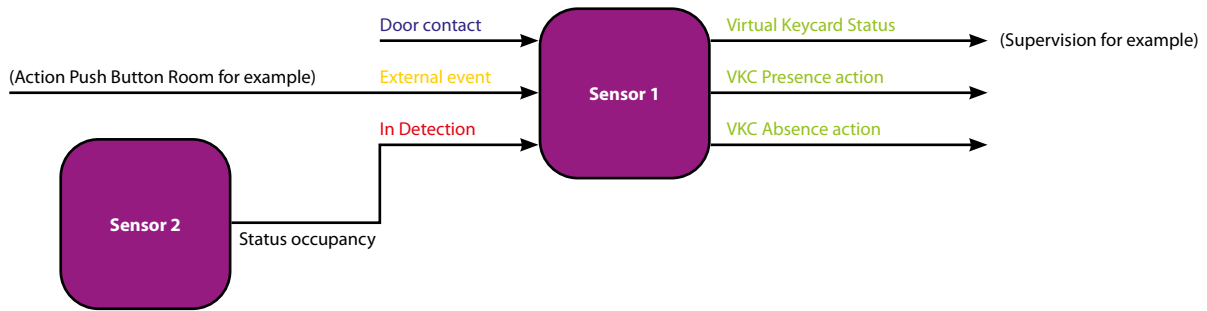

Virtual keycard behaviour:

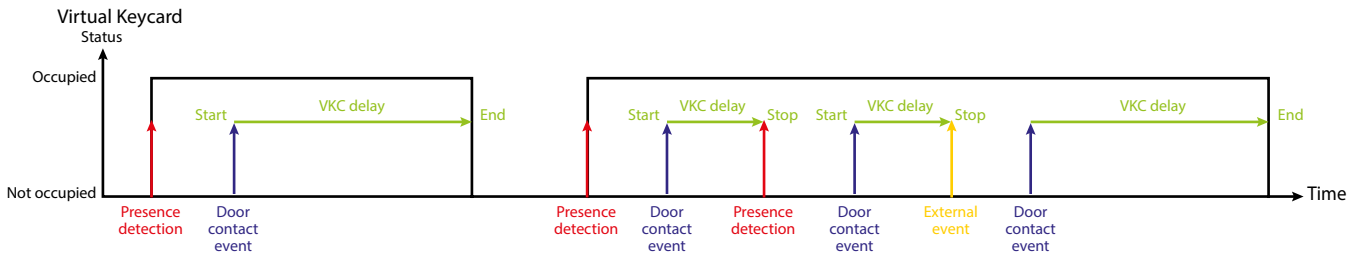

VKC function is triggered by "door contact" event after which begins the "VCK time delay" to understand if there is or not presence in the room. If during this time offset nothing is detected the result of the function is "vacancy" and the logics tied to the VKC function are not activated (first half of the above diagram). In case of detection during the time offset the result of the function is "occupancy", the "VCK time delay" is stopped and the related logics are triggered (second half of the above diagram). The VCK time delay restarts after another "door contact event". During the "VCK time delay" the "occupancy" status can be determined by the combination of more events: presence sensor "detection event" or external events (window contact, push-button pressure...).

13. COMMUNICATION OBJECTS (continued)

■ 13.9 Commissioning Tool

General	Use commissioning tool <input type="text" value="Yes"/>
Load	
Light level config.	
Detection config.	
Auxiliary output	
Advanced	

Virtual keycard	
Commissioning Tool	

Parameters	Settings
Use commissioning tool	Yes No
<i>No:</i> The sensor parameters can be only read with the commissioning tool <i>Yes:</i> The sensor parameters can be changed with the commissioning tool	
No: modification are saved	No Yes
<i>No:</i> Modifications are saved to the memory but change when a new application with ETS is downloaded <i>Yes:</i> Modifications are applied for 1 hour 30 minutes after the product has reloaded the default value; or if the product is disconnected from the bus, the default value is reloaded when the product is reconnected	

13. COMMUNICATION OBJECTS (continued)

■ **13.10 Pushbutton**

13.10.1 Pushbutton function

13.10.1.1 Function: Not used

The pushbutton cannot be used, no accessible communication objects

13.10.1.2 Function: Switching

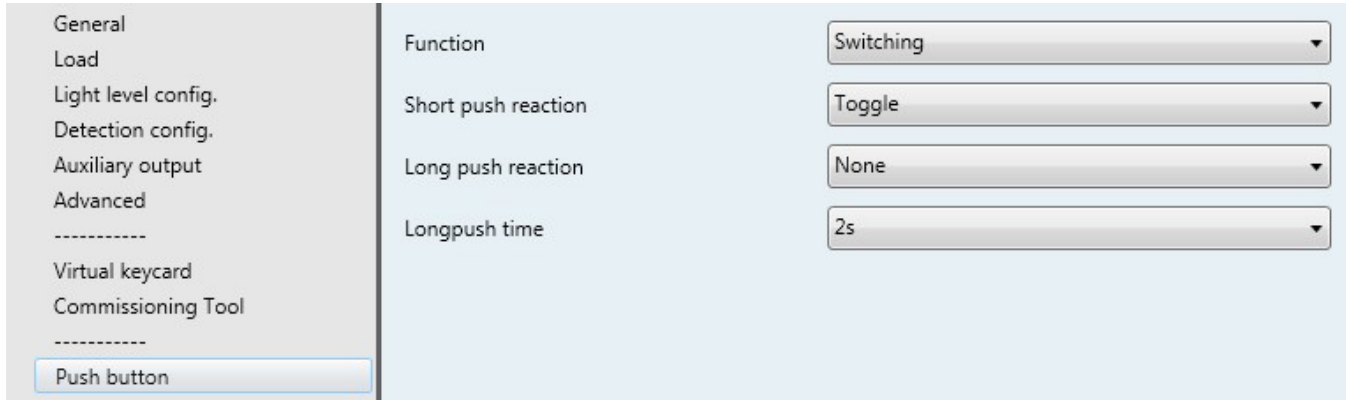

No.	Object name	Function	Size	Flags
25	BP_Switching	Switching_Push_Button	1.001 DP_On/Off	CWT

Switching pushbutton telegrams are sent via the group address linked to this object

30	BP_Enable	Enable_Push_Button	1.003 DP_Enable	CRW
----	-----------	--------------------	-----------------	-----

Disable telegrams are received via the group address linked to this object. They are used to lock (disable) or unlock (enable) the pushbutton

Parameters	Settings
Short push reaction	None On Off Toggle

Here an adjustment is made to define which switching value is written to the storage cell of the communication object and sent after a short press on the pushbutton attached to the input.

"None": A short press on the pushbutton does not change the object value and also does not lead to a telegram being sent.

"On": After a short press on the pushbutton, the switching value "ON" (binary value, "1") is transferred to the communication object and sent.

"Off": After a short press on the pushbutton, the switching value "OFF" (binary value,"0") is transferred to the communication object and sent.

"Toggle": After a short press on the pushbutton, the switching value stored in the communication object is inverted and the new value is sent.

Long push reaction	None On Off Toggle
---------------------------	------------------------------------

Here an adjustment is made to define which switching value is written to the storage cell of the communication object and sent after a long press on the pushbutton attached to the input.

"None": A long press on the pushbutton does not change the object value and also does not lead to a telegram being sent.

"On": After a long press on the pushbutton, the switching value "ON" (binary value, "1") is transferred to the communication object and sent.

"Off": After a long press on the pushbutton, the switching value "OFF" (binary value,"0") is transferred to the communication object and sent.

"Toggle": After a long press on the pushbutton, the switching value stored in the communication object is inverted and the new value is sent

Long push time	0.5 s 1 s 2 s 3 s 4 s 5 s 10 s
-----------------------	---

This parameter determines the minimum period for detecting a long press on the pushbutton

13. COMMUNICATION OBJECTS (continued)

■ **13.10 Pushbutton (continued)**

13.10.1 Pushbutton function (continued)

13.10.1.3 Function: Dimming

General	Function	Dimming
Load	Short push reaction	Toggle
Light level config.	Long push reaction	Cyclical Dim +/-
Detection config.	Longpush release	Dim Stop
Auxiliary output	Longpush time	2s
Advanced		

Virtual keycard		
Commissioning Tool		

Push button		

No.	Object name	Function	Size	Flags
25	BP_Switching	Switching_Push_Button	1.001 DP_On/Off	CWT

Switching pushbutton telegrams are sent via the group address linked to this object

27	BP_Dimming	Dimming Push Button	3.007 DP_dimming control	CT
----	------------	---------------------	--------------------------	----

Level telegrams are sent via the group address linked to this object

30	BP_Enable	Enable_Push_Button	1.003 DP_Enable	CRW
----	-----------	--------------------	-----------------	-----

Disable telegrams are received via the group address linked to this object. They are used to lock (disable) or unlock (enable) the pushbutton

Parameters	Settings
<p>Short push reaction</p> <p>Here an adjustment is made to define which switching value is written to the storage cell of the communication object and sent after a short press on the pushbutton attached to the input.</p> <p><i>"None"</i>: A short press on the pushbutton does not change the object value and also does not lead to a telegram being sent.</p> <p><i>"On"</i>: After a short press on the pushbutton, the switching value "ON" (binary value, "1") is transferred to the communication object and sent.</p> <p><i>"Off"</i>: After a short press on the pushbutton, the switching value "OFF" (binary value, "0") is transferred to the communication object and sent.</p> <p><i>"Toggle"</i>: After a short press on the pushbutton, the switching value stored in the communication object is inverted and the new value is sent.</p>	<p>None</p> <p>On</p> <p>Off</p> <p>Toggle</p>
<p>Long push reaction</p> <p>Here an adjustment is made to define which dimming value is written to the storage cell of the communication object and sent after a long press on the pushbutton attached to the input.</p> <p><i>"None"</i>: A long press on the pushbutton does not change the object value and also does not lead to a telegram being sent.</p> <p><i>"Cyclical dim +/-"</i>: After a long press on the pushbutton, the dimming value stored in the communication object is inverted and the new value is sent.</p>	<p>None</p> <p>Cyclical dim +/-</p>
<p>Long push release</p> <p>Here an adjustment is made to define which dimming value is written to the storage cell of the communication object and sent when a long press on the pushbutton attached to the Channel is released</p> <p><i>"None"</i>: A long press on the pushbutton does not change the object value and also does not lead to a telegram being sent.</p> <p><i>"Dim stop"</i>: When the pushbutton is released after a long press, the dimming value "Stop" is transferred to the communication object and sent.</p>	<p>None</p> <p>Dim stop</p>
<p>Long push time</p> <p>This parameter determines the minimum period for detecting a long press on the pushbutton</p>	<p>0.5 s</p> <p>1 s</p> <p>2 s</p> <p>3 s</p> <p>4 s</p> <p>5 s</p> <p>10 s</p>

13. COMMUNICATION OBJECTS (continued)

■ **13.10 Pushbutton (continued)**

13.10.1 Pushbutton function (continued)

13.10.1.4 Function: 8-bit scene control

No.	Object name	Function	Size	Flags
29	BP_Outscene	Outscene_ Push_Button	1.001 DP_On/Off	CWT

Switching pushbutton telegrams are sent via the group address linked to this object

30	BP_Enable	Enable_ Push_Button	1.003 DP_Enable	CRW
----	-----------	------------------------	-----------------	-----

Disable telegrams are received via the group address linked to this object. They are used to lock (disable) or unlock (enable) the pushbutton

Parameters	Settings
Scene number	1-64
This parameter determines which scene (1-64) is to be recalled on a rising edge when mode 1 is active If value "0" is set, no scene will be recalled	

14. APPLICATION'S EXAMPLES

Following are described some common applications.

Here are listed the involved products and the needed objects, to be connected, in order to realize the described functions.

■ 14.1 Mode Auto ON/OFF – Load ON/OFF

The represented associations are valid in the following configuration cases:

- light level only with regulation
- detection only without regulation
- light level and detection without regulation
- light level and detection with regulation

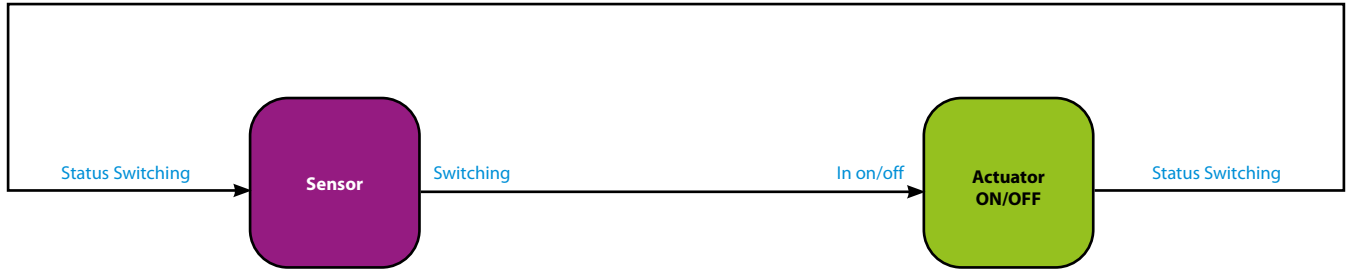

■ 14.2 Mode Auto ON/OFF – Dimming load

The represented associations are valid in the following configuration cases:

- detection only without regulation
- light level only with regulation
- light level and detection without regulation
- light level and detection with regulation

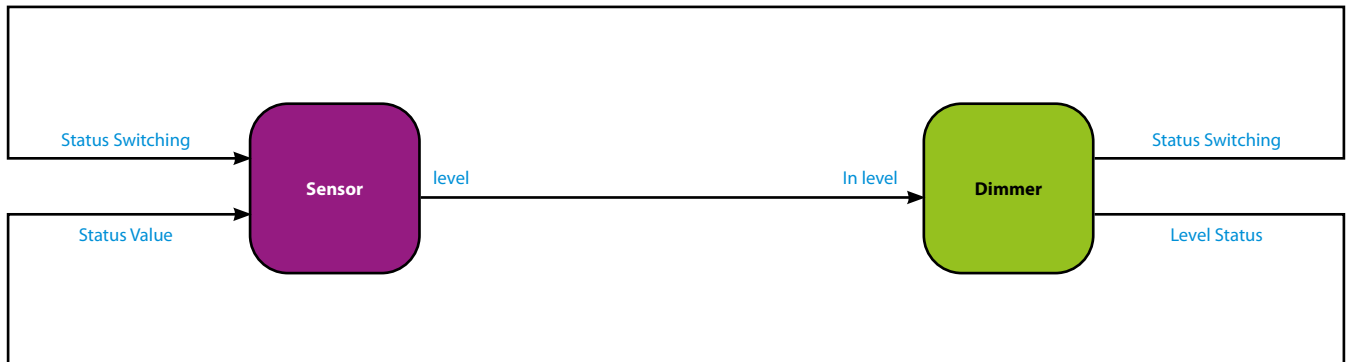

■ 14.3 Mode Manual ON/Auto OFF – Load ON/OFF

The represented associations are valid in the following configuration cases:

- detection only without regulation
- light level only with regulation
- light level and detection without regulation
- light level and detection with regulation

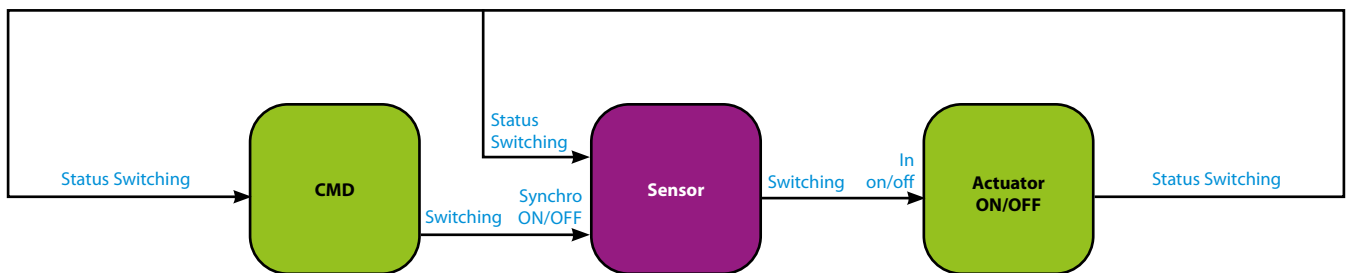

13. APPLICATION'S EXAMPLES (continued)

■ 14.4 Mode Manual ON/AutoOFF – Dimming load

The represented associations are valid in the following configuration cases:

- detection only without regulation
- light level only with regulation
- light level and detection without regulation
- light level and detection with regulation

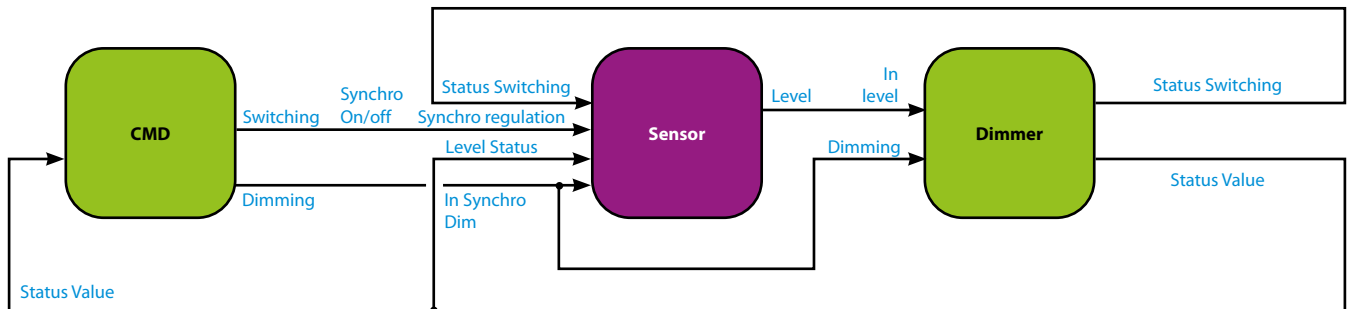

■ 14.5 Master/Slave detection

The represented associations are valid in the following configuration cases:

Ex: without regulation/load ON/OFF

