



	230 V~ +/- 10 %
	50 Hz
	1.5 mm ²
	- 10 °C / + 30 °C
	PIR
	1000 lux
	20 min.
	Auto ON / OFF
	2.8 m ø 7 m

L/OUT

230 V~	6 A	6 A	3 A	6 A

230 V~	6 A	3 A	3 A	3 A

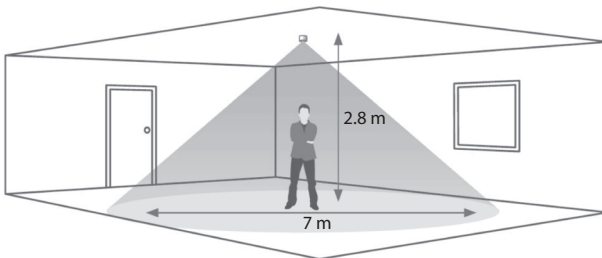

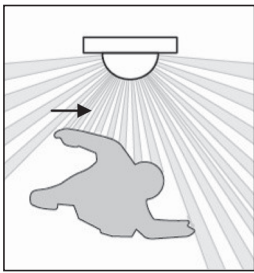

• Hauteur • Height • Altezza	• Diamètre • Range diameter • Diametro
7 m	16 m
2.8 m	9 m

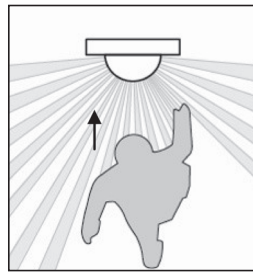

• Hauteur • Height • Altezza	• Diamètre • Range diameter • Diametro
7 m	10 m
2.8 m	5 m

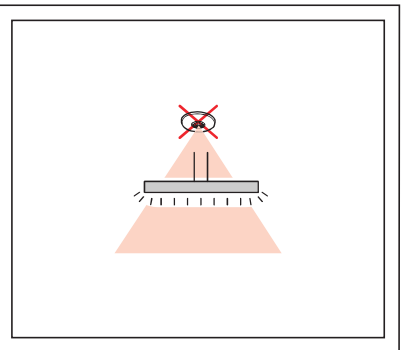
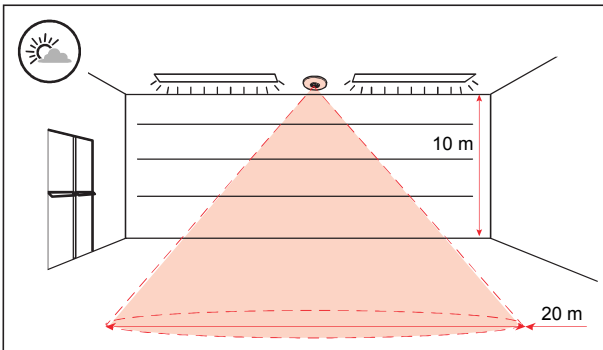
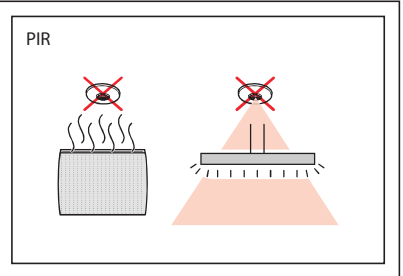
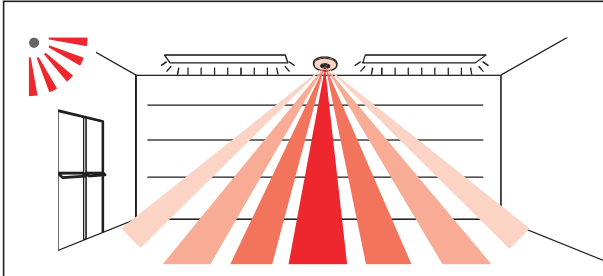

- Tête de détection
- Sensor head
- Testa di rilevamento

- Pousoir optionnel pour commande manuelle de variation et extinction
- Optional momentary switch for dimming and absence detection
- Pulsante opzionale per il controllo manuale di variazione e spegnimento

- Utiliser un câble secteur pour le câblage externe
- Use mains rated cable for external wiring
- Utilizzare un cavo di alimentazione per il cablaggio esterno

- La longueur de câble maximale entre la tête de détection et le bloc de puissance est de 1 mètre
- The maximum cable length between sensor head and power unit is 1 meter
- La lunghezza massima del cavo tra la testa di rilevamento e l'unità di potenza est di 1 metro

• **Fixation en saillie**

Utiliser les ergots à l'arrière du détecteur pour fixation sur une tôle mince (1 mm max.).

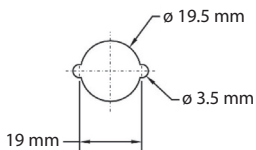

• **Surface mounting**

Use the lugs on rear of detector to secure into thin sheet metal (1 mm max.)

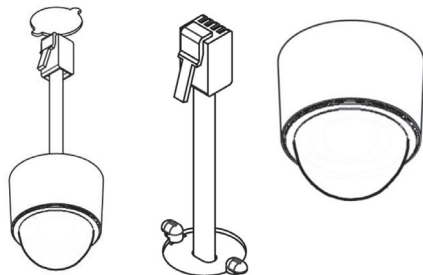

• **Montaggio in superficie**

Utilizzare le linguette sul retro del rivelatore per fissare in lamiera sottile (1 mm max.).

• **Fixation latérale**

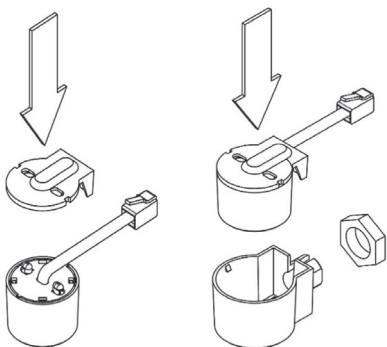

• **Side mounting**

• **Montaggio laterale**

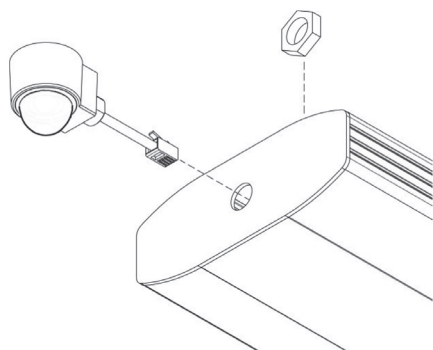

• **Fixation encastrée**

Le produit peut être monté avec l'accessoire de montage encastré comme indiqué. En cas de montage encastré dans un matériau de plus de 6 mm d'épaisseur, retirez la base des languettes de fixation avec un cutter. Un trou de 32 mm de diamètre sera nécessaire pour insérer l'accessoire de montage encastré.

• **Flush mounting**

The product can be mounted using the flush mount ring as shown. If flush mounting in a material that is greater than 6 mm thick, remove bottom of retention arms with side cutters. A 32 mm diameter hole will be required to insert the flush mount ring.

• **Montaggio a filo**

Il prodotto può essere montato con l'accessorio da incasso come mostrato. In caso di montaggio a filo in materiale di spessore superiore a 6 mm, rimuovere la base delle linguette di fissaggio con un cutter. Un foro di 32 mm di diametro sarà necessario per inserire l'accessorio da incasso.

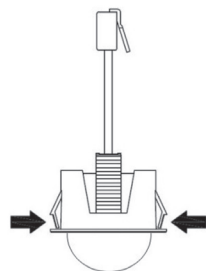
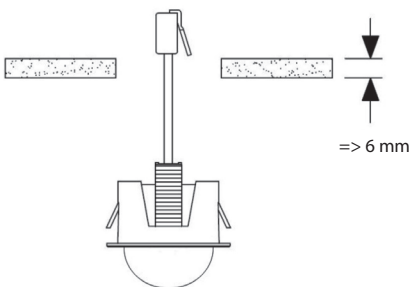
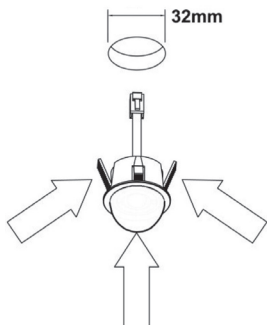

- Retirer la base des 2 languettes de fixation
- Remove bottom of 2 small retention arms
- Rimuovere la base delle 2 linguette di fissaggio



Auto ON / OFF

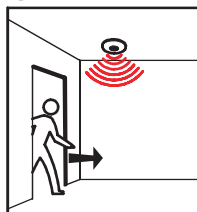

Manual ON / Auto OFF

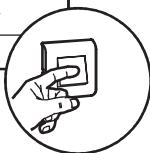

www.legrandoc.com

0 882 40



Legrand Close Up



0-1000 lux



0-99 min.



1-9

Mode

Auto - Manual

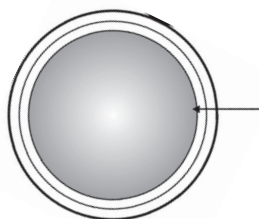

- Lentille PIR / récepteur IR / capteur de luminosité / LED d'état
- PIR lens / IR Receiver / Light Level Sensor / Status LED
- Lente PIR / ricevitore IR / sensore luminosità / LED di stato

• Pour la configuration, il est nécessaire d'effectuer une opération d'initialisation proposée dans l'application de configuration Legrand Close Up :

1 – cliquer sur "lecture des paramètres produits"

2 – cliquer sur "détails de paramètres / copier"

3 – dans le menu en haut à droite (...) sélectionner "Initialiser"

4 – cliquer sur "écriture des paramètres produits"

Cette opération permet le réglage prédéfini de certains paramètres.

• For configuration, it is necessary to operate an operation for initialization proposed in the Legrand Close Up application:

1 – click on "new scan"

2 – click on "see details"

3 – from the menu at the top right (...) select the action "Initialise"

4 – click on "upload configuration"

This operation allows the predefined setting of some parameters.

• Per la configurazione, è necessario eseguire un'operazione di inizializzazione proposta nell'applicazione Legrand Close Up:

1 – clicca su "leggi i parametri del prodotto"

2 – clicca su "dettagli parametro"

3 – dal menu in alto a destra (...) selezionare "Inizializza"

4 – clicca su "scrivi parametri prodotto"

Questa operazione consente l'impostazione predefinita di alcuni parametri.