

	16 M	24 M	36 M	16/24/36 M
DPX³ 630				
3 P	3 387 00 	3 387 03 	3 387 06 	3 387 50/53/56 
4 P	3 387 01 	3 387 04 	3 387 07 	3 387 51/54/57 
4 P + ELCB			3 387 07 	3 387 58 

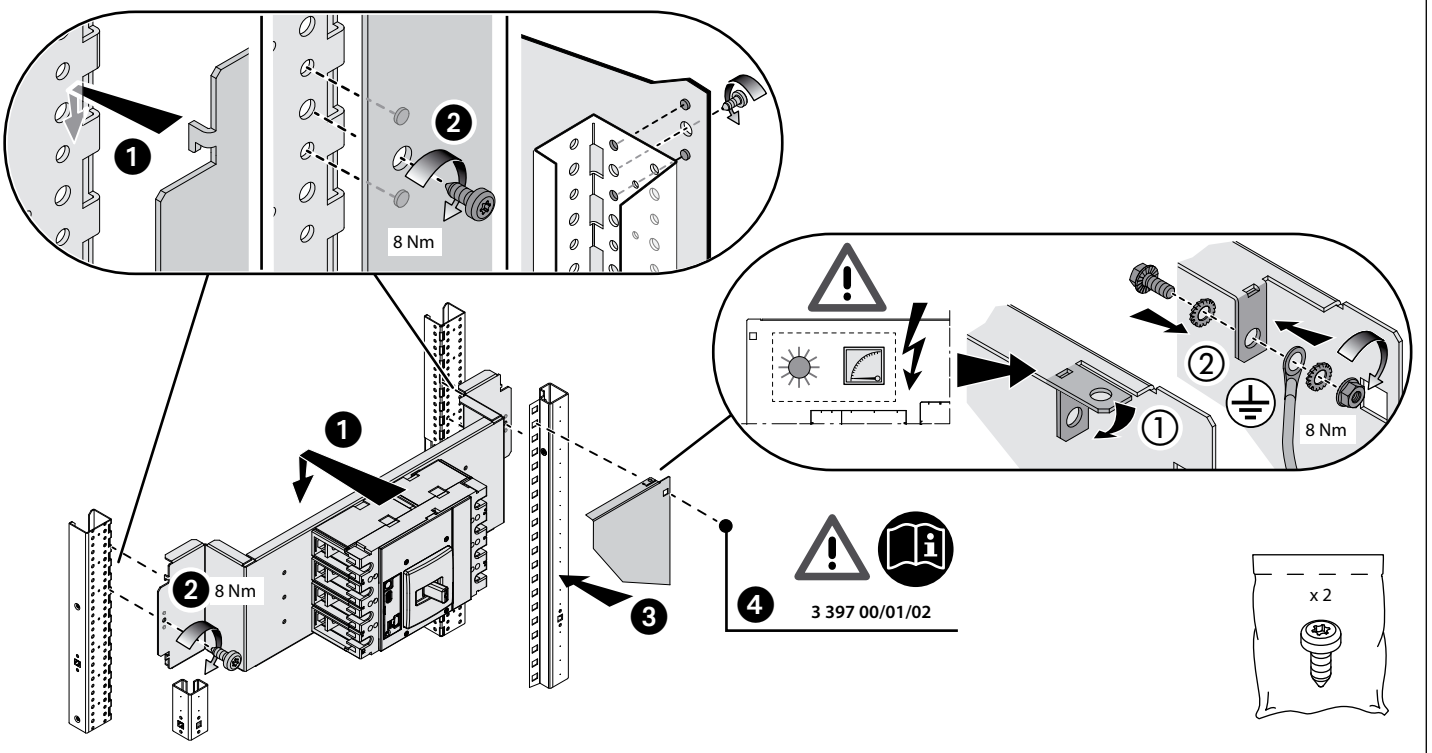

3 397 00/01/02

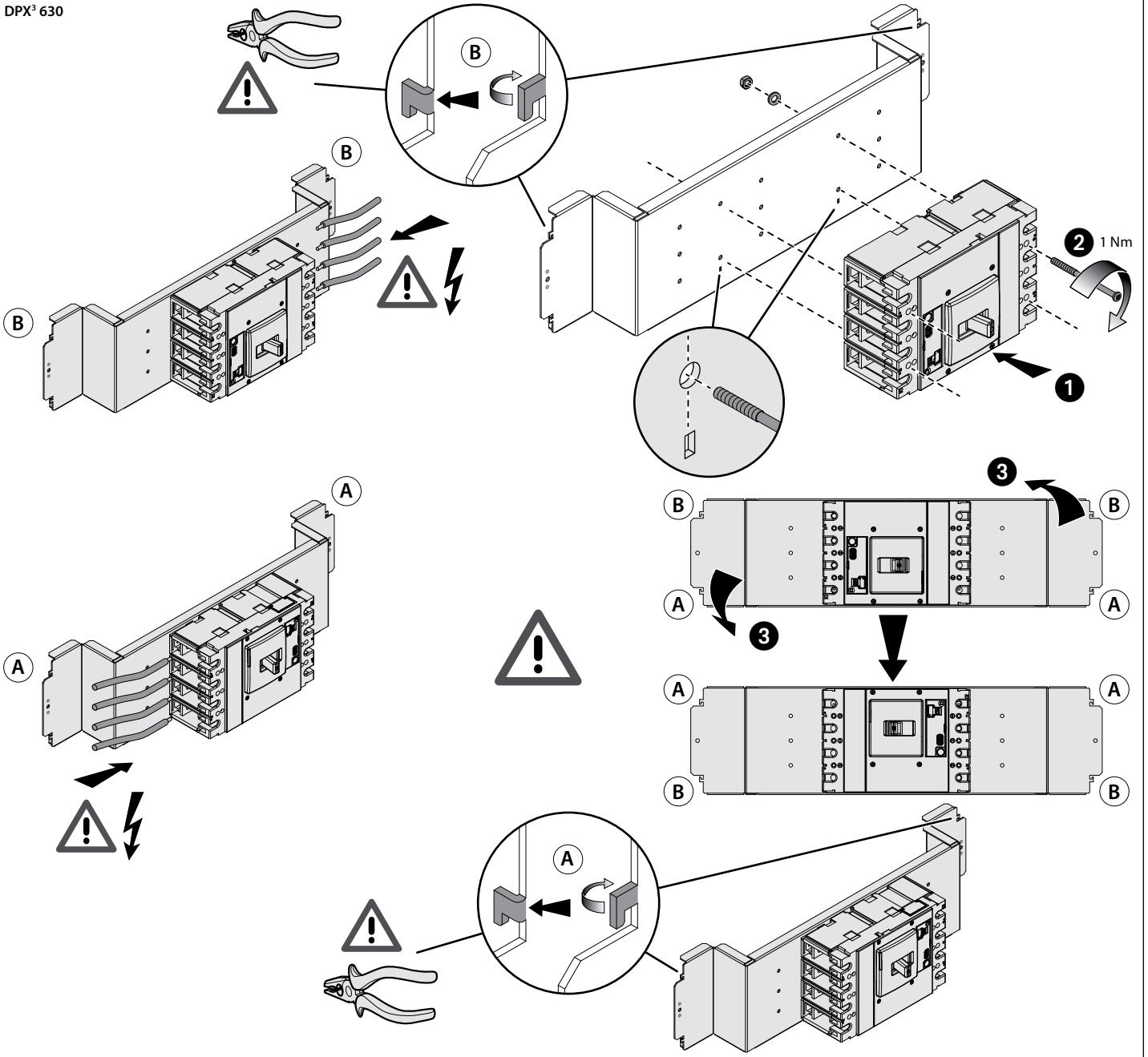

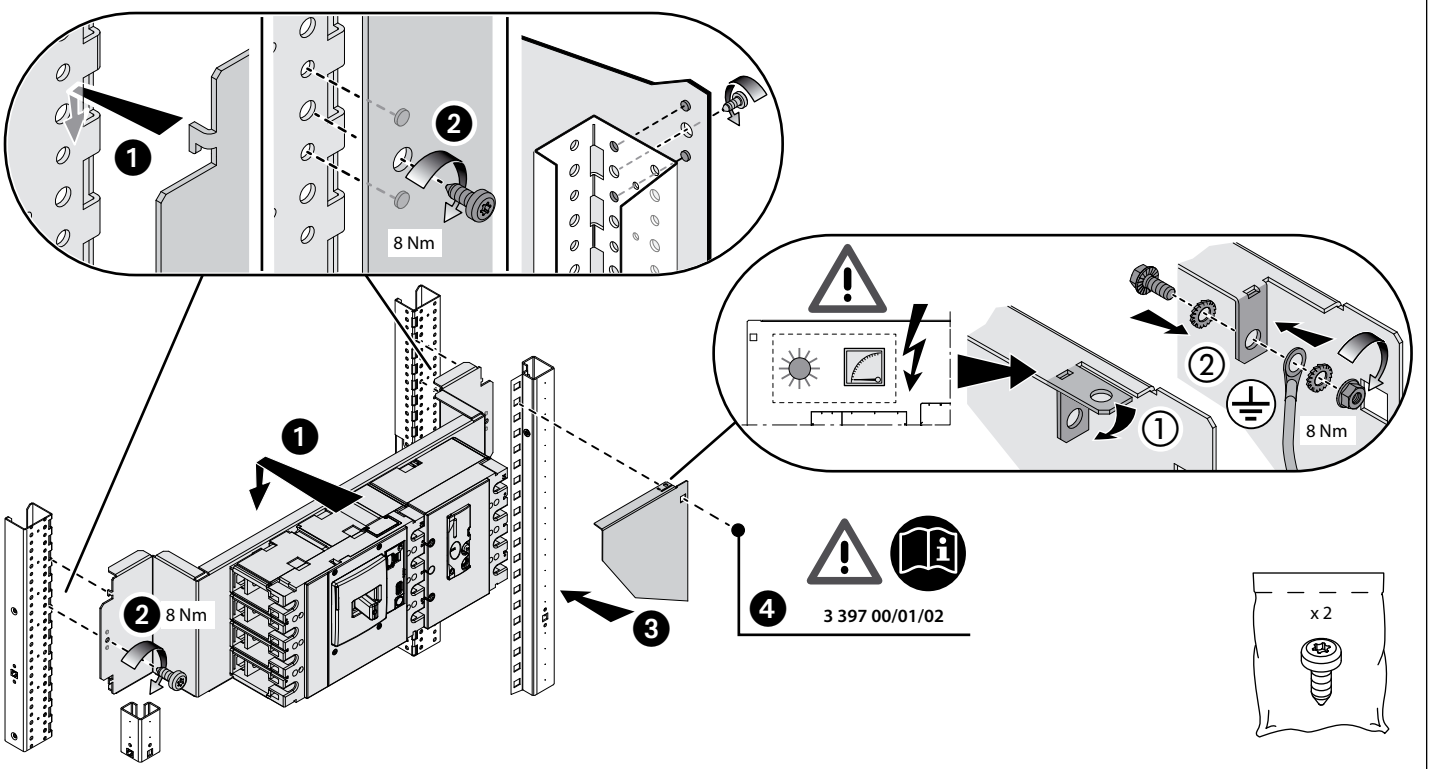
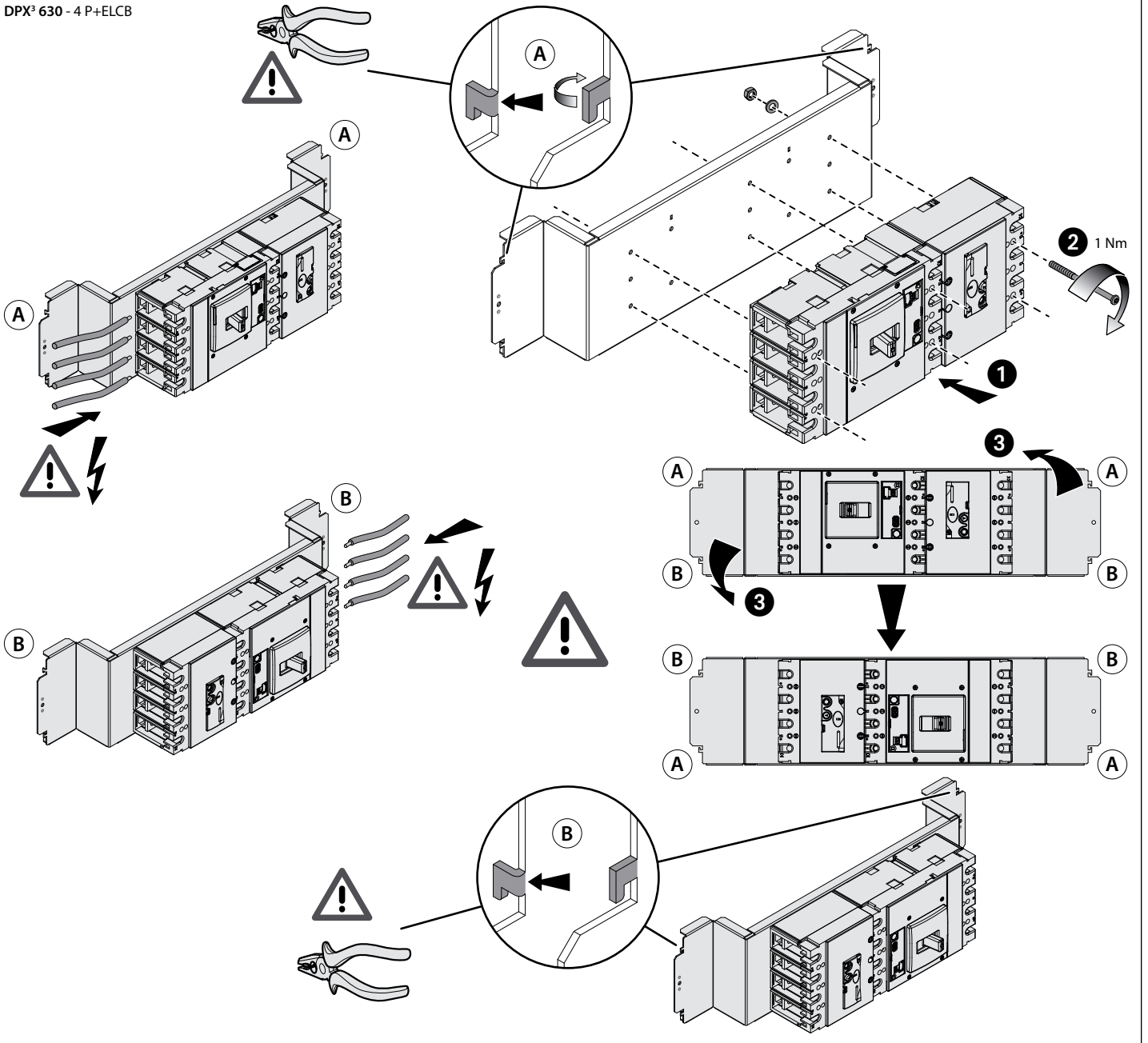

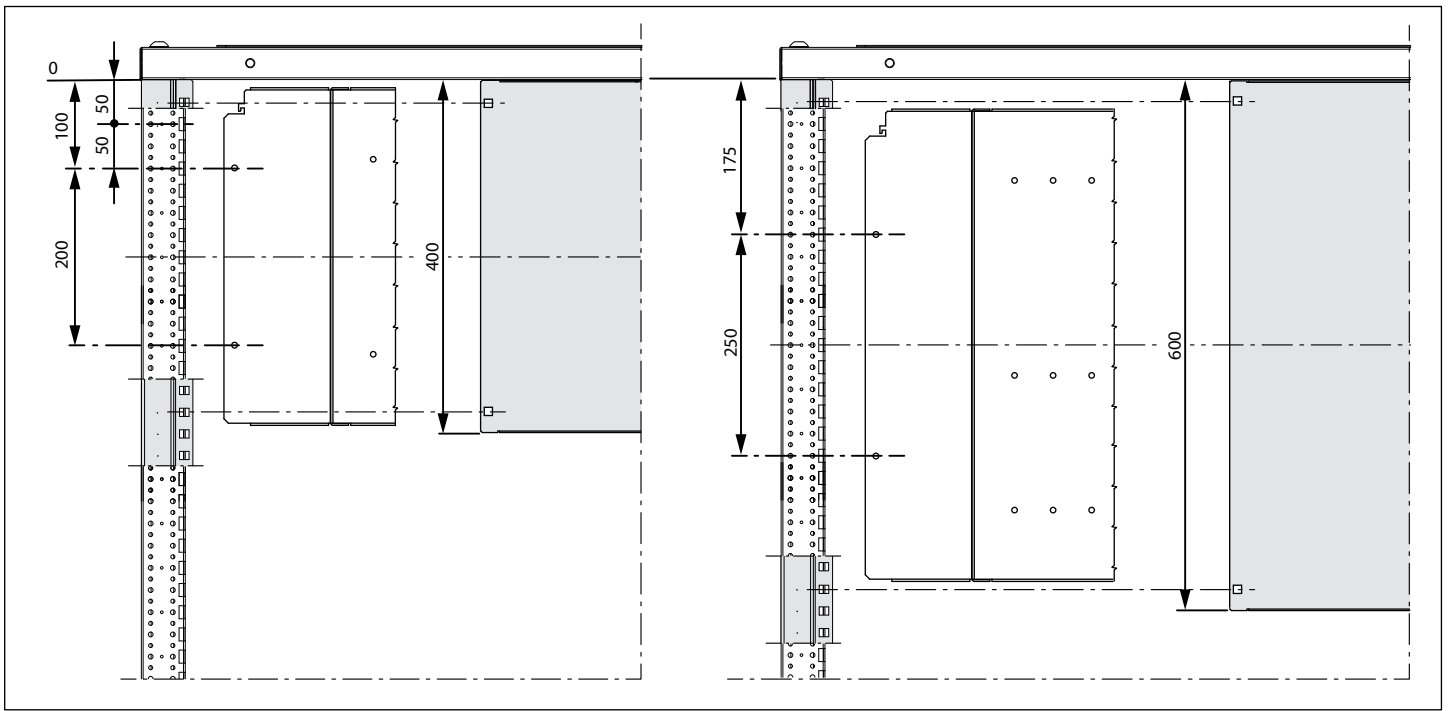

DPX <sup>3</sup> 630	16 M	24 M	36 M	16/24/36 M
3 P / 4 P 	3 387 20 	3 387 24 	3 387 27 	3 387 70/74/77 
3 P / 4 P 		3 387 24 	3 387 27 	3 387 70/74/77 
4 P + ELCB 	3 387 21 	3 387 25 	3 387 28 	3 387 71/75/78 
4 P + ELCB 		3 387 25 	3 387 28 	3 387 71/75/78 

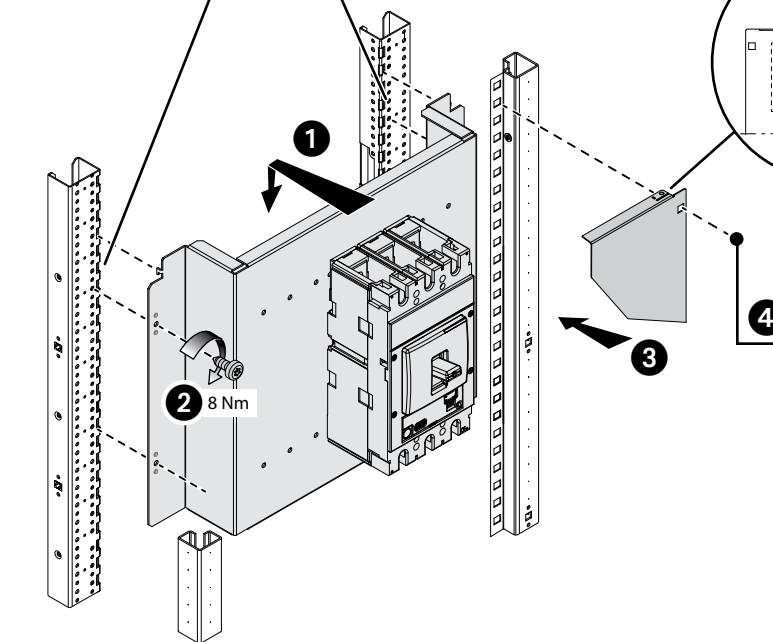
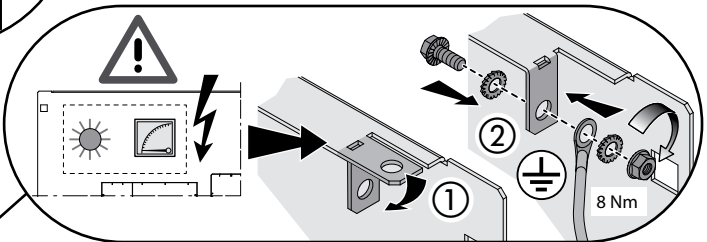
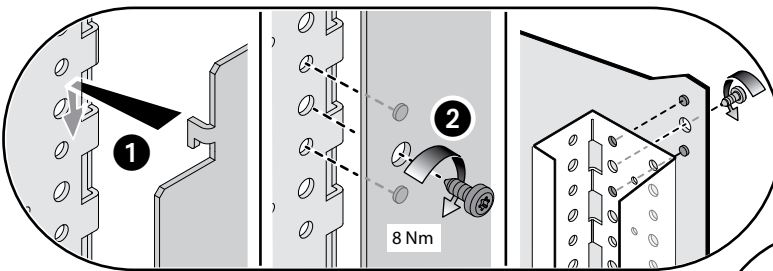
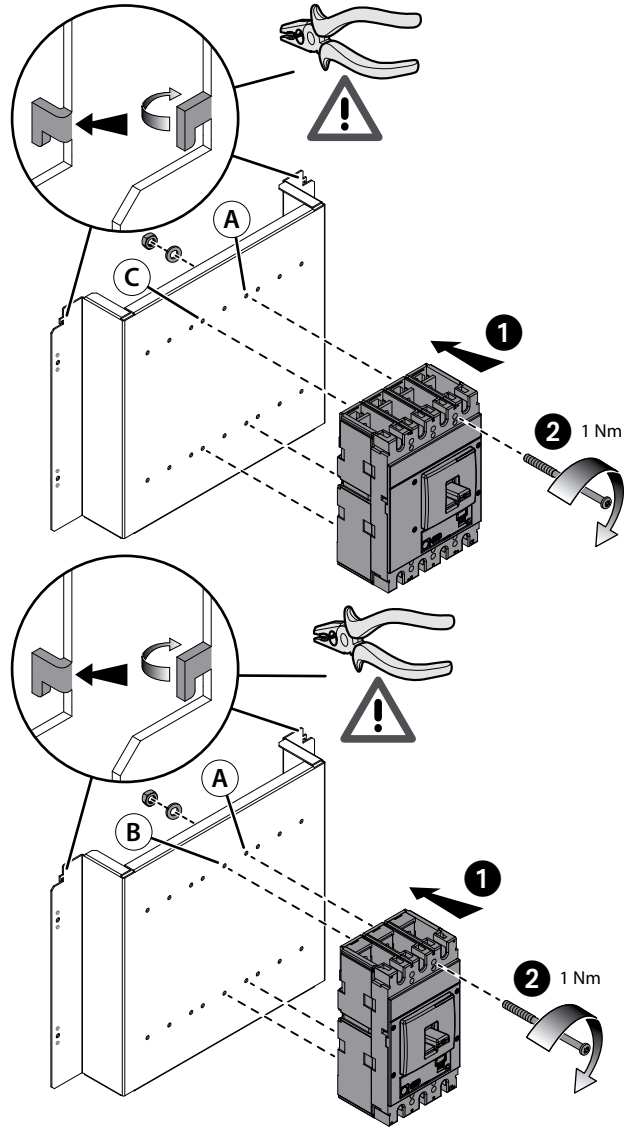
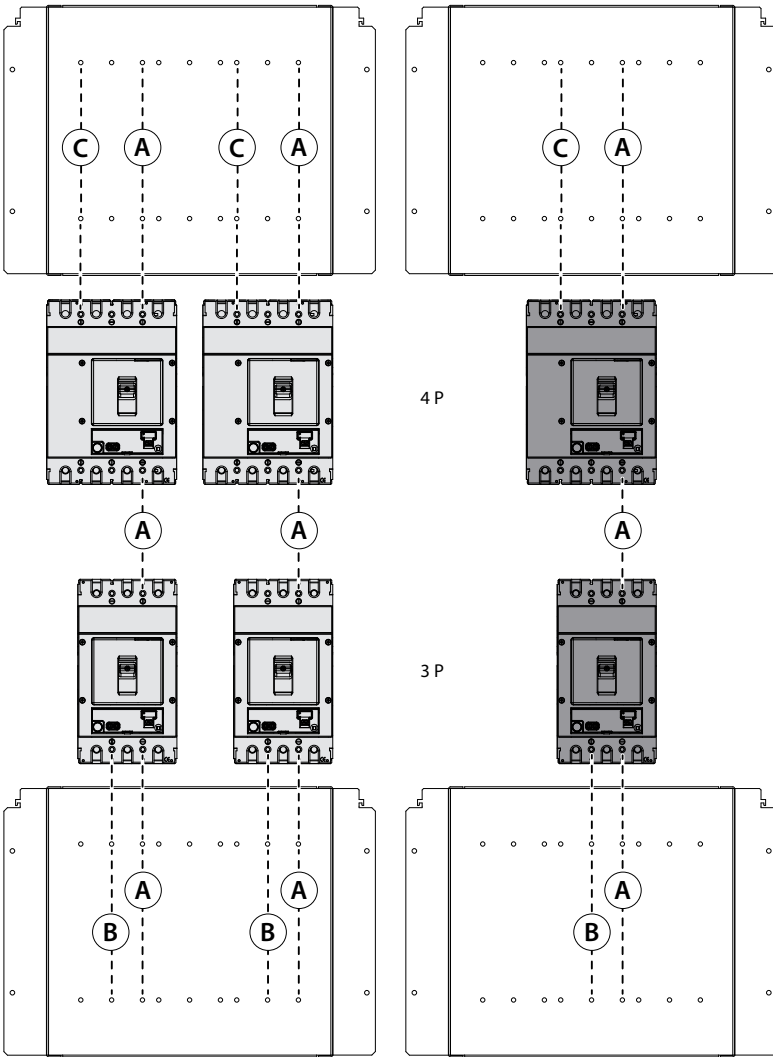







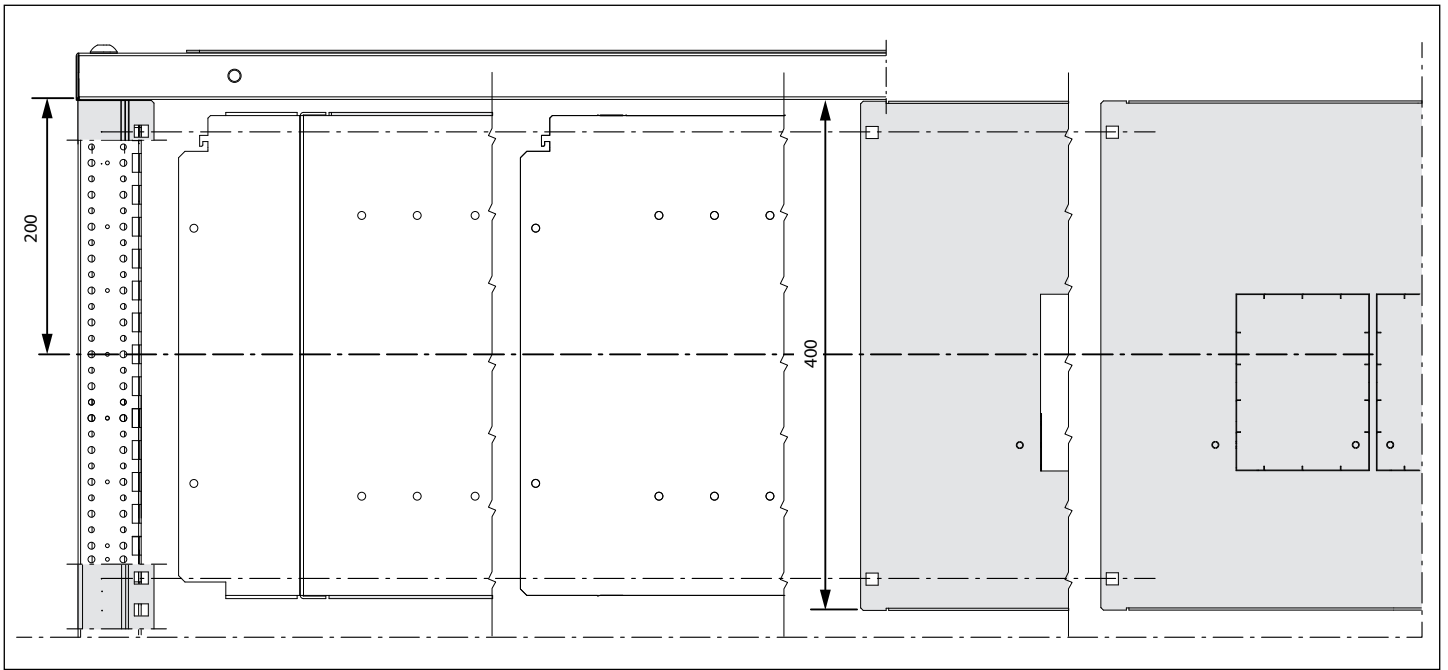

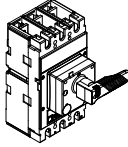

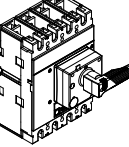
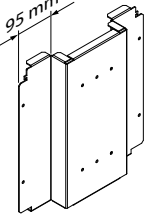
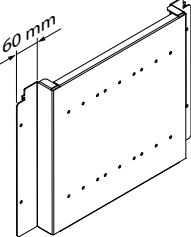
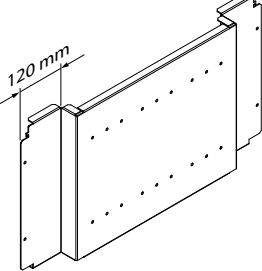
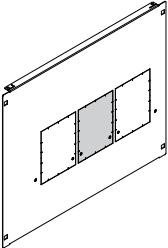
4   3 397 00/01/02

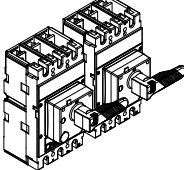

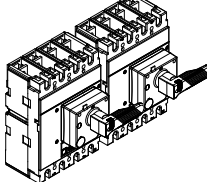
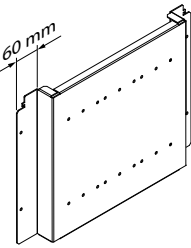
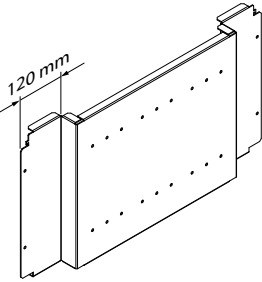
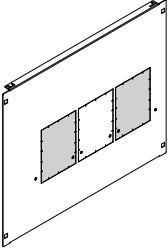

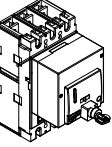

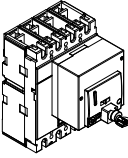
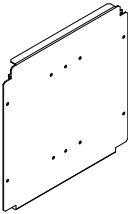
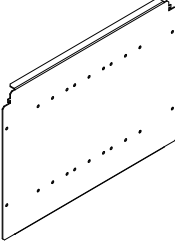
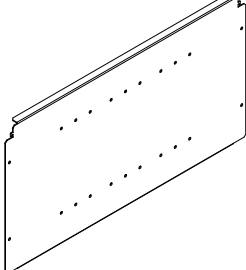
DPX³ 630		16 M	24 M	36 M	16/24/36 M
3P + MR  	4P + MR - 4P + ELCB + MR  	3 383 86 	3 383 87 	3 383 88 	3 383 92/93/94 
 	 		60 mm 	120 mm 	
3P + CM  	4P + CM - 4P + ELCB + CM  	3 383 89 	3 383 90 	3 383 91 	3 383 92/93/94 