









	29 V <sub>~</sub>
	16 mA
	4 x (Ø 0,6 mm <  < Ø 0,8 mm)
	-5°C → +45°C
	 PIR
	500 lux
	15 mn
	Auto ON/OFF
	Ø 8 m







1

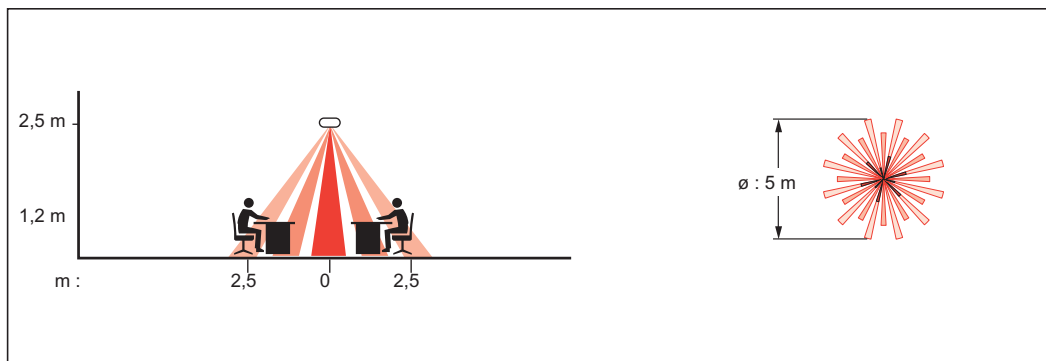
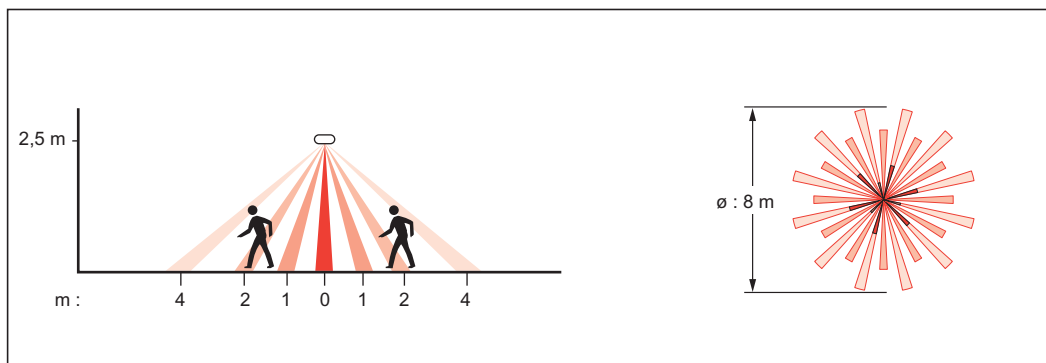
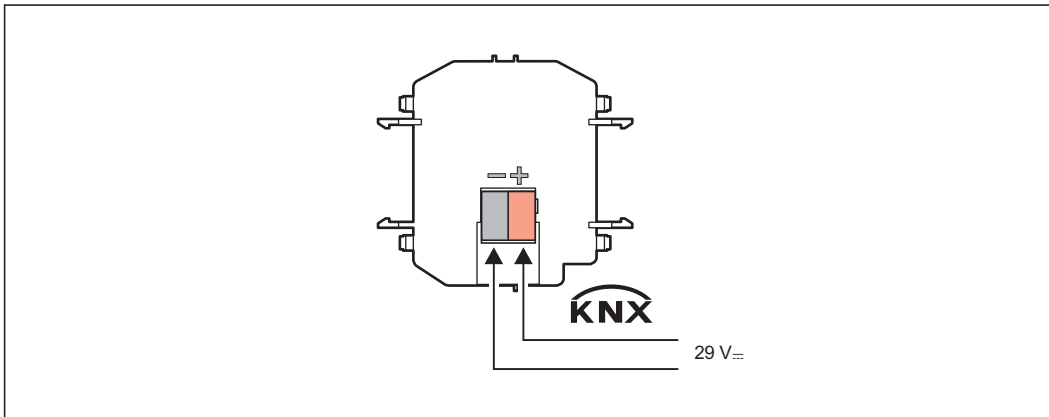
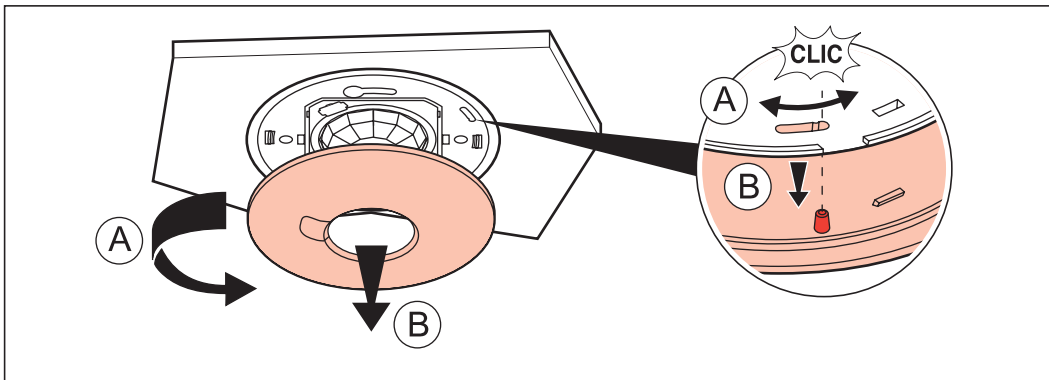
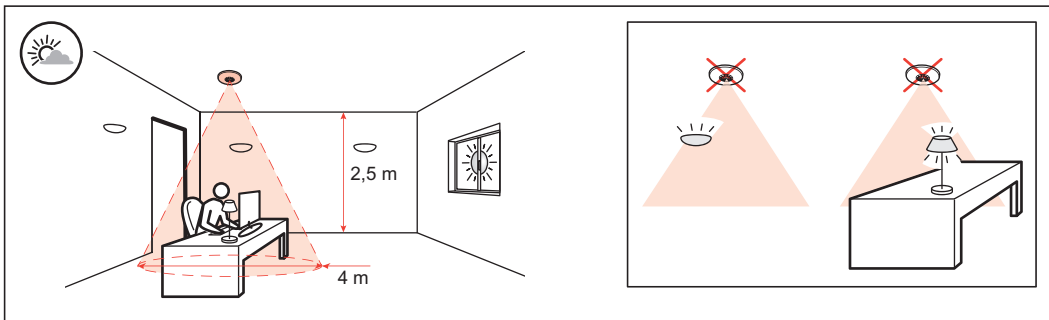
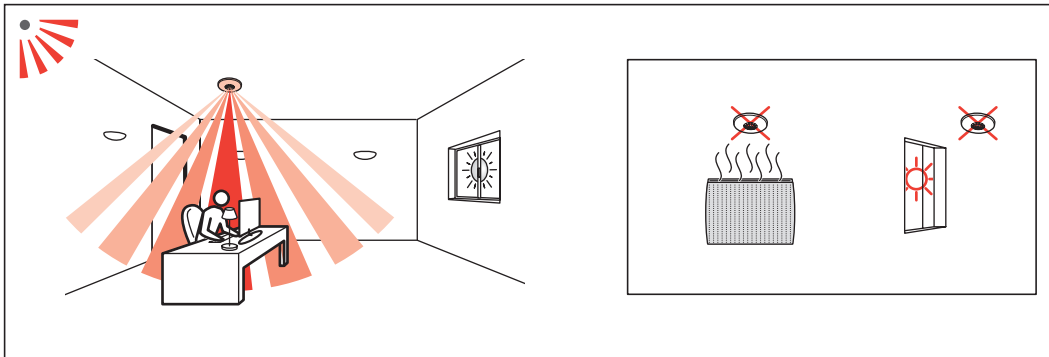
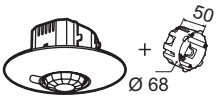
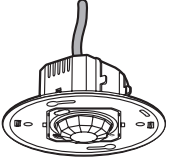

2

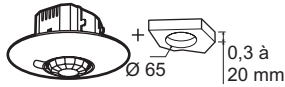
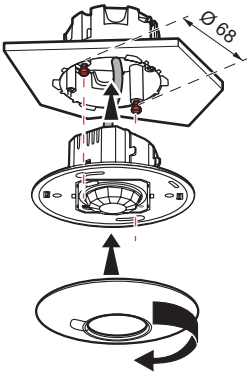

1

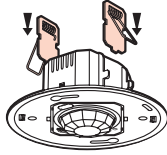

2

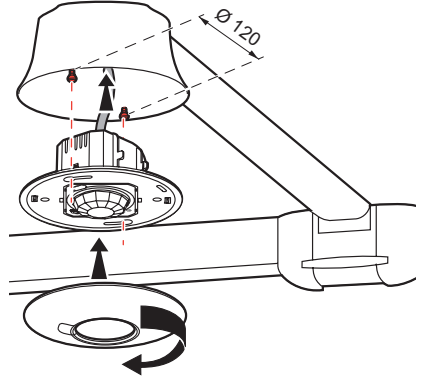
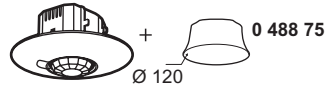
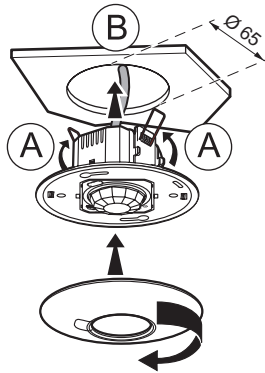



### Auto ON/OFF



### Manual ON / Auto OFF



[www.legrandoc.com](http://www.legrandoc.com)

	5 - 1275 lux
	5 sec - 17 h 59 min 59 sec
	25% - 50% - 75% - 100%
Mode	Auto ON/OFF - Manual On/Auto OFF - Walkthrough

- LED d'émission/ de réception IR
- IR reception/ transmission LED
- LED ricezione/ trasmissione IR

- LED de détection
- Presence LED
- LED rilevazione presenza

- Capteur PIR
- PIR sensor
- Sensore PIR

- Bouton de prog. KNX
- KNX prog. push-button
- Pulsante prog. KNX

- LED KNX
- KNX LED
- LED KNX

- Cellule de luminosité
- Daylight sensor
- Cellula di luminosità

- Cache de protection
- Protection
- Protezione

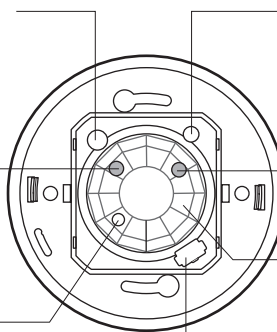

\* 0 882 30  
BMSO4001

- \* Version minimum du firmware 2.5.6, mise à jour disponible sur [www.legrandoc.com](http://www.legrandoc.com)
- Minimum version of 2.5.6 firmware update available on [www.legrandoc.com](http://www.legrandoc.com)
- Versione minima del firmware 2.5.6, software di aggiornamento disponibile su [www.legrandoc.com](http://www.legrandoc.com)

