

I-SPOT SPECIAL



PL

Oprawa I-SPOT SPECIAL jest kierunkową oprawą LED montowaną na szynoprzewodzie przeznaczoną do oświetlania żywności. Do wyboru modele zaprojektowane do oświetlania mięsa, pieczywa, ryb, serów, warzyw i owoców, alkoholi lub ubrań. Każdy model dostępny w czterech wariantach optyki (20°, 30°, 40°, 50°). Oprawa dostępna w kolorach białym i czarnym lub innym na zamówienie.

EN

I-SPOT SPECIAL directional LED lighting fitting is mounted on the busway designed for lighting of food. A choice of models designed to illuminate meat, bread, fish, cheese, vegetables and fruit, alcohol or clothes. Each model is available in four different optics (20°, 30°, 40°, 50°). The lighting fitting is available in white and black or others colours on request.

DE

Die Leuchte I-SPOT SPECIAL ist eine LED-Punktlichtquelle, die an einer Schiene zur Beleuchtung von Lebensmitteln montiert wird. Zur Wahl stehen den Kunden Leuchten für Fleischwaren, Backwaren, Fisch, Käse, Gemüse, Obst und Alkohol oder Kleidung. Jedes Modell ist in vier Optik Varianten erhältlich (20°, 30°, 40°, 50°). Die Leuchte kann in Weiß, Schwarz oder in einer anderen Farbe auf Bestellung ausgeführt werden.

OPCJE DO WYBORU / OPTIONS / OPTIONSWAHL MÖGLICH:



SC



Tc

MEAT** BREAD** FISH**
 CHEESE** VEG-FRU** ALCO-W**
 ALCO-C** CLOTHES**



20° 40°
 30° 50°



biały/white/weiß
 czarny/black/schwarz
 inny/different/andere**

SC - szyba clear hartowana/ clear tempered glass / klares gehärtetes Glas

**Opcje dostępne na zamówienie po konsultacji z działem handlowym. / Options available on request, following consultation with the sales department. / Andere Optionen auf Bestellung nach der Beratung mit der Handelsabteilung erhältlich.

PL

PARAMETRY TECHNICZNE

Sposób montażu: na szynoprzewodzie, natynkowy**
 Obudowa: ABS i aluminium
 LED: 3 elipsa MacAdama (SDCM 3)
 Napięcie zasilania: 220-240 V / 50 Hz
 Współczynnik mocy (PF): 0,99
 Poziom zakłóceń harmonicznych THD < 5%
 Klasa ochronności: I
 Stopień ochrony: IK07
 Stopień szczelności: IP40
 Temperatura otoczenia: od 0°C do +35°C
 Wilgotność otoczenia: 20-80%
 Trwałość (L70B10): 50 000 h

ZASTOSOWANIE: obiekty handlowe

EN

TECHNICAL PARAMETERS

Mounting: on track, surface mounting**
 Body: ABS and aluminium
 LED: MacAdam 3 ellipse (SDCM 3)
 Power Supply: 220-240 V / 50 Hz
 Power factor (PF): 0,99
 Harmonic distortion THD < 5%
 Protection class: I
 Protection marking: IK07
 Protection marking: IP40
 Ambient temperature: from 0°C to +35°C
 Ambient humidity: 20-80%
 Lifetime (L70B10): 50 000 h

APPLICATION: commercial buildings

DE

TECHNISCHE DATEN

Montageart: für raupen ausgelegt, zur Aufputz-Montage**
 Gehäuse: ABS und Aluminium
 LED: MacAdam 3-Ellipse (SDCM 3)
 Speisespannung: 220-240 V / 50 Hz
 Leistungsfaktor (PF): 0,99
 Harmonische Verzerrung THD < 5%
 Schutzklasse: I
 Schutzklasse: IK07
 Schutzklasse: IP40
 Umgebungstemperatur: von 0°C bis +35°C
 Umgebungsluftfeuchtigkeit: 20-80%
 Lebensdauer (L70B10): 50 000 h

EINSATZBEREICH: Handelsobjekte

Deklarowana trwałość dotyczy opraw pracujących w temperaturze otoczenia +25°C przy zapewnionych optymalnych warunkach wentylacji. / The declared lifetime applies to fixtures operating at an ambient temperature of +25°C with ensured optimal ventilation conditions. / Die erklärte Lebensdauer bezieht sich auf Leuchten, die bei einer Raumtemperatur von +25°C und optimalen Lüftungsbedingungen arbeiten.

* Spełnienie warunku UGR<19 w sensie normy PN-EN 12464-1:2012 jest wymagane dla konkretnego projektu oświetleniowego i zależy od aktualnych warunków oświetleniowych / Compliance with UGR <19 in the sense of PN-EN 12464-1: 2012 is required for a specific lighting project and depends on current lighting conditions / Die Einhaltung von UGR <19 im Sinne von PN-EN 12464-1: 2012 ist für ein bestimmtes Beleuchtungsprojekt erforderlich und hängt von den aktuellen Lichtverhältnissen ab



EAN	CODE	[W]	[K]	[°]	[lm]	[lm/W]		
-----	------	-----	-----	-----	------	--------	--	--

Typ: DALI, biała / Type: DALI, white / Art: DALI, weiß

Typ: Mięso / Type: Meat / Art: Fleisch

5902194098106	049400DMEA-SC00-0008	35	MEAT	SC	20	2000	57	DALI
5902194098113	049400DMEA-SC00-0108	35	MEAT	SC	30	2000	57	DALI
5902194098120	049400DMEA-SC00-0208	35	MEAT	SC	40	2000	57	DALI
5902194098137	049400DMEA-SC00-0308	35	MEAT	SC	50	2000	57	DALI

Typ: Pieczywo / Type: Bread / Art: Backware

5902194098144	049400DBRE-SC00-0008	35	BREAD	SC	20	2900	83	DALI
5902194098151	049400DBRE-SC00-0108	35	BREAD	SC	30	2900	83	DALI
5902194098168	049400DBRE-SC00-0208	35	BREAD	SC	40	2900	83	DALI
5902194098175	049400DBRE-SC00-0308	35	BREAD	SC	50	2900	83	DALI

Typ: Ryby / Type: Fish / Art: Fische

5902194098182	049400DFIS-SC00-0008	35	FISH	SC	20	3200	91	DALI
5902194098199	049400DFIS-SC00-0108	35	FISH	SC	30	3200	91	DALI
5902194098205	049400DFIS-SC00-0208	35	FISH	SC	40	3200	91	DALI
5902194098212	049400DFIS-SC00-0308	35	FISH	SC	50	3200	91	DALI

Typ: Sery / Type: Cheese / Art: Käse

5902194098229	049400DCHE-SC00-0008	35	CHEESE	SC	20	3000	86	DALI
5902194098236	049400DCHE-SC00-0108	35	CHEESE	SC	30	3000	86	DALI
5902194098243	049400DCHE-SC00-0208	35	CHEESE	SC	40	3000	86	DALI
5902194098250	049400DCHE-SC00-0308	35	CHEESE	SC	50	3000	86	DALI

Typ: Warzywa i owoce / Type: Vegetables and fruits / Art: Gemüse und Obst

5902194098267	049400DVEF-SC00-0008	35	VEG-FRU	SC	20	3000	86	DALI
5902194098274	049400DVEF-SC00-0108	35	VEG-FRU	SC	30	3000	86	DALI
5902194098281	049400DVEF-SC00-0208	35	VEG-FRU	SC	40	3000	86	DALI
5902194098298	049400DVEF-SC00-0308	35	VEG-FRU	SC	50	3000	86	DALI

Typ: Alkohol-biały / Type: Alcohol-white / Art: Alkohol-weiß

5902194098304	049400DALW-SC00-0008	35	ALCO-W	SC	20	3200	91	DALI
5902194098311	049400DALW-SC00-0108	35	ALCO-W	SC	30	3200	91	DALI
5902194098328	049400DALW-SC00-0208	35	ALCO-W	SC	40	3200	91	DALI
5902194098335	049400DALW-SC00-0308	35	ALCO-W	SC	50	3200	91	DALI

Typ: Alkohol-kolorowy / Type: Alcohol-colour / Art: Alkohol-farbig

5902194098342	049400DALC-SC00-0008	35	ALCO-C	SC	20	3000	86	DALI
5902194098359	049400DALC-SC00-0108	35	ALCO-C	SC	30	3000	86	DALI
5902194098366	049400DALC-SC00-0208	35	ALCO-C	SC	40	3000	86	DALI
5902194098373	049400DALC-SC00-0308	35	ALCO-C	SC	50	3000	86	DALI

Typ: Ubrania / Type: clothes / Art: Kleidung

5902194098380	049400DCLO-SC00-0008	35	CLOTHES	SC	20	3000	86	DALI
5902194098397	049400DCLO-SC00-0108	35	CLOTHES	SC	30	3000	86	DALI
5902194098403	049400DCLO-SC00-0208	35	CLOTHES	SC	40	3000	86	DALI
5902194098410	049400DCLO-SC00-0308	35	CLOTHES	SC	50	3000	86	DALI

Typ: DALI, czarna / Type: DALI, black / Art: DALI, schwarz

Typ: Mięso / Type: Meat / Art: Fleisch

5902194098427	049400DMEA-SC11-0008	35	MEAT	SC	20	2000	57	DALI
5902194098434	049400DMEA-SC11-0108	35	MEAT	SC	30	2000	57	DALI
5902194098441	049400DMEA-SC11-0208	35	MEAT	SC	40	2000	57	DALI
5902194098458	049400DMEA-SC11-0308	35	MEAT	SC	50	2000	57	DALI

Typ: Pieczywo / Type: Bread / Art: Backware

5902194098465	049400DBRE-SC11-0008	35	BREAD	SC	20	2900	83	DALI
5902194098472	049400DBRE-SC11-0108	35	BREAD	SC	30	2900	83	DALI
5902194098489	049400DBRE-SC11-0208	35	BREAD	SC	40	2900	83	DALI
5902194098496	049400DBRE-SC11-0308	35	BREAD	SC	50	2900	83	DALI

Typ: Ryby / Type: Fish / Art: Fische

5902194098502	049400DFIS-SC11-0008	35	FISH	SC	20	3200	91	DALI
5902194098519	049400DFIS-SC11-0108	35	FISH	SC	30	3200	91	DALI
5902194098526	049400DFIS-SC11-0208	35	FISH	SC	40	3200	91	DALI
5902194098533	049400DFIS-SC11-0308	35	FISH	SC	50	3200	91	DALI

Typ: Sery / Type: Cheese / Art: Käse

5902194098540	049400DCHE-SC11-0008	35	CHEESE	SC	20	3000	86	DALI
5902194098557	049400DCHE-SC11-0108	35	CHEESE	SC	30	3000	86	DALI
5902194098564	049400DCHE-SC11-0208	35	CHEESE	SC	40	3000	86	DALI
5902194098571	049400DCHE-SC11-0308	35	CHEESE	SC	50	3000	86	DALI

Typ: Warzywa i owoce / Type: Vegetables and fruits / Art: Gemüse und Obst

5902194098588	049400DVEF-SC11-0008	35	VEG-FRU	SC	20	3000	86	DALI
5902194098595	049400DVEF-SC11-0108	35	VEG-FRU	SC	30	3000	86	DALI
5902194098601	049400DVEF-SC11-0208	35	VEG-FRU	SC	40	3000	86	DALI
5902194098618	049400DVEF-SC11-0308	35	VEG-FRU	SC	50	3000	86	DALI

Typ: Alkohol-biały / Type: Alcohol-white / Art: Alkohol-weiß

5902194098625	049400DALW-SC11-0008	35	ALCO-W	SC	20	3200	91	DALI
5902194098632	049400DALW-SC11-0108	35	ALCO-W	SC	30	3200	91	DALI
5902194098649	049400DALW-SC11-0208	35	ALCO-W	SC	40	3200	91	DALI
5902194098656	049400DALW-SC11-0308	35	ALCO-W	SC	50	3200	91	DALI

Typ: Alkohol-kolorowy / Type: Alcohol-colour / Art: Alkohol-farbig

5902194098663	049400DALC-SC11-0008	35	ALCO-C	SC	20	3000	86	DALI
5902194098670	049400DALC-SC11-0108	35	ALCO-C	SC	30	3000	86	DALI
5902194098687	049400DALC-SC11-0208	35	ALCO-C	SC	40	3000	86	DALI
5902194098694	049400DALC-SC11-0308	35	ALCO-C	SC	50	3000	86	DALI

Typ: Ubrania / Type: clothes / Art: Kleidung

5902194098700	049400DCLO-SC11-0008	35	CLOTHES	SC	20	3000	86	DALI
5902194098717	049400DCLO-SC11-0108	35	CLOTHES	SC	30	3000	86	DALI
5902194098724	049400DCLO-SC11-0208	35	CLOTHES	SC	40	3000	86	DALI
5902194098731	049400DCLO-SC11-0308	35	CLOTHES	SC	50	3000	86	DALI

Całkowity strumień świetlny oprawy zmierzony za kloszem przy temp. otoczenia +25°C. Tolerancja strumienia świetlnego +/- 10%. Pomiar fotometryczny został wykonany zgodnie z wymaganiami normy PN-EN13032. / The total luminous flux of the luminaire measured diffuser +25°C. Luminous flux tolerance +/- 10%. Photometric measurement were examined in accordance with the PN-EN13032 system. / Gesamtlichtstrom der Leuchte, gemessen hinter der Abdeckung +25°C. Lichtstrom-Toleranz +/- 10%. Photometrische Messungen wurden nach PN-EN13032 Norm geprüft.

FOTOMETRIA / PHOTOMETRY / PHOTOMETRIE:

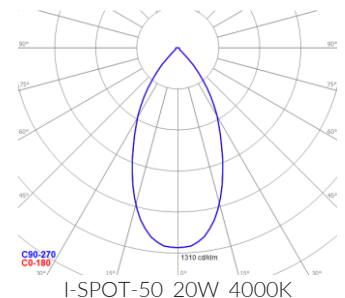
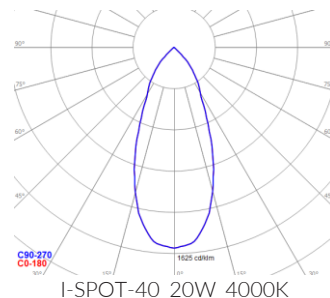
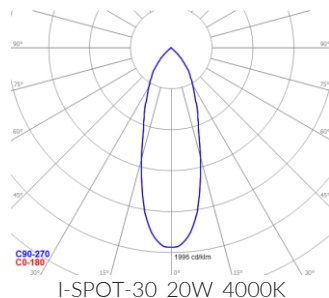
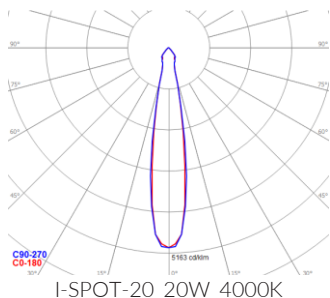

WYMIARY / DIMENSIONS / MASSE:



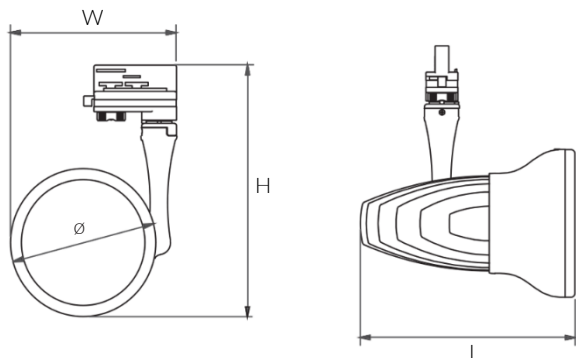



















NAME	L [mm]	W [mm]	H [mm]	∅ [mm]	[kg]
I-SPOT SPECIAL	216	166	248	146	1,0



W związku z ciągłym rozwojem produktów zastrzegamy sobie prawo do wprowadzania zmian konstrukcyjnych w oprawach oraz aktualizowania parametrów.
 Due to continuous product development, we reserve the right to introduce structural changes in the fixtures and to update their parameters.
 Aufgrund der ständigen Produktentwicklung behalten wir uns das Recht vor, technische Änderungen und Aktualisierung von Parametern an Leuchten vorzunehmen.

Data aktualizacji / Revision Date / Datum der letzten Aktualisierung: 22.11.2021

LEGENDA / LEGEND / LEGENDE:

	Deklaracja zgodności Declaration of conformity EG-Konformitätserklärung		Klasa ochronności I Protection class I Schutzklasse I		Napięcie zasilania Power supply Speisespannung
	Źródło światła LED LED source LED Quelle		Technologia stałego strumienia świetlnego Constant luminous flux technology Konstante Lichtstromtechnologie		Dyrektywa RoHS The RoHS Directive RoHS Richtlinie
	Wymiary montażowe Mounting dimensions Montagemaße		Stopień szczelności IP IP protection marking Schutzklasse IP		Atest higieniczny PZH Hygiene certificate of the NIH Attest von Polnischer Hygieneanstalt
	Kod produktu Code Artikelnummer		Rodzaj klosza Cover Abdeckung		Moc oprawy Luminaire power Leistung der Leuchte
	Kąt rozsyłu światłości Light distribution angle Winkel der Lichtverteilung		Wymiary Dimensions Masse		Temperatura barwowa Color temperature Farbtemperatur
	Strumień świetlny Luminous flux Lichtstrom		Skuteczność świetlna Luminous efficiency Lichtausbeute der Leuchte		System sterowania DALI DALI control system Steuersystem DALI
	Kolor oprawy Luminaire color Leuchte Farbe		Waga Weight Gewicht		Nazwa produktu Product name Produktname
	Wskaźnik ośnienia przykrego Glare indicator Blendungsanzeige				