

I-SPOT



PL

Oprawa I-SPOT należy do grupy kierunkowych opraw oświetlających produkty ekspozycyjne. Montaż oprawy na szynoprzewodzie. Korpus oprawy wykonany jako połączenie odlewu aluminiowego połączonego z obudową z ABS. Oprawa dostępna w standardzie w kolorach białym i czarnym. Możliwość wyboru jednego z czterech kątów rozsyłu (20°, 30°, 40° i 50°).

EN

The I-SPOT luminaire belongs to the group of directional luminaires for lighting commercial products. Mounted on busbar. The housing is made as a combination of die-cast aluminum combined with ABS housing. The luminaire in standard is available in white and black. Four beam angles to choose from (20°, 30°, 40° and 50°).

DE

Die Leuchte I-SPOT gehört zu Spotleuchten zur Beleuchtung von Ausstellungsprodukten. Montage der Leuchte am Drahtseilhalter. Das Leuchtengehäuse ist eine Verbindung vom Alu-Abguss und ABS-Gehäuse. Die Leuchte wird standardmäßig in Weiß und Schwarz angeboten. Für die Leuchte kann einer der vier Abstrahlwinkel (20°, 30°, 40° und 50°) gewählt werden.

OPCJE DO WYBORU / OPTIONS / OPTIONSWAHL MÖGLICH:



SC



2700 K
4000 K

3000 K



20° 30°
40° 50°



biały/white/weiß
czarny/black/schwarz
inny/different/andere**

SC – szyba clear hartowana/ clear tempered glass / klares gehärtetes Glas

**Opcje dostępne na zamówienie po konsultacji z działem handlowym. / Options available on request, following consultation with the sales department. / Andere Optionen auf Bestellung nach der Beratung mit der Handelsabteilung erhältlich.

PL

PARAMETRY TECHNICZNE

Sposób montażu: na szynoprzewodzie
Obudowa: ABS i aluminium
LED: 3 elipsa MacAdama (SDCM 3)
Napięcie zasilania: 220-240 V / 50 Hz
Współczynnik mocy (PF): 0,99
Poziom zakłóceń harmonicznym THD < 5%
Klasa ochronności: I
Wskaźnik oddawania barw CRI(Ra): 85 /90**
Stopień ochrony: IK07
Stopień szczelności: IP40
Temperatura otoczenia: od 0°C do +35°C
Wilgotność otoczenia: 20-80%
Trwałość (L70B10): 50 000 h

ZASTOSOWANIE: obiekty handlowe

EN

TECHNICAL PARAMETERS

Mounting: on track
Body: ABS and aluminium
LED: MacAdam 3 ellipse (SDCM 3)
Power Supply: 220-240 V / 50 Hz
Power factor (PF): 0,99
Harmonic distortion THD < 5%
Protection class: I
Color rendering index CRI(Ra): 85 /90**
Protection marking: IK07
Protection marking: IP40
Ambient temperature: from 0°C to +35°C
Ambient humidity: 20-80%
Lifetime (L70B10): 50 000 h

APPLICATION: commercial buildings

DE

TECHNISCHE DATEN

Montageart: für raupen ausgelegt
Gehäuse: ABS und Aluminium
LED: MacAdam 3-Ellipse (SDCM 3)
Speisespannung: 220-240 V / 50 Hz
Leistungsfaktor (PF): 0,99
Harmonische Verzerrung THD < 5%
Schutzklasse: I
Farbwiedergabe Faktor CRI(Ra): 85 /90**
Schutzklasse: IK07
Schutzklasse: IP40
Umgebungstemperatur: von 0°C bis +35°C
Umgebungsluftfeuchtigkeit: 20-80%
Lebensdauer (L70B10): 50 000 h

EINSATZBEREICH: Handelsobjekte

Deklarowana trwałość dotyczy opraw pracujących w temperaturze otoczenia +25°C przy zapewnionych optymalnych warunkach wentylacji. / The declared lifetime applies to fixtures operating at an ambient temperature of +25°C with ensured optimal ventilation conditions. / Die erklärte Lebensdauer bezieht sich auf Leuchten, die bei einer Raumtemperatur von +25°C und optimalen Lüftungsbedingungen arbeiten.

* Spełnienie warunku UGR<19 w sensie normy PN-EN 12464-1:2012 jest wymagane dla konkretnego projektu oświetleniowego i zależy od aktualnych warunków oświetleniowych / Compliance with UGR <19 in the sense of PN-EN 12464-1: 2012 is required for a specific lighting project and depends on current lighting conditions / Die Einhaltung von UGR <19 im Sinne von PN-EN 12464-1: 2012 ist für ein bestimmtes Beleuchtungsprojekt erforderlich und hängt von den aktuellen Lichtverhältnissen ab



EAN	CODE	[W]	[K]	[°]	[lm]	[lm/W]		
Typ: DALI, 4000K, biała / Type: DALI, 4000K, white / Art: DALI, 4000K, weiß								
5902194098748	029400D840-SC00-0003	20	4000	SC	20	2100	105	DALI
5902194098755	029400D840-SC00-0103	20	4000	SC	30	2350	118	DALI
5902194098762	029400D840-SC00-0203	20	4000	SC	40	2350	118	DALI
5902194098779	029400D840-SC00-0303	20	4000	SC	50	2350	118	DALI
5902194098786	029400D840-SC00-0006	30	4000	SC	20	2900	97	DALI
5902194098793	029400D840-SC00-0106	30	4000	SC	30	3200	107	DALI
5902194098809	029400D840-SC00-0206	30	4000	SC	40	3200	107	DALI
5902194098816	029400D840-SC00-0306	30	4000	SC	50	3200	107	DALI
5902194098823	029400D840-SC00-0008	35	4000	SC	20	3200	91	DALI
5902194098830	029400D840-SC00-0108	35	4000	SC	30	3550	101	DALI
5902194098847	029400D840-SC00-0208	35	4000	SC	40	3550	101	DALI
5902194098854	029400D840-SC00-0308	35	4000	SC	50	3550	101	DALI
Typ: DALI, 3000K, biała / Type: DALI, 3000K, white / Art: DALI, 3000K, weiß								
5902194098861	029400D830-SC00-0003	20	3000	SC	20	2000	100	DALI
5902194098878	029400D830-SC00-0103	20	3000	SC	30	2200	110	DALI
5902194098885	029400D830-SC00-0203	20	3000	SC	40	2200	110	DALI
5902194098892	029400D830-SC00-0303	20	3000	SC	50	2200	110	DALI
5902194098908	029400D830-SC00-0006	30	3000	SC	20	2750	92	DALI
5902194098915	029400D830-SC00-0106	30	3000	SC	30	3000	100	DALI
5902194098922	029400D830-SC00-0206	30	3000	SC	40	3000	100	DALI
5902194098939	029400D830-SC00-0306	30	3000	SC	50	3000	100	DALI
5902194098946	029400D830-SC00-0008	35	3000	SC	20	3000	86	DALI
5902194098953	029400D830-SC00-0108	35	3000	SC	30	3350	96	DALI
5902194098960	029400D830-SC00-0208	35	3000	SC	40	3350	96	DALI
5902194098977	029400D830-SC00-0308	35	3000	SC	50	3350	96	DALI
Typ: DALI, 2700K, biała / Type: DALI, 2700K, white / Art: DALI, 2700K, weiß								
5902194098984	029400D827-SC00-0003	20	2700	SC	20	2000	100	DALI
5902194098991	029400D827-SC00-0103	20	2700	SC	30	2200	110	DALI
5902194099004	029400D827-SC00-0203	20	2700	SC	40	2200	110	DALI
5902194099011	029400D827-SC00-0303	20	2700	SC	50	2200	110	DALI
5902194099028	029400D827-SC00-0006	30	2700	SC	20	2750	92	DALI
5902194099035	029400D827-SC00-0106	30	2700	SC	30	3000	100	DALI
5902194099042	029400D827-SC00-0206	30	2700	SC	40	3000	100	DALI
5902194099059	029400D827-SC00-0306	30	2700	SC	50	3000	100	DALI
5902194099066	029400D827-SC00-0008	35	2700	SC	20	3000	86	DALI
5902194099073	029400D827-SC00-0108	35	2700	SC	30	3350	96	DALI
5902194099080	029400D827-SC00-0208	35	2700	SC	40	3350	96	DALI
5902194099097	029400D827-SC00-0308	35	2700	SC	50	3350	96	DALI
Typ: DALI, 4000K, czarna / Type: DALI, 4000K, black / Art: DALI, 4000K, schwarz								
5902194099103	029400D840-SC11-0003	20	4000	SC	20	2100	105	DALI
5902194099110	029400D840-SC11-0103	20	4000	SC	30	2350	118	DALI
5902194099127	029400D840-SC11-0203	20	4000	SC	40	2350	118	DALI
5902194099134	029400D840-SC11-0303	20	4000	SC	50	2350	118	DALI
5902194099141	029400D840-SC11-0006	30	4000	SC	20	2900	97	DALI
5902194099158	029400D840-SC11-0106	30	4000	SC	30	3200	107	DALI
5902194099165	029400D840-SC11-0206	30	4000	SC	40	3200	107	DALI
5902194099172	029400D840-SC11-0306	30	4000	SC	50	3200	107	DALI

5902194099189	029400D840-SC11-0008	35	4000	SC	20	3200	91	DALI
5902194099196	029400D840-SC11-0108	35	4000	SC	30	3550	101	DALI
5902194099202	029400D840-SC11-0208	35	4000	SC	40	3550	101	DALI
5902194099219	029400D840-SC11-0308	35	4000	SC	50	3550	101	DALI
Typ: DALI, 3000K, czarna / Type: DALI, 3000K, black / Art: DALI, 3000K, schwarz								
5902194099226	029400D830-SC11-0003	20	3000	SC	20	2000	100	DALI
5902194099233	029400D830-SC11-0103	20	3000	SC	30	2200	110	DALI
5902194099240	029400D830-SC11-0203	20	3000	SC	40	2200	110	DALI
5902194099257	029400D830-SC11-0303	20	3000	SC	50	2200	110	DALI
5902194099264	029400D830-SC11-0006	30	3000	SC	20	2750	92	DALI
5902194099271	029400D830-SC11-0106	30	3000	SC	30	3000	100	DALI
5902194099288	029400D830-SC11-0206	30	3000	SC	40	3000	100	DALI
5902194099295	029400D830-SC11-0306	30	3000	SC	50	3000	100	DALI
5902194099301	029400D830-SC11-0008	35	3000	SC	20	3000	86	DALI
5902194099318	029400D830-SC11-0108	35	3000	SC	30	3350	96	DALI
5902194099325	029400D830-SC11-0208	35	3000	SC	40	3350	96	DALI
5902194099332	029400D830-SC11-0308	35	3000	SC	50	3350	96	DALI
Typ: DALI, 2700K, czarna / Type: DALI, 2700K, black / Art: DALI, 2700K, schwarz								
5902194099349	029400D827-SC11-0003	20	2700	SC	20	2000	100	DALI
5902194099356	029400D827-SC11-0103	20	2700	SC	30	2200	110	DALI
5902194099363	029400D827-SC11-0203	20	2700	SC	40	2200	110	DALI
5902194099370	029400D827-SC11-0303	20	2700	SC	50	2200	110	DALI
5902194099387	029400D827-SC11-0006	30	2700	SC	20	2750	92	DALI
5902194099394	029400D827-SC11-0106	30	2700	SC	30	3000	100	DALI
5902194099400	029400D827-SC11-0206	30	2700	SC	40	3000	100	DALI
5902194099417	029400D827-SC11-0306	30	2700	SC	50	3000	100	DALI
5902194099424	029400D827-SC11-0008	35	2700	SC	20	3000	86	DALI
5902194099431	029400D827-SC11-0108	35	2700	SC	30	3350	96	DALI
5902194099448	029400D827-SC11-0208	35	2700	SC	40	3350	96	DALI
5902194099455	029400D827-SC11-0308	35	2700	SC	50	3350	96	DALI

Całkowity strumień świetlny oprawy zmierzony za kloszem przy temp. otoczenia +25°C. Tolerancja strumienia świetlnego +/- 10%. Pomiary fotometryczne zostały wykonane zgodnie z wymaganiami normy PN-EN13032. / The total luminous flux of the luminaire measured diffuser +25°C. Luminous flux tolerance +/- 10%. Photometric measurement were examined in accordance with the PN-EN13032 system. / Gesamtlichtstrom der Leuchte, gemessen hinter der Abdeckung +25°C. Lichtstrom-Toleranz +/- 10%. Photometrische Messungen wurden nach PN-EN13032 Norm geprüft.

FOTOMETRIA / PHOTOMETRY / PHOTOMETRIE:

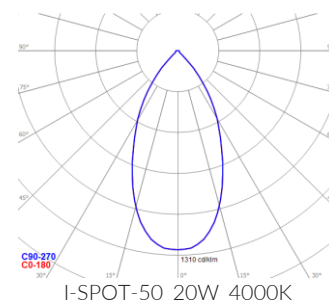
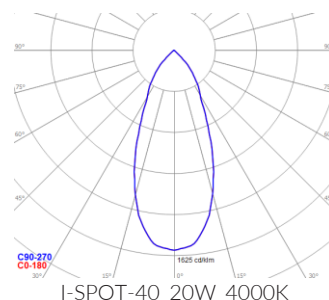
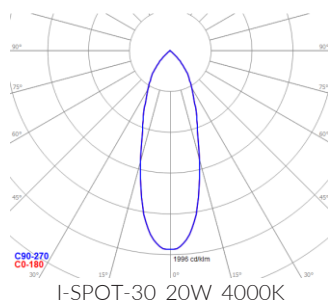
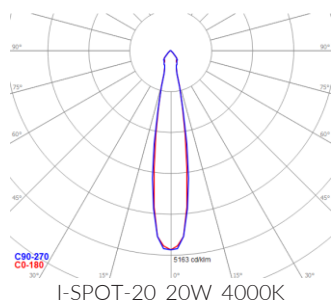

WYMIARY / DIMENSIONS / MASSE:



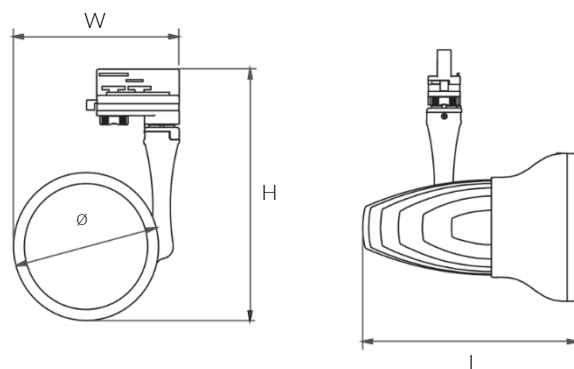



















NAME	L [mm]	W [mm]	H [mm]	∅ [mm]	[kg]
I-SPOT	216	166	248	146	1,0



W związku z ciągłym rozwojem produktów zastrzegamy sobie prawo do wprowadzania zmian konstrukcyjnych w oprawach oraz aktualizowania parametrów.
 Due to continuous product development, we reserve the right to introduce structural changes in the fixtures and to update their parameters.
 Aufgrund der ständigen Produktentwicklung behalten wir uns das Recht vor, technische Änderungen und Aktualisierung von Parametern an Leuchten vorzunehmen.

Data aktualizacji / Revision Date / Datum der letzten Aktualisierung: 30.11.2021

LEGENDA / LEGEND / LEGENDE:

	Deklaracja zgodności Declaration of conformity EG-Konformitätserklärung		Klasa ochronności I Protection class I Schutzklasse I		Napięcie zasilania Power supply Speisespannung
	Źródło światła LED LED source LED Quelle		Technologia stałego strumienia świetlnego Constant luminous flux technology Konstante Lichtstromtechnologie		Dyrektywa RoHS The RoHS Directive RoHS Richtlinie
	Wymiary montażowe Mounting dimensions Montagemaße		Stopień szczelności IP IP protection marking Schutzklasse IP		Atest higieniczny PZH Hygiene certificate of the NIH Attest von Polnischer Hygieneanstalt
	Kod produktu Code Artikelnummer		Rodzaj klosza Cover Abdeckung		Moc oprawy Luminaire power Leistung der Leuchte
	Kąt rozsyłu światłości Light distribution angle Winkel der Lichtverteilung		Wymiary Dimensions Masse		Temperatura barwowa Color temperature Farbtemperatur
	Strumień świetlny Luminous flux Lichtstrom		Skuteczność świetlna Luminous efficiency Lichtausbeute der Leuchte		System sterowania DALI DALI control system Steuersystem DALI
	Kolor oprawy Luminaire color Leuchte Farbe		Waga Weight Gewicht		Nazwa produktu Product name Produktname
	Wskaźnik ośnienia przykrego Glare indicator Blendungsanzeige				