

Plexo™ TV/R/SAT (DAB+) sockets

Cat. No(s): 0 695 54L - 0 695 58L
 0 696 54L - 0 698 58L

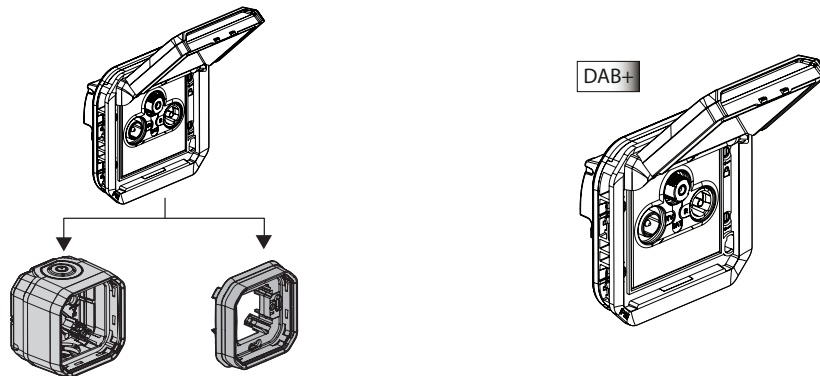

1. USE

Waterproof equipment system intended for residential and professional technical locations (garages, cellars, car parks, workshops and industrial kitchens, etc.) as well as outdoor environments (terraces, gardens, campsites, etc.).

TV/R/SAT: allows reception of TV, Radio and Satellite signals.

Compatible with UHD (Ultra High Definition) television and DAB+ radio (Digital Audio Broadcasting).

Class A shielded star plug, 4G LTE compatible.

Recommended cable 17/19 VATC.

2. RANGE

	References: Designations
Configurable 	0 695 54L - 0 695 58L 0 696 54L - 0 698 58L

3. OVERALL DIMENSIONS (mm)

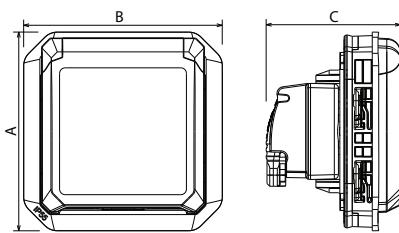

	A	B	C	D
Configurable	70.5	70.5	47.7	-

4. CONNECTION

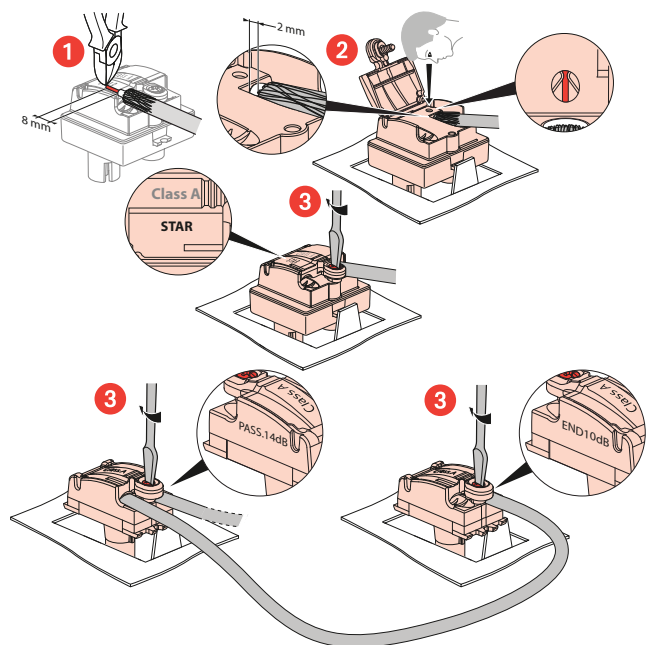

5. WIRING PRECAUTIONS

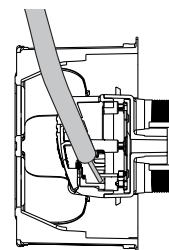
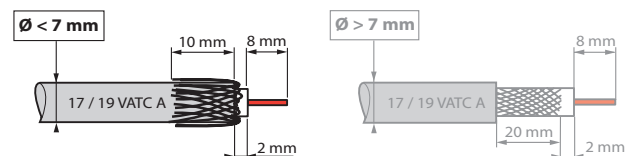

Connection from the rear of the socket reduces deformation of the coaxial cable, thus avoiding the risk of impedance loss and impaired performance.

6. TECHNICAL CHARACTERISTICS

■ 6.1 Mechanical characteristics

Protection against solid bodies and liquids: IP 55
 Protection against impacts: IK 07
 Cable resistance: 120 N: standard IEC 61169-24

■ 6.2 Material characteristics

Material: Cover-plate: ABS
 Mechanism casing: PC
 Support: PC
 Claws: Steel

Halogen-free
 UV-resistant

Motor: - Box: Zamac
 - Cover: Zamac
 - Pin: Bronze
 - Screws: Steel

Self-extinguishing: 650°C/30 s

■ 6.3 Electrical characteristics

- Impedance: 75 Ohm
- Male connector Ø 9.52 mm (TV)
- Class A shielding efficiency (class A shielding is necessary to prevent interference caused by using new 3 and 4 G phone signals, as these unwanted signals can result in pixellation on screen or adversely affect the sound track).
- Frequency bands: TV : 5-68 / 320-862 MHz
 R : 87,5-240 MHz
 SAT : 950-2400 MHz

UHD : passage des signaux d'amélioration :
 WCG : Wide Color Gamut
 HDR : High Dynamic Range
 HFR : High Frame Rate

DAB+ : AAC+ codec pass defined in the MPEG-4 part3 standard

- Low attenuation: <1.5 dB

Insulation resistance: standard IEC 61169-24

■ 6.4 Climate characteristics

Storage temperature : -10°C to +70°C
 Use temperature: -5°C to +40°C

7. MAINTENANCE

Surface cleaning with a cloth.
 Do not use: acetone, tar remover, trichloroethylene.

Maintenance with the following products: Hexane (EN 60669-1), Methylated spirit, Soapy water, Diluted ammonia, Bleach diluted to 10%, Window-cleaning products.

Caution: Always test before using other special cleaning products.

8. STANDARDS AND APPROVALS

Compliant with installation and manufacturing standards
 Refer to e. catalogue.

9. PERFORMANCE

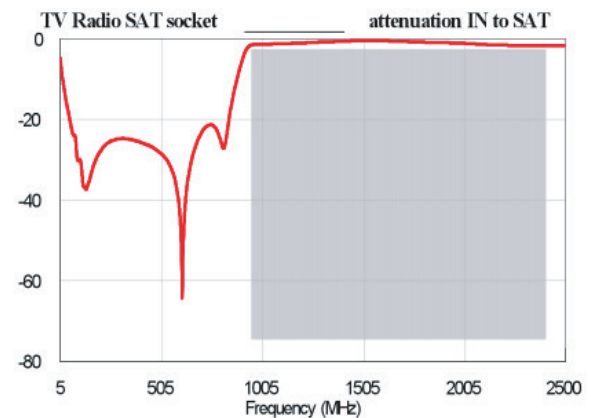
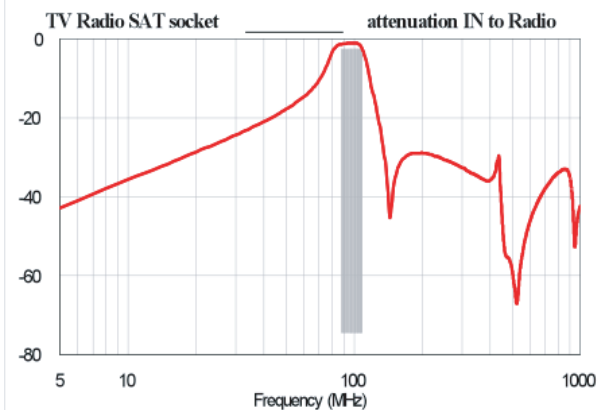
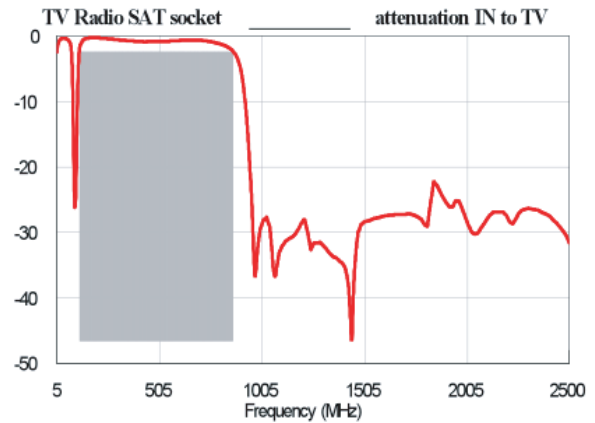

Prises TV Radio DAB

