

## LCS2 Cat. 6A RJ 45

Cat. No(s): 0 331 54/55

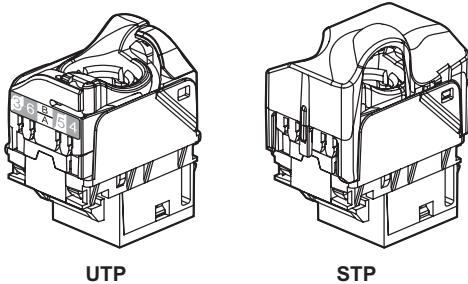

### CONTENTS



Page

1. General characteristics . . . . .	1
2. Presentation . . . . .	1
3. Technical characteristics . . . . .	1
4. Overall dimensions . . . . .	2
5. Usual connection of RJ45 sockets . . . . .	2-3
6. Standards and approvals . . . . .	3
7. Performance . . . . .	3-6

### 1. GENERAL CHARACTERISTICS

Cat. 6A RJ 45 terminal socket for high speed connection to a network.  
Enables data transmission at 10 Gbit/s.  
Socket is used with F/UTP or S/FTP cables.

### 2. PRESENTATION

Référence	Désignation	UTP 	STP 
0 331 55	Keystone RJ45 UTP socket cat.6A	SK61	
0 331 54	Keystone RJ45 STP socket cat.6A		SK63

### 3. TECHNICAL CHARACTERISTICS

#### 3.1 Material characteristics

Contacts: gold/nickel, minimum thickness of gold > 0.8 µm  
Metal parts: bronze, nickel, platinum, gold  
PBT polycarbonate  
For STP products the body and the spreader are made of metal alloy with a copper-nickel coating.

#### 3.2 Electrical characteristics

Breakdown voltage ≥ 1000 V  
Contact resistance ≤ 20 mΩ  
Insulation resistance ≥ 500 MΩ at 100 V DC  
Connector tested and guaranteed under PoE restrictions, IEEE 802.3af standard and PoE+, draft standard 802.3at, up to 2500 on-load connections / disconnections.

Tests are carried out with 2 simultaneous PoE+ circuits for a minimum total power of 50 W.

#### 3.3 Mechanical characteristics

Max. number of connections and disconnections: 5 without refreshing the wiring.  
Endurance: 2500 movements (plug insertion/withdrawal)  
IK03

#### 3.4 Climatic characteristics

Operating temperature: - 40° C to + 70° C  
Humid heat cycle 21 days

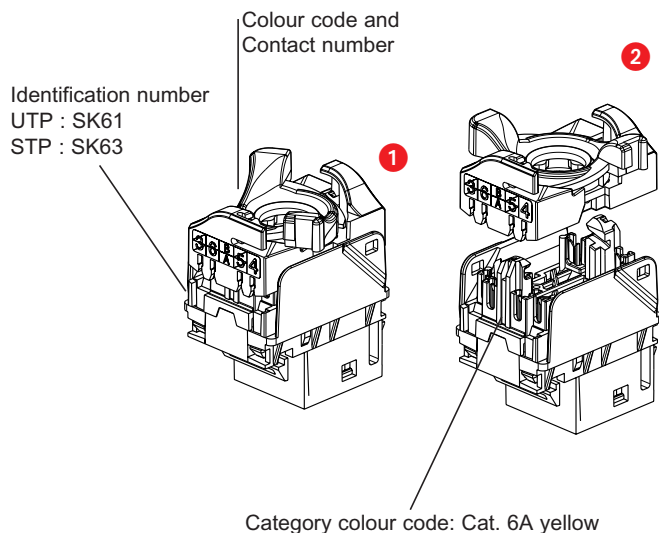

4. OVERALL DIMENSIONS

0 331 55

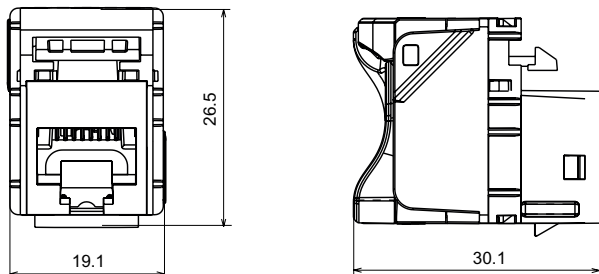

0 331 54

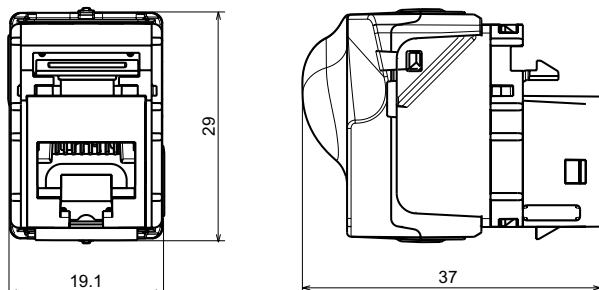

5. USUAL CONNECTION OF RJ 45S

Accepts the following cable connectors:  
 RJ11 (4 contacts), RJ12 (6 contacts), RJ45 (9 contacts).  
 Double colour code EIA – TIA 568 A and B on terminals:  
 - STP 9 contacts 360° screen

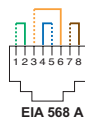

EIA 568 A



EIA 568 B



Conductors supported:

- Single-wire: 0.5 to 0.65 mm, AWG 22 to 25
- Multiple-wire: AWG 26
- Polyethylene conductor insulation: max Ø with insulation 1.58 mm.

RJ 45 connectors are equipped with a locking nut that does not require the use of a specific tool and which enables re-cabling in the event of error.

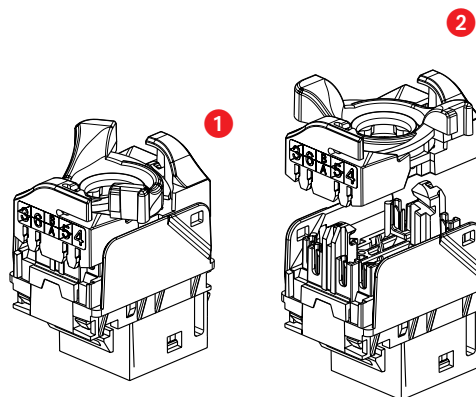

**5. USUAL CONNECTION OF RJ 45S (cont.)**

This system allows the wire pairs to be spread easily before mounting them on the connector.

Spreading cables ensures that each pair is separated by the specified 13 mm.

Spreading pairs by 90° in relation to the cable ensures optimum performance.

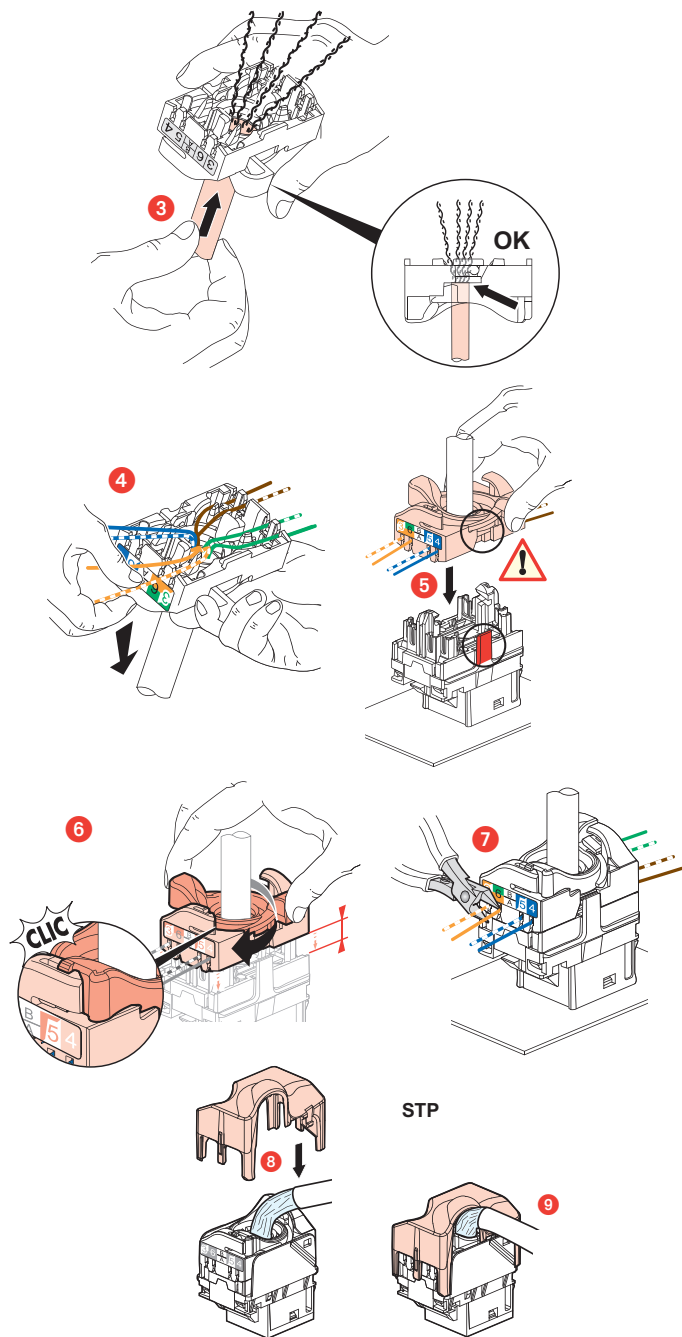

**6. STANDARDS AND APPROVALS**

Compliant with standards: ISO 11801 Second edition, amd. 2  
 EN 50173 Second edition  
 EIA/TIA-568-C.2  
 NF C 20730  
 Standard 8877 - 603.7  
 60603-7 Ed. 3 (Keystone standard)

**7. PERFORMANCE**

**7.1 Performance of permanent link with F/UTP cable**

Return loss

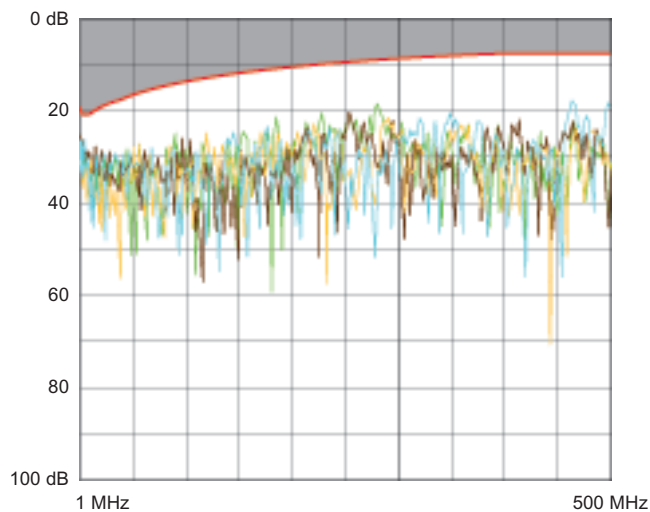

Attenuation

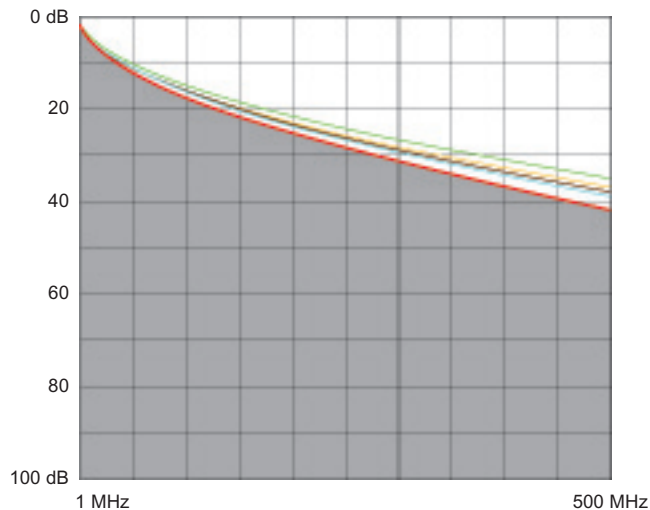

NEXT (Near end Crosstalk Attenuation)

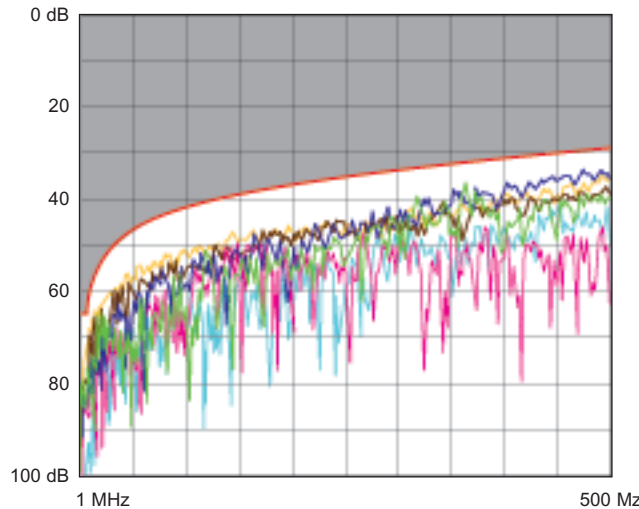

7. PERFORMANCE (cont.)

7.1 Performance of permanent link with F/UTP cable (cont.)  
PS NEXT (Power Sum NEXT)

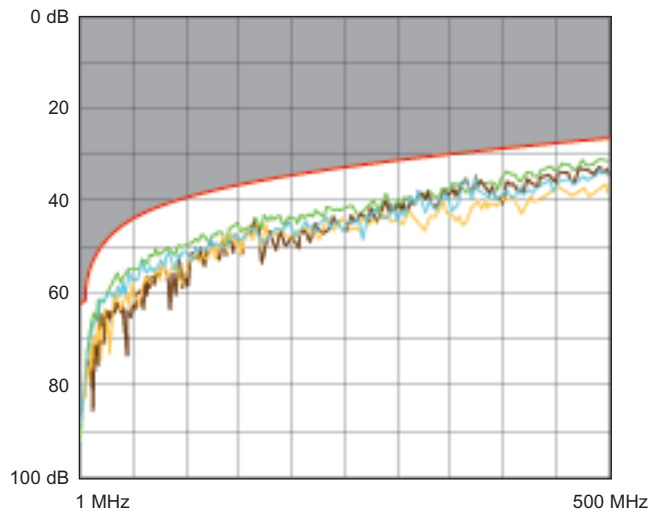

ACR (Attenuation to Crosstalk Ratio)

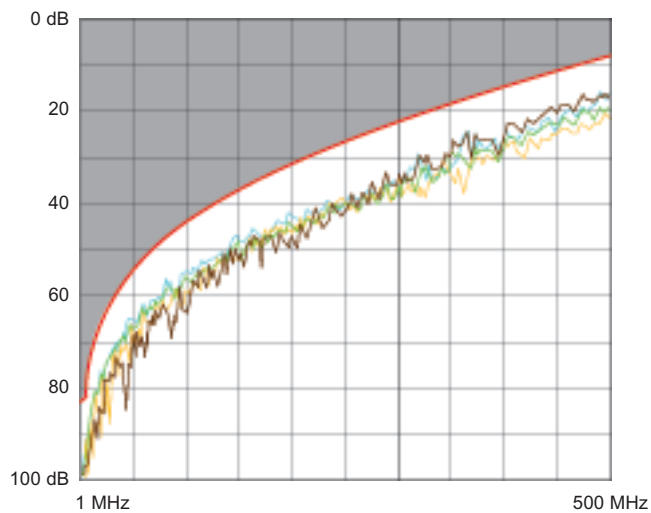

ELFEXT (Equal Level End Crosstalk Attenuation)

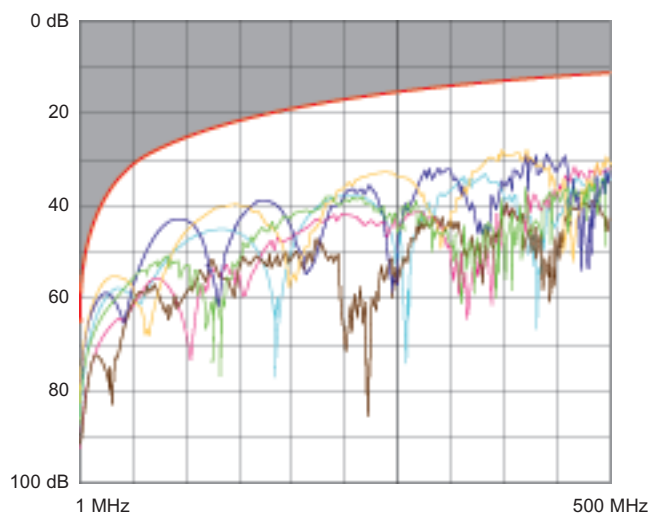

7. PERFORMANCE (cont.)

7.1 Performance of permanent link with F/UTP cable (cont.)  
Delay skew

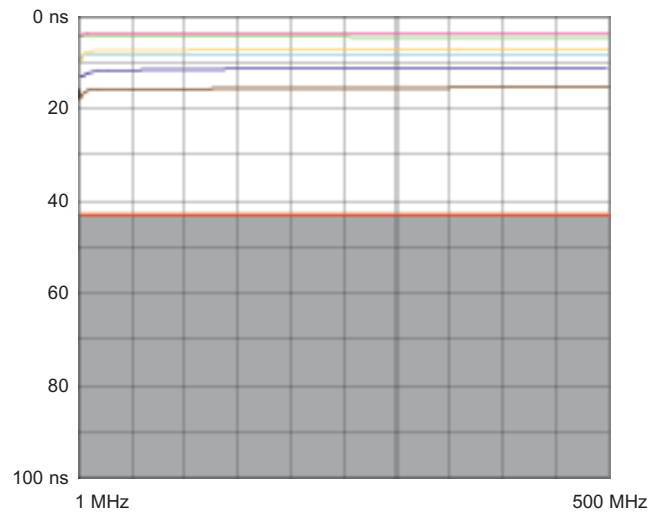

7.2 Performance of permanent link with S/FTP cable  
Return loss

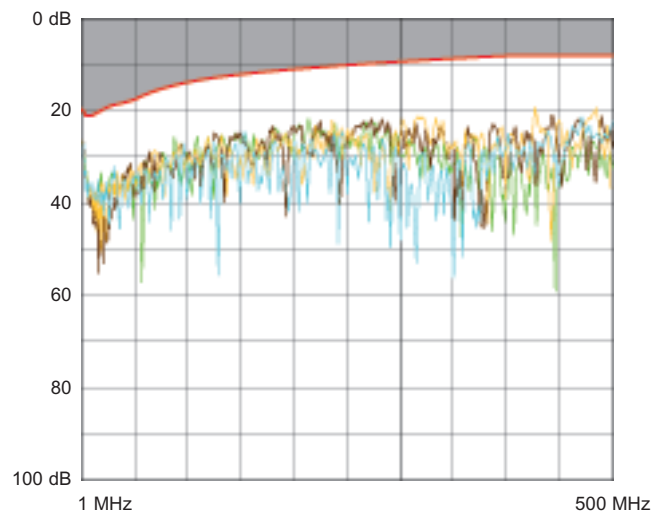

Attenuation

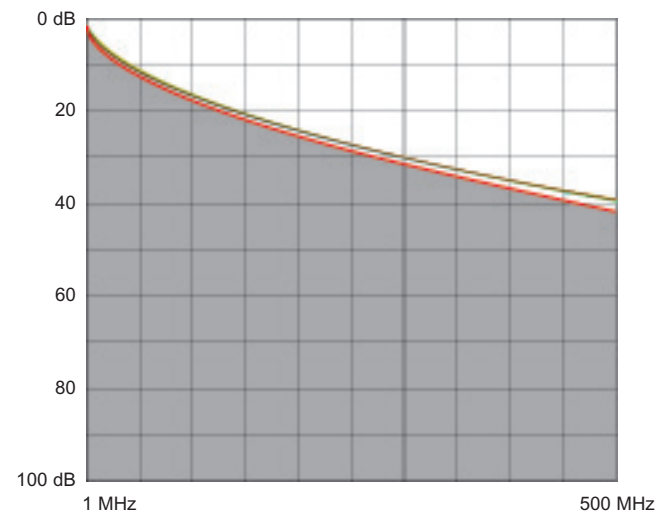

7. PERFORMANCE (cont.)

7.2 Performance of permanent link with S/FTP cable (cont.)  
NEXT (Near end Crosstalk Attenuation)

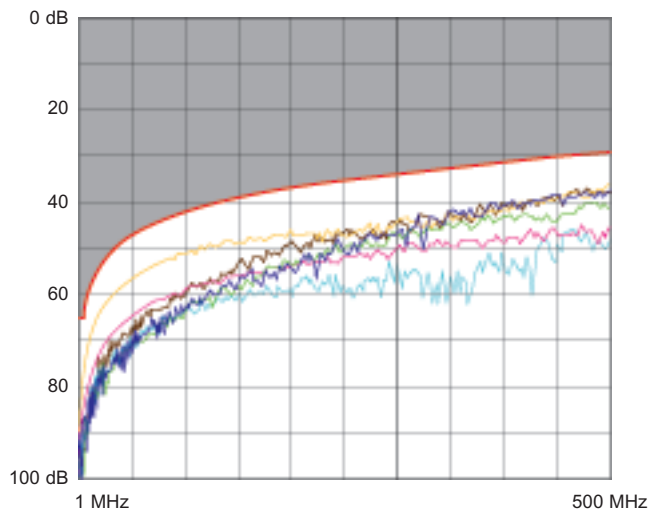

PS NEXT (Power Sum NEXT)

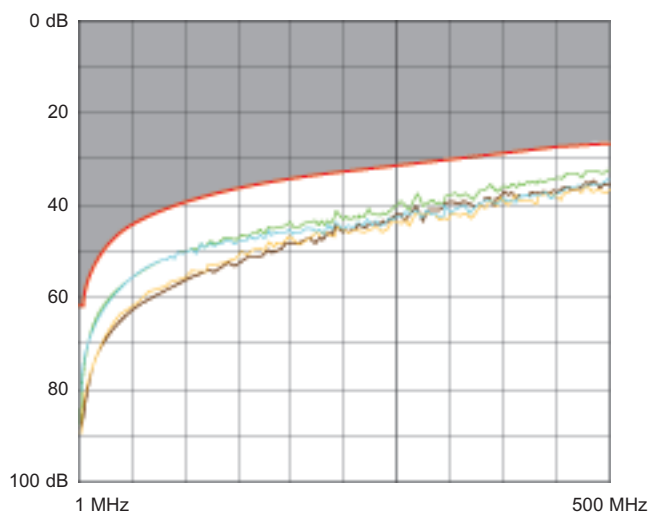

ACR (Attenuation to Crosstalk Ratio)

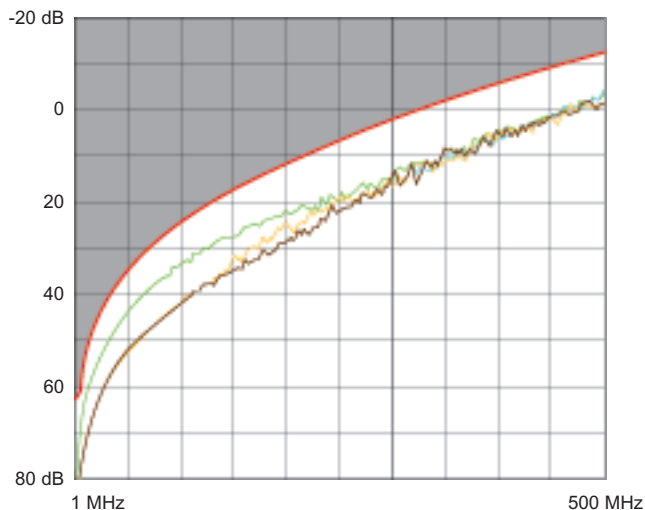

7. PERFORMANCE (cont.)

7.2 Performance of permanent link with S/FTP cable (cont.)  
ELFEXT (Equal Level End Crosstalk Attenuation)

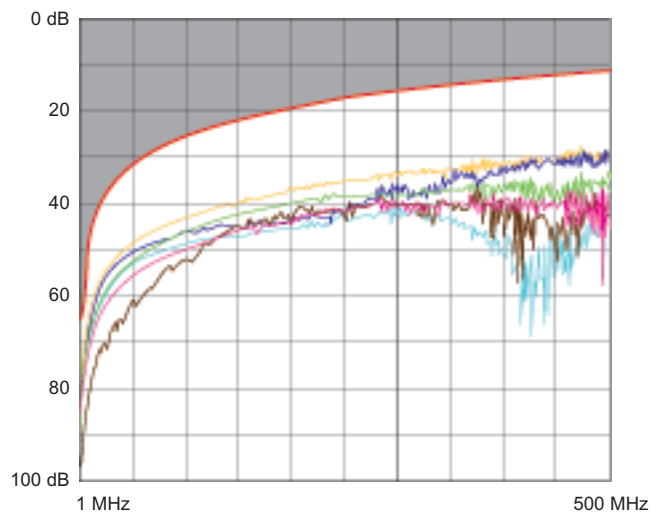

Delay skew

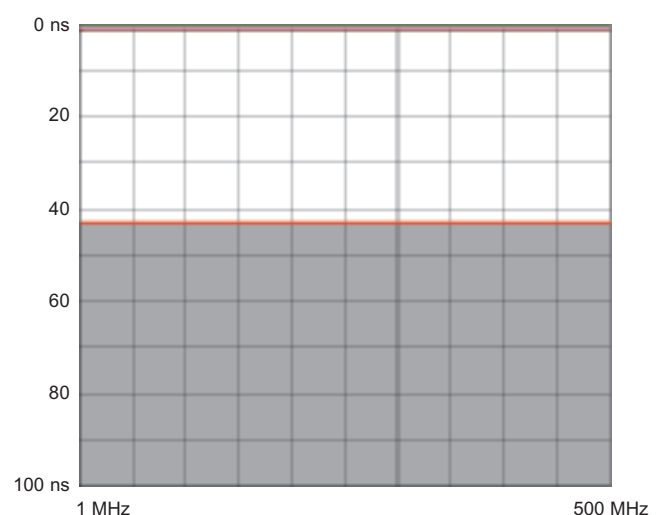

7.3 Performances canal (Channel)

Return loss

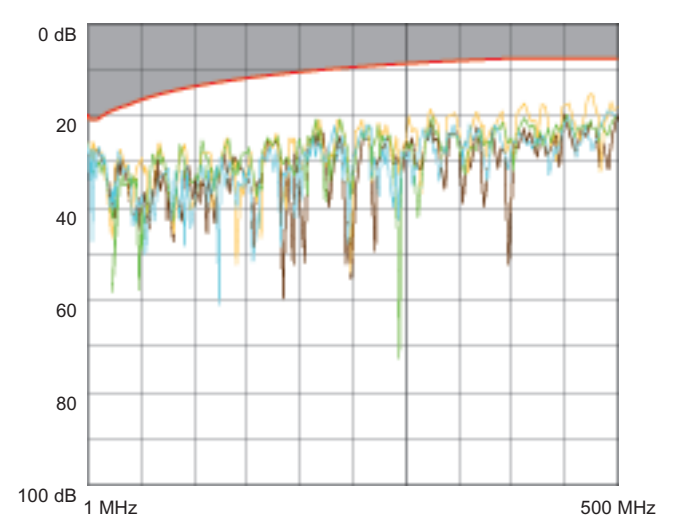

7. PERFORMANCE (cont.)

7.3 Channel performance (cont.)

Attenuation

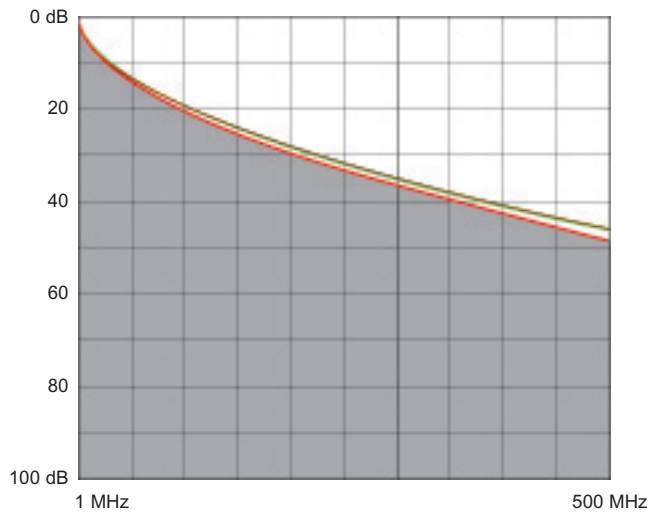

7. PERFORMANCE (cont.)

7.3 Performances canal (Channel) (cont.)

ACR (Attenuation to Crosstalk Ratio)

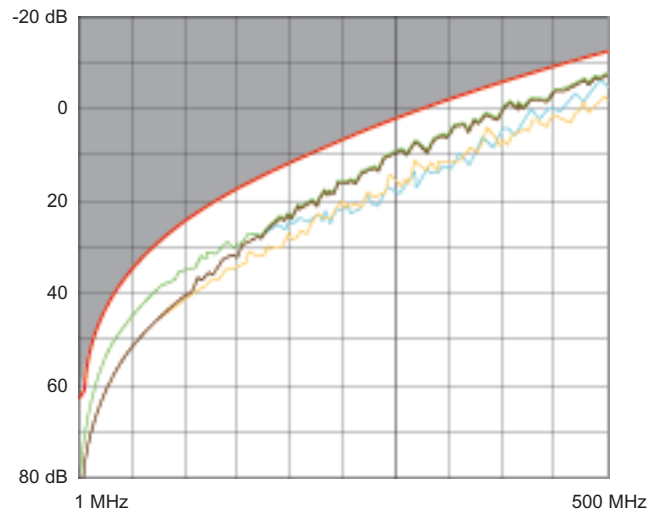

NEXT (Near end Crosstalk Attenuation)

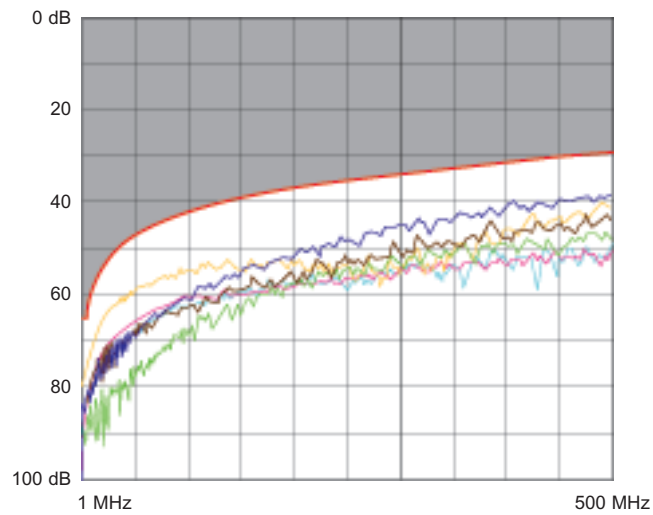

ELFEXT (Equal Level End Crosstalk Attenuation)

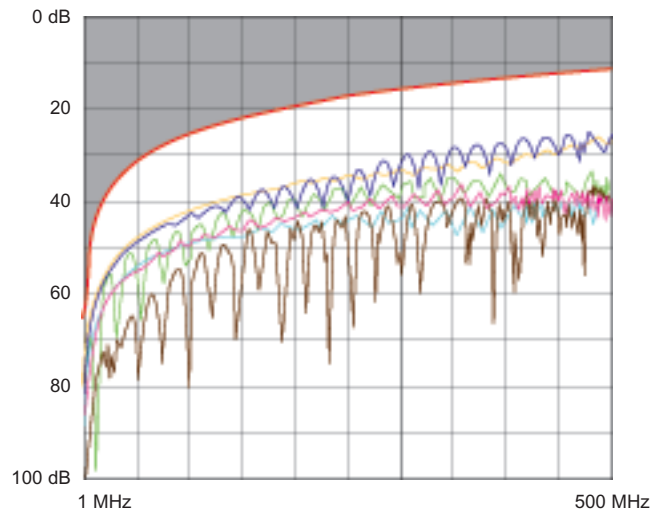

PS NEXT (Power Sum NEXT)

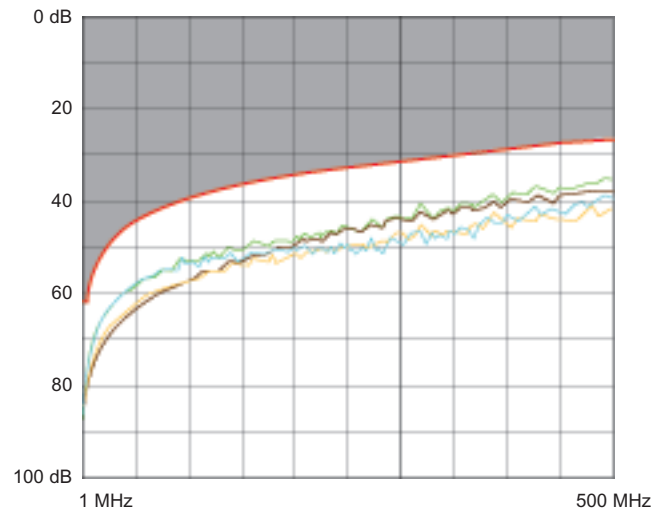

Delay skew

