

Technical Data Sheet

Description:	Main Line Branch Terminal 35 mm ² – 1 pole (Al/Cu)
Construction:	Model C – all-side fingersafe, modular system
Item no. :	080210-x-3

Remarks: The product is compliant with the EC ROHS directives

Standards: IEC 60947-7-1, IEC 61238-1 (Class A)









Nominal Voltage: 1.000 V AC / 1.000 V DC

Nominal current: Cu 202 A (2x25mm²); 125 A (1x35mm²) as per IEC 60947-7-1
Al 125 A (1x35mm²)* as per IEC 61238-1 (Class A)

* Approved with Reko SFS 4880 (manufactured by Reka Cables Ltd)

Power loss: Tested by SGS Fimko Ltd (FI) (see chart 1)

	2 x 35 mm ² (Rundleiter)			2 x 25 mm ² (round conductor)		
	Cu		Al	Cu		Al
						
35 mm ²	3,5 Nm	-	8 Nm	-	-	-
25 mm ²	3,5 Nm	3,5 Nm	6 Nm	2,5 Nm	-	6 Nm
16 mm ²	3,5 Nm	3,5 Nm	4 Nm	2,5 Nm	2,5 Nm	4 Nm
10 mm ²	3,5 Nm	3,5 Nm	-	2,5 Nm	2,5 Nm	-
6 mm ²	3,5 Nm	3,5 Nm	-	2,5 Nm	2,5 Nm	-
4 mm ²	3,5 Nm	3,5 Nm	-	2,5 Nm	2,5 Nm	-
2,5 mm ²	-	3,5 Nm	-	2,5 Nm	2,5 Nm	-
1,5 mm ²	-	-	-	-	2,5 Nm	-
stripping length	22 mm			18 mm		
screw	M8 (+/- PZ2)			M6 (+/- PZ2)		

Materials: Terminal body: brass (CuZn39Pb2) 3-4µm Ni / 7-10µm Sn
Housing: PA 6 (Halogen-free)
Screws: steel Zn thick-film passivated

Flame resistance: Self-extinguishing

Mechanical data: Dimensions: width x height x depth (mm): 29 x 49,3 x 55,4

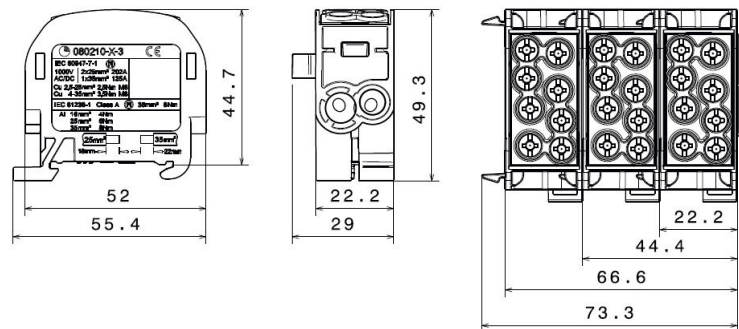
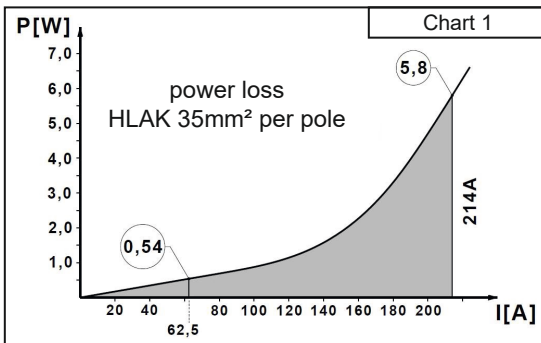

Design				
Basic housing colour – light grey RAL 7035				
Part no.	Design	Cover colour	PU	GTIN (EAN)
080210-0-3	L G	light grey RAL 7035	5	4051589021036
080210-1-3	N	light blue RAL 5012	5	4051589021135
080210-2-3	PE	yellow-green RAL 6018	5	4051589021234
080210-3-3	L B	clay brown RAL 8003	5	4051589021333
080210-4-3	L S	jet black RAL 9005	5	4051589021432
080210-5-3	R	beige red RAL 3012	5	4051589021531