

## Forix™ - IP 2X Workstations

Cat. No(s): 7 824 94/96/97

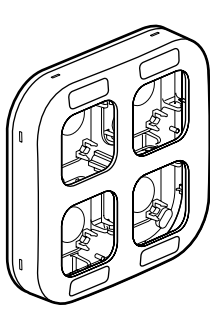

7 824 94

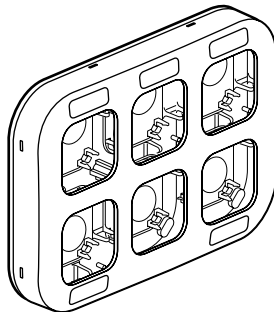

7 824 96

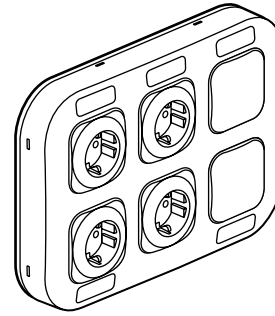

7 824 97

### 1. USE

Workstation equipped or for integration of Forix IP 2X surface mounting mechanisms or Mosaic mechanisms with adaptor Cat. No. 7 824 25. Pre-cut entries from 20 x 12.5 mm up to 40 x 12.5 mm for trunking and tube Ø 16 mm up to Ø 20 mm (6-gang).

### 2. RANGE

Finishes	Designation
White	
7 824 94	Workstation to be equipped 4-gang
7 824 96	Workstation to be equipped 6-gang
7 824 97	Workstation equipped 4 x 2 P+E German standard sockets with shutters and with 2 x blanking plates

### 3. OVERALL DIMENSIONS

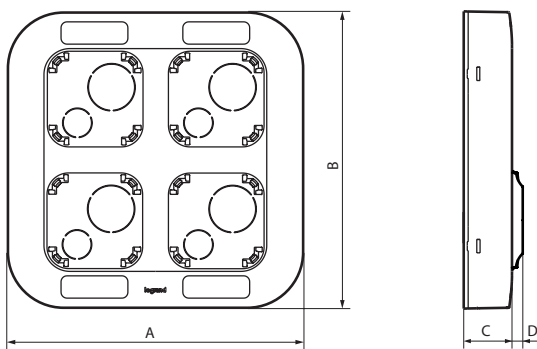

Cat. No.	A	B	C	D with Cat. No 7 824 20
7 824 94	200	200	34.5	-
7 824 96	280	200	34.5	-
7 824 97	280	200	34.5	7

### 3. OVERALL DIMENSIONS

#### ■ 3.1 Base 4 stations:

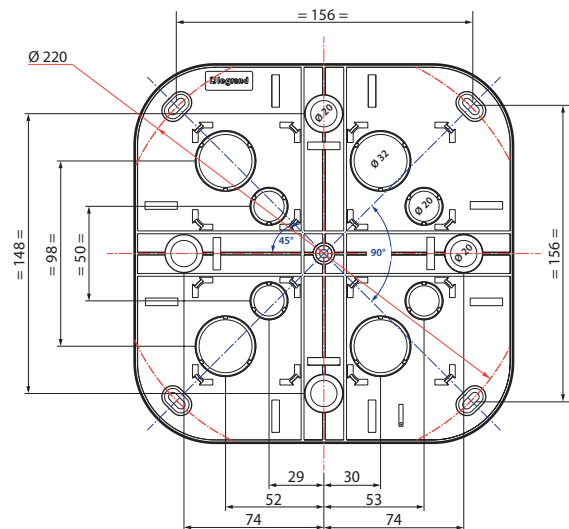

#### ■ 3.2 Base 6 stations:

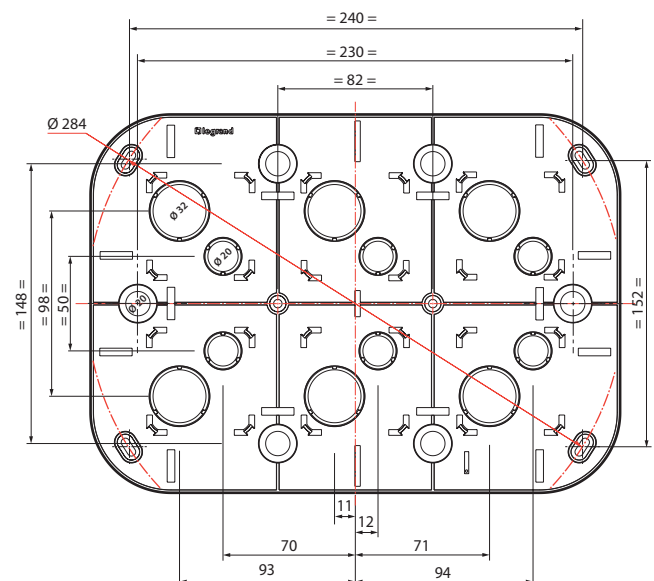

#### 4. CONNECTION

Information for pre-cut:

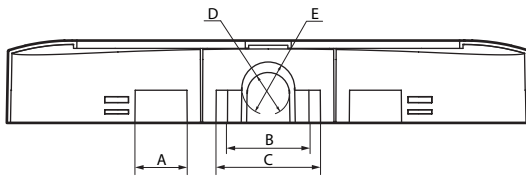

Pre-cut sides (mm)

Cat. No.	A 20 x 12.5	B 32 x 12.5	C 40 x 12.5	D Ø 16	E Ø 20
7 824 94	8	4	4	2	-
7 824 96	4	8	8	2	2
7 824 97	4	8	8	2	2

For 7 824 97

Delivered with 4 x 2 P+E German standard sockets with shutters

Cat. No. 7 824 20:

Stripping: 11 mm

Terminal type: with screws

Terminal capacity up to: 2 x 2.5 mm<sup>2</sup>

Recommended tightening torque: 0.8 Nm

#### 5. TECHNICAL CHARACTERISTICS

##### ■ 5.1 Mechanical characteristics

Protection against liquids only available for the workstation totally assembled product Cat. No 7 824 97: IP 21

Impact tests: IK 04

##### ■ 5.2 Material characteristics

Only for the workstation:

Base: ABS

Cover: ABS

##### ■ 5.3 Climatic characteristics

Storage and use temperature: - 25° C to + 60° C

#### 6. CLEANING

Surface cleaning with a cloth.

Do not use: acetone, tar remover, trichloroethylene.

Resistance to the following agents: Hexane (EN 60669-1), Methylated spirits, Soapy water, Diluted ammonia, Diluted pure bleached 10%, Glass cleaning substance, Pre-impregnated wipes.

**Caution:** A preliminary test should be carried out if other specific cleaning products are to be used.

#### 7. ACCESSORIES

##### ■ Switches

Cat. Nos 7 824 00/02/04

##### ■ Push-button

Cat. No 7 824 05

##### ■ Socket outlet 2 P - 16 A - 250 VAC

Cat. No 7 824 10

##### ■ Socket outlets german standard 2 P+E - 16 A - 250 VAC

Cat. Nos 7 824 11/20

##### ■ Socket outlet french standard 2 P+E - 16 A - 250 VAC

Cat. No 7 824 17

##### ■ Socket data

Cat. Nos 7 824 14/15/16/21/24/26/28

##### ■ Dismatic 20 A

Cat. No 7 824 29

##### ■ Mosaic adaptor

Cat. No 7 824 25

##### ■ Blanking plate

Cat. No 7 824 95