

[www.legrandoc.com](http://www.legrandoc.com)

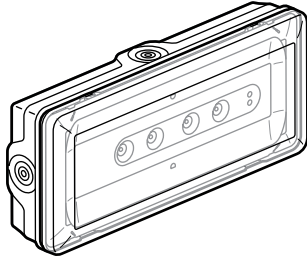

Standard: 6 614 31/33/34/40  
Addressable LVS: 6 624 31/33/34/40

**CONTENTS**

Page

1. Description ..... 1  
 2. Installation ..... 2  
 3. Operation ..... 3  
 4. Connection ..... 4  
 5. Addressing an LVS luminaire with the configuration tool ..... 6  
 6. Photometric data ..... 8  
 7. Maintenance ..... 8  
 8. Compliance and approvals ..... 9  
 9. Accessories ..... 9

**1. DESCRIPTION**

IP 65 - IK 07 emergency luminaires with LEDs  
 Class II:

Cat. No.	Flux/ standby	STD/ LVS	Mode	M cons.	NM cons.	Type of battery
6 614 31	100 lm/1 hr	STD	M/NM	4	2	NiCd
6 614 33	200 lm/1 hr	STD	M/NM	4	2	NiCd
6 614 34	350 lm/1 hr	STD	M/NM	4	2	NiCd
6 614 40	100 lm/3 hrs	STD	M/NM	3	0.8	NiMH
6 624 31	100 lm/1 hr	LVS	M/NM	4	2	NiCd
6 624 33	200 lm/1 hr	LVS	M/NM	4.2	2	NiCd
6 624 34	350 lm/1 hr	LVS	M/NM	3	0.8	NiMH
6 624 40	100 lm/3 hrs	LVS	M/NM	3	0.8	NiMH

**• Delivery**

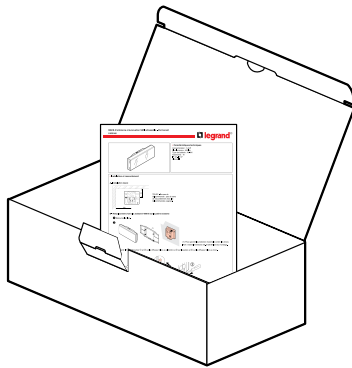

**1. DESCRIPTION (CONTINUED)**

**• Dimensions**

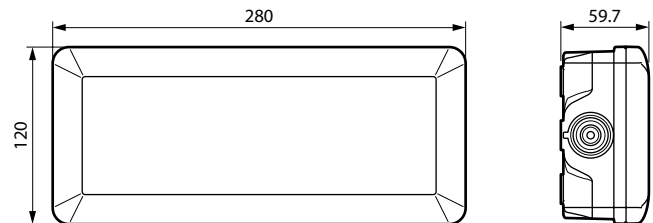

Weight of product in packaging: 700 grammes  
 Volume of product in packaging: 2.3 dm<sup>3</sup>

**• Technical characteristics**

230 V~ - 50/60 Hz power supply  
 Fitted with large capacity automatic connection terminals (2 x 2.5 mm<sup>2</sup>)  
 Class II:   
 Operating temperature: 0°C to +40°C.  
 Remote control for setting to rest state during intentional mains power breaks.  
 Remote control input terminals protected against errors of connection.  
 Terminal used to switch the maintained part of the light on and off in M/ NM units.  
 Complies with standards: EN 60598-2-22  
 Awarded the ENEC EN 60 598 2-22 and AENOR quality mark  
 Product for surface mounting on walls or ceilings.

**1. DESCRIPTION (CONTINUED)**

• **Materials**

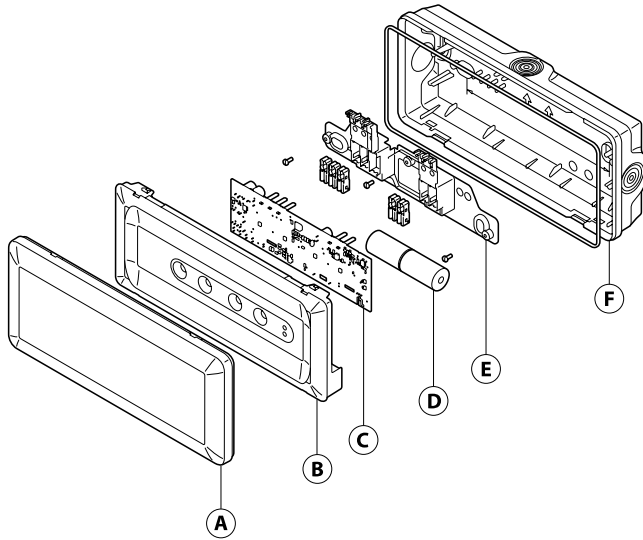

- (A) Diffuser: self-extinguishing opal polycarbonate 750° 30 s
- (B) Reflector: self-extinguishing white polycarbonate 850° 30 s
- (C) Electronic board
- (D) Battery
- (E) Terminal support plate: polypropylene self-extinguishing 850°C 30 s
- (F) Removable base: polypropylene self-extinguishing 850°C 30 s

All plastic parts weighing more than 50 g are marked with their material type so that the materials can be recycled at the end of the life of the product.

**2. INSTALLATION**

• **Opening the unit**

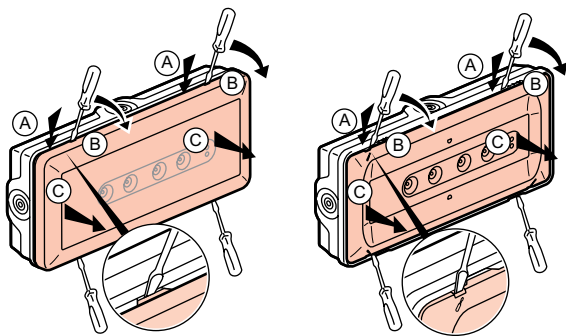

**2. INSTALLATION (CONTINUED)**

• **Fixing**

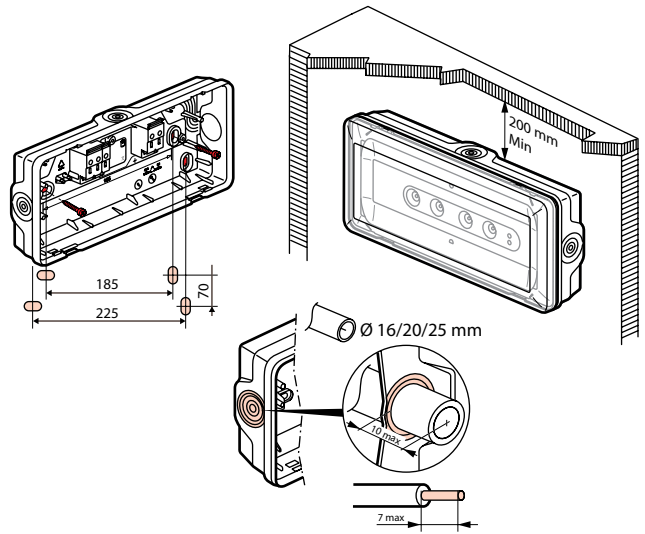

• **Wiring**

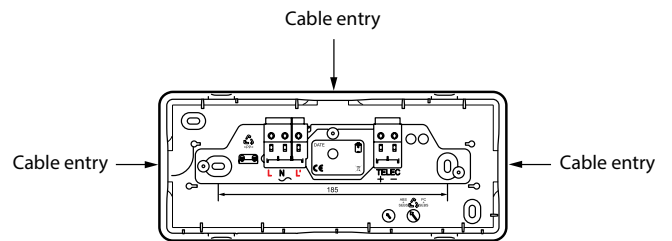

REMOTE CONTROL - Connection terminals: no polarity with the Legrand remote control Cat. No. 0 039 00/01.  
Terminal capacity: 2 x 2.5 mm<sup>2</sup>.

• **If wiring with flexible wires**

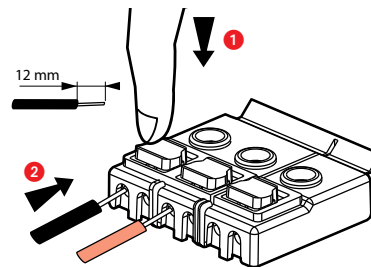

## 2. INSTALLATION (CONTINUED)

### • Wiring in maintained mode

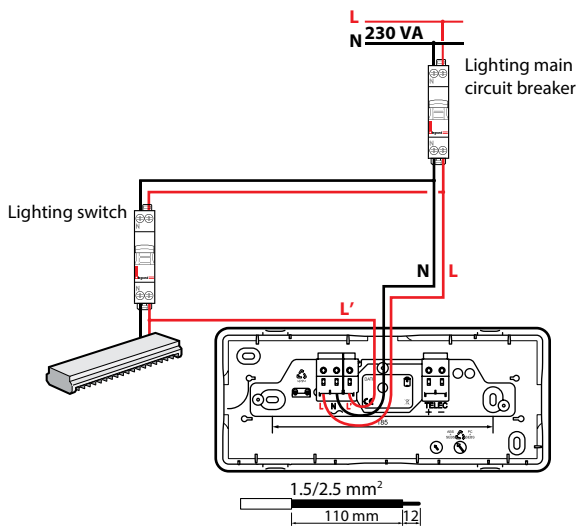

### • Wiring in non-maintained mode

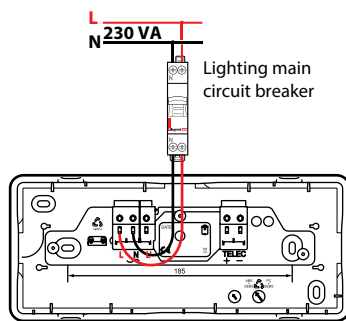

## 3. OPERATION

### ■ 3.1 Switch-on/standby state

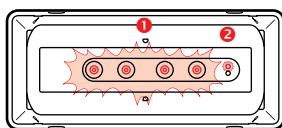

#### Maintained

- 1 The emergency LEDs come on (flux  $\approx$  100 lumens) if terminal L' is powered
- 2 Luminaire green status LED on

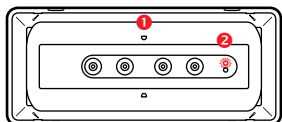

#### Non-maintained

- 1 The emergency LEDs are off
- 2 Luminaire green status LED on

### ■ 3.2 Mains supply break/emergency operation

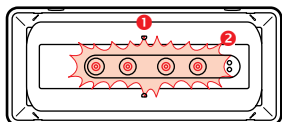

#### Maintained

- 1 The emergency LEDs come on at rated flux
- 2 Luminaire green status LED goes off

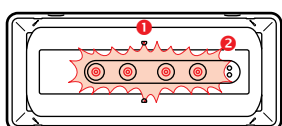

#### Non-maintained

- 1 The emergency LEDs come on at rated flux
- 2 Luminaire green status LED goes off

## 3. OPERATION (CONTINUED)

### ■ 3.3 Setting to rest state via the remote control Cat. No. 0 039 00/01

#### After the normal lighting is switched off intentionally:

Pressing the button sets the unit to rest state to prevent the battery discharging.

#### Normal lighting switched back on:

The luminaire automatically returns to standby in the initial operating mode (M/NM).

### ■ 3.4 Testing standard luminaires

Standard luminaires can be tested by a normal power break:

- switch-on is verified correctly when the emergency LEDs are on
- standby power is verified correctly when the emergency LEDs stay on throughout the rated standby power time (1 or 3 hours).

### ■ 3.5 Testing LVS luminaires

LVS luminaires incorporate two operating modes: Self-test mode and addressable mode.

#### Self-test mode

LVS luminaires are factory-configured in Self-test mode, and can therefore be used in this mode without requiring any change of setting.

#### Addressable mode

This luminaire can also be used on an addressable system. For this it must be addressed using the infrared configuration tool Cat. No. 0 626 10 in accordance with the procedure described in section 6. It then becomes possible to control it remotely using the control interface Cat. No. 0 626 00 (for more detailed information, see the addressable luminaires installation manual supplied with Cat. No. 0 626 00).

### 3.5.1 Automatic checking of the luminaire status (Self-test system)

This luminaire automatically checks its operating status.

This operating mode is only available for LVS luminaires.

#### Once a week:

Switches to emergency state for 15 seconds and tests switching to emergency operation and the light sources.

#### Once every three months:

Switches to emergency operation for the rated standby power time (1 hr; 3 hrs) and tests the battery standby power.

### 3.5.2 Result of the automatic checks

LEDs	Luminaire OK	Battery fault	Other fault(s)
Green	(steady or flashing)		
Yellow		(steady)	(rapid flashing)

The time of the tests is set at the time the luminaire is first switched on. The day of the test is chosen randomly in order to ensure that a minimum number of luminaires is tested at the same time.

The time at which all the luminaires are tested can be changed to the required time by simultaneously pressing the and buttons on the remote control.

### 3.5.3 Stopping a test in progress

If a standby power test hinders operation, it can be stopped immediately. Press the OFF button on the remote control unit Cat. No. 0 039 00 or on the control interface Cat. No. 0 626 00. The test is stopped and postponed until the following day.

**3. OPERATION (CONTINUED)**

**3.5.4 Special cases**

When the luminaire has been switched off for more than 3 days, the tests are no longer carried out. The test cycle will resume after the luminaire is switched back on and the batteries have been recharged. The tests planned for the day the luminaire is switched back on are automatically postponed for 24 hours.

**4. CONNECTION**

**4.1 Connecting the mains power to the self-contained luminaires**

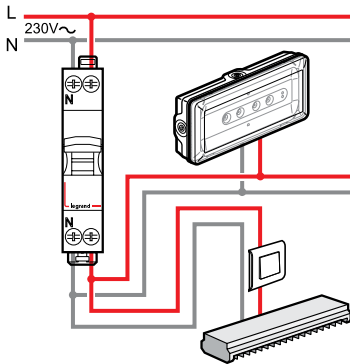

The branch can be joined in the electric cabinet, on the switch or in a junction box. The power supply to the luminaires is subject to the same rules as the luminaires (normal wiring).

The polarity of the remote control need not be followed on LVS luminaires if a Legrand remote control Cat. No. 0 039 00 or 0 039 01 is used. If another remote control is used, the polarity must be followed when wiring, and the switch-on or switch-off command must be maintained for at least 2 seconds.

**4. CONNECTION (CONTINUED)**

**4.2 Connecting the remote control**  
**Remote control for setting to rest state**

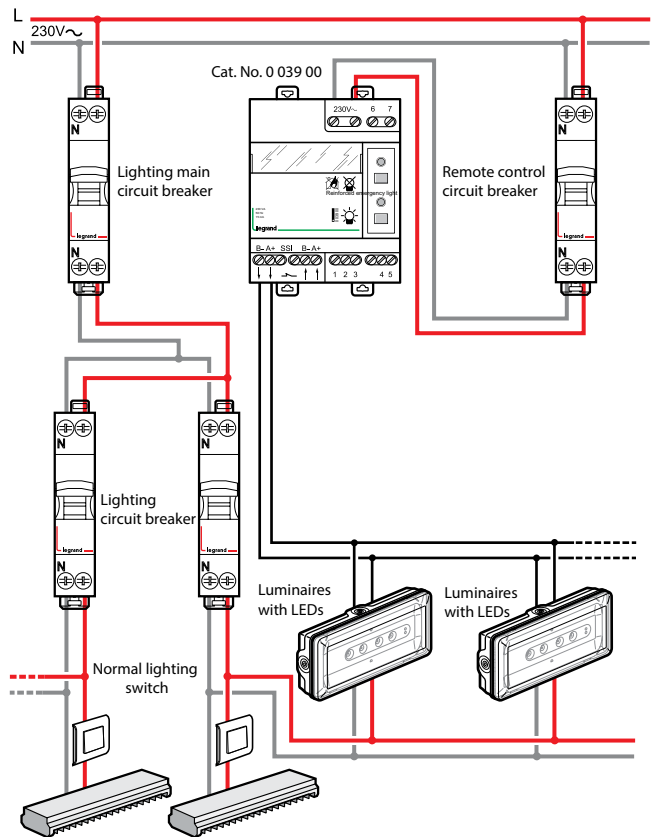

**4. CONNECTION (CONTINUED)**

■ **4.3 Connection for an addressable installation for LVS luminaires (Cat. Nos. 6 624 31/33/34/40 only)**  
**Installation with general setting to rest state**

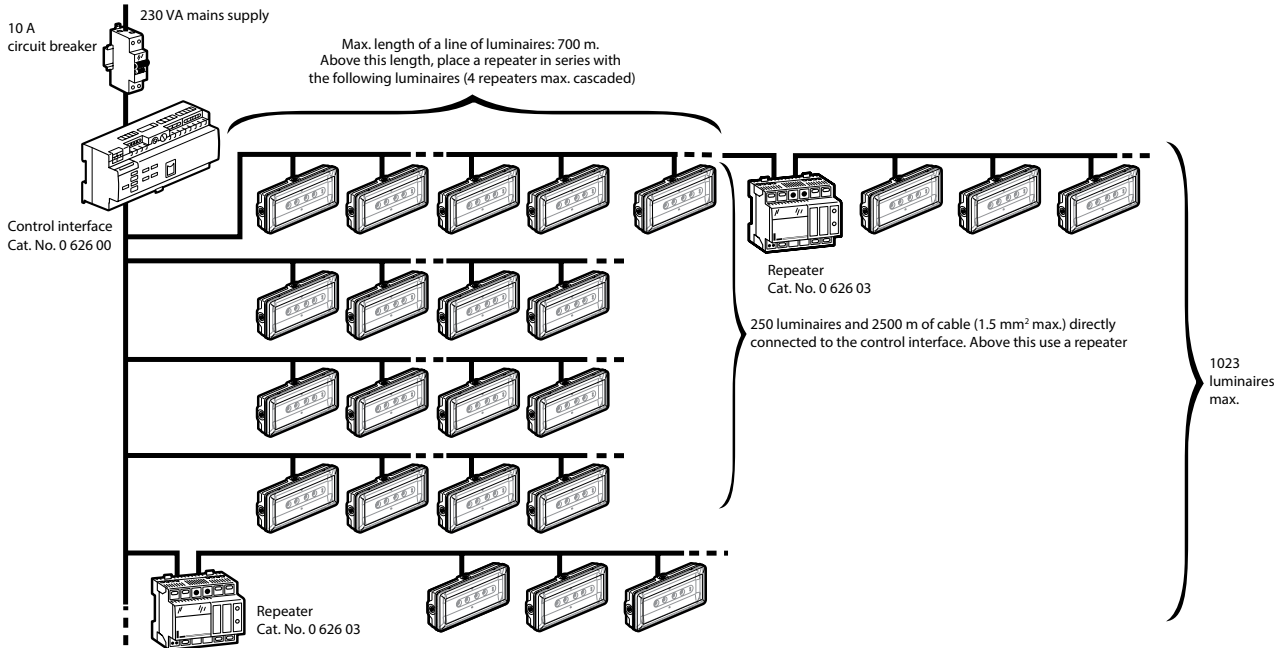

**Installation with partial setting to rest state**

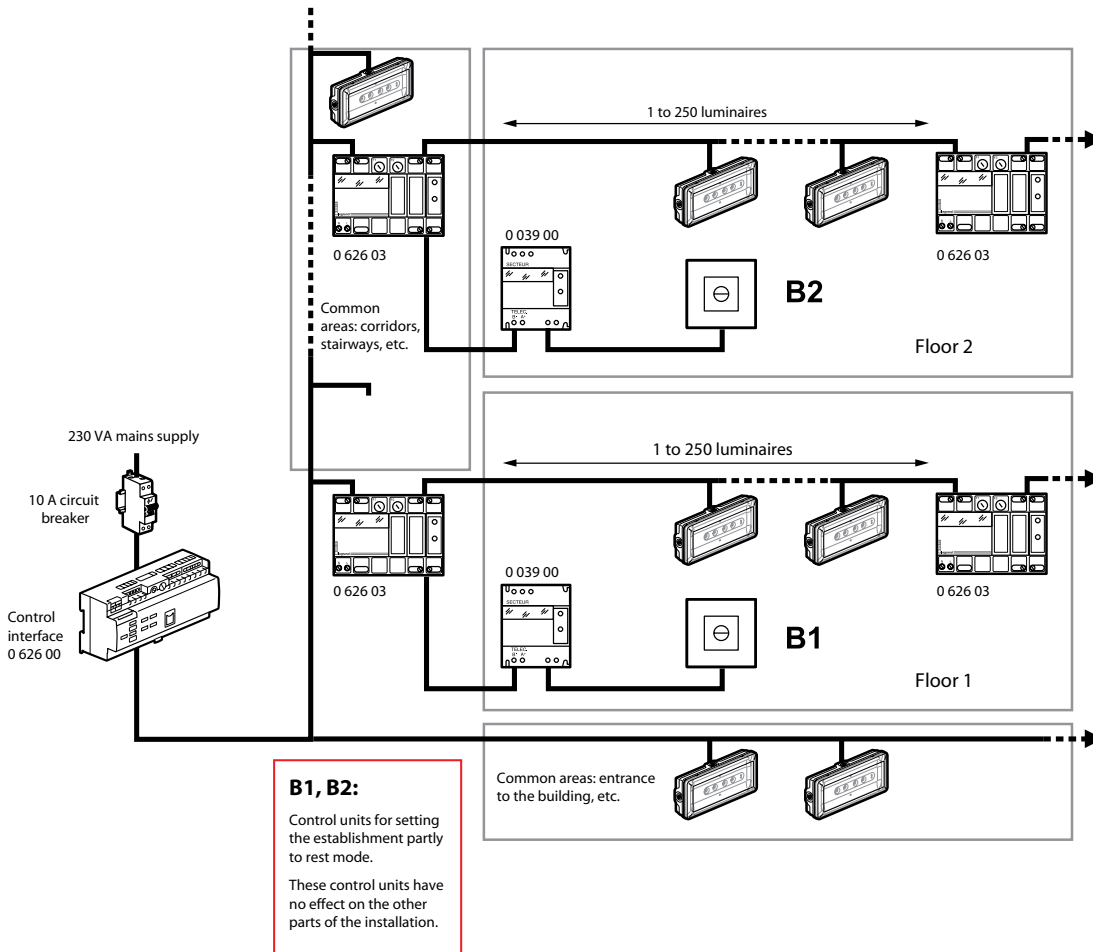

**5. ADDRESSING AN LVS LUMINAIRE WITH THE CONFIGURATION TOOL CAT. NO. 0 626 10**

**5.1 Programming the address with the configuration tool loaded using the interface configuration software**



1 Turn on the configuration tool by pressing OK for 2 seconds.

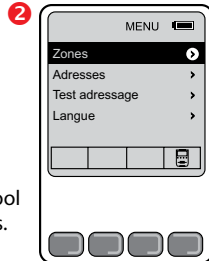

2 Select the Zones line in the main menu

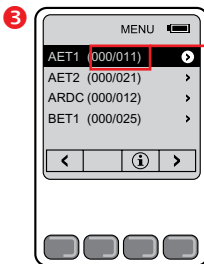

3 Indicates the number of luminaires in the zone and how many are addressed: here there are 11 luminaires in this zone and 0 addressed.



Select the zone in which you wish to address the luminaires.

**5. ADDRESSING AN LVS LUMINAIRE WITH THE CONFIGURATION TOOL CAT. NO. 0 626 10**

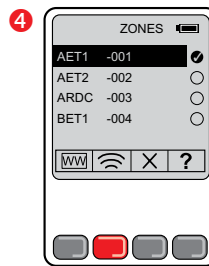

**Explanation of the buttons:**

**WWW** Used to give the switch position for switched luminaires.

**WiFi** Used to address the luminaire by standing under it with the configuration tool (the luminaire emergency LEDs come on for 2 seconds).

**!** The luminaire must not already have an address.



**X** Used to delete addressing in a luminaire with this address. Address 0000 is used to delete addressing regardless of the unit address (the emergency LEDs come on twice for 2 seconds). This step is essential when changing the luminaire address.

**?** Used to test the addressed luminaire (the luminaire emergency LEDs come on for 2 seconds to signal that the luminaire contains the unit address and the standby LEDs go off to signal that the luminaire does not have the right address).

5 **!** The luminaire must be powered up.

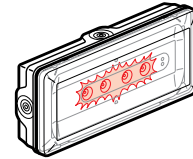
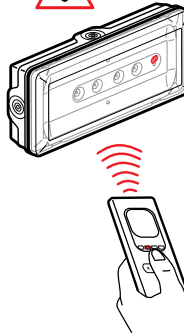

The luminaire has registered the address, so its emergency LEDs come on for 2 seconds.

Max. distance between remote control and luminaire of 0.1 to 2 m.

**5. ADDRESSING AN LVS LUMINAIRE WITH THE CONFIGURATION TOOL CAT. NO. 0 626 10**

**5.2 Programming a known address with the configuration tool**

For example address 0000.

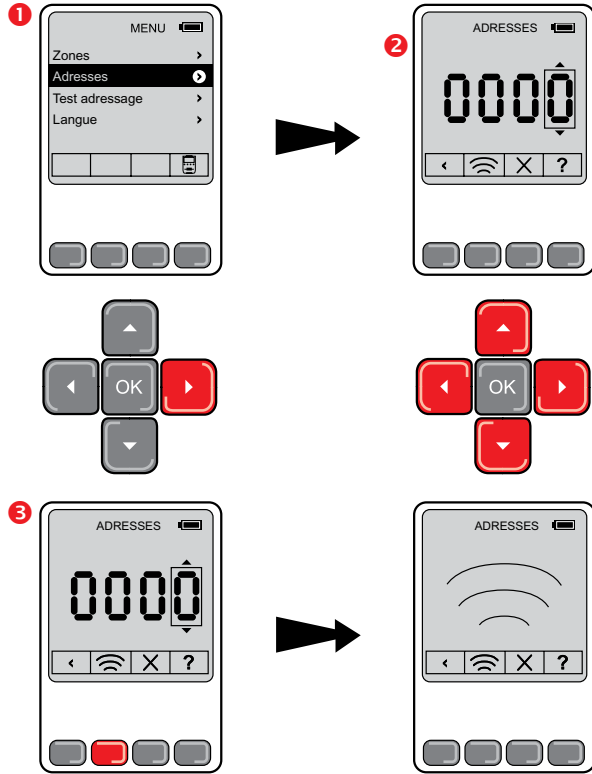

**Explanation of the buttons:**

Used to address the luminaire by standing under it with the configuration tool (the luminaire emergency LEDs come on for 2 seconds).

The luminaire must not already have an address.

Used to delete addressing in the luminaire with this address. Address 0000 is used to delete addressing regardless of the unit address (the emergency LEDs come on twice for 2 seconds). This step is essential when changing the luminaire address.

Used to test the addressed luminaire (the luminaire emergency LEDs come on for 2 seconds to signal that the luminaire contains the unit address and the standby LEDs go off to signal that the luminaire does not have the right address).

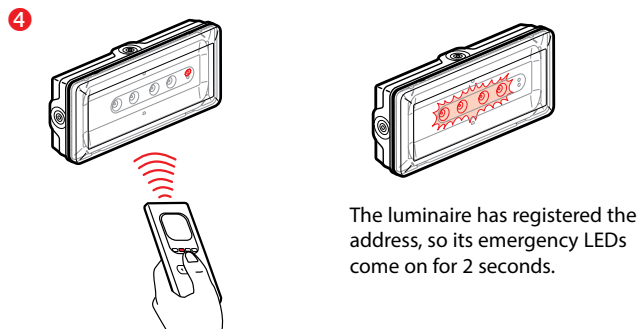

Max. distance between remote control and luminaire of 0.1 to 2 m.

**5. ADDRESSING AN LVS LUMINAIRE WITH THE CONFIGURATION TOOL CAT. NO. 0 626 10**

**5.3 Testing a particular address**

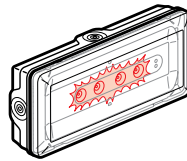
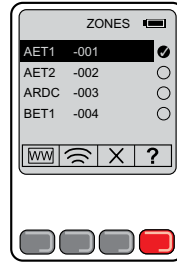

If the address in the luminaire is the address being tested, its emergency LEDs come on for 2 seconds.

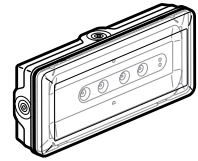

If the luminaire has another address or no address, the luminaire switches off its LED indicator.

**5.4 Testing whether the luminaire is addressed**

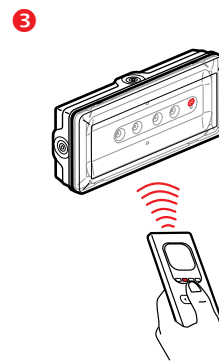
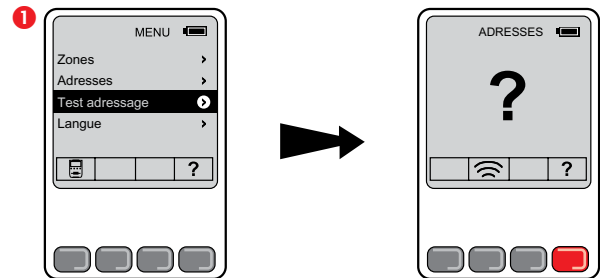

Max. distance between remote control and luminaire of 0.1 to 2 m.

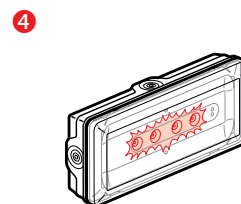

The luminaire has an address, so its emergency LEDs come on for 2 seconds.

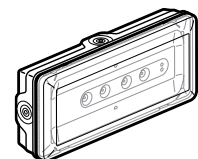

The luminaire does not have an address, so it switches off its LED indicator.



**5. ADDRESSING A LUMINAIRE WITH THE CONFIGURATION TOOL CAT. NO. 0 626 10 (CONTINUED)**

■ 5.5 Deleting the address of a unit

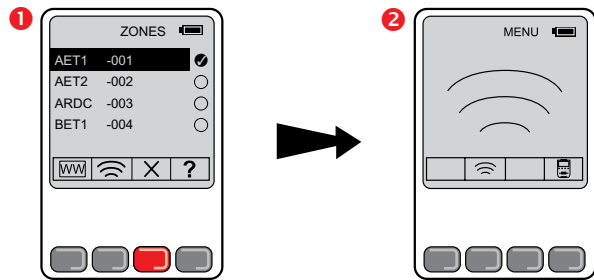

Max. distance between remote control and luminaire of 0.1 to 2 m.

**6. PHOTOMETRIC DATA**

The photometric data for all these luminaires are available in the Legrand Dialux plug-in which can be obtained from the Legrand website.

**7. MAINTENANCE**

■ 7.1 Spare parts

Luminaire Cat. No.	Battery	Spare battery Cat. No.
6 614 31	2.4 V 1.5 Ah NiCd	0 610 92
6 614 33/6 624 31	3.6 V 1.5 Ah NiCd	6 609 72
6 614 34/6 624 33	4.8 V 1.5 Ah NiCd	6 609 62
6 614 40/6 624 34/6 624 40	4.8 V 2 Ah NiMH	6 609 71

**7. MAINTENANCE (CONTINUED)**

■ 7.2 Replacing the batteries

The batteries must be replaced when the self-contained luminaire no longer works for its rated operating time.

**Caution:** this product must be switched off before dismantling.

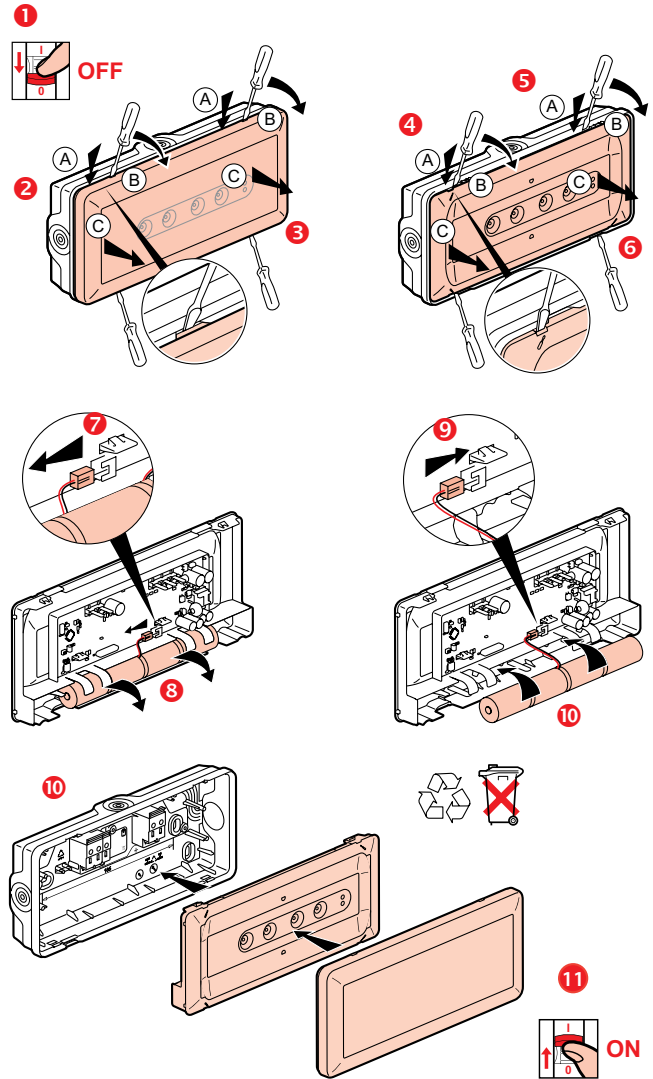

• **NB:** The LEDs cannot be replaced

Legrand distribution partners take back used luminaires and batteries. When the batteries have been changed, replace the maintenance label, marking on it the date on which the luminaire is returned to service.



## 8. COMPLIANCE AND APPROVALS

EN 60 598-2-22: European standard "Luminaires: specific rules. Luminaires for emergency lighting"

EN 60 598-1: European standard "Luminaires"

EN 50172: European standard "Emergency escape lighting systems"

EN 1838: European standard "Lighting applications – Emergency lighting"

Products certified to the AENOR N quality mark

### Electromagnetic effects: EMC

#### Emission

- EN 55015 (disturbance voltages)
- EN 61000-3-2 (measurement of harmonics) class C
- EN 55022 (radiated interference) class B

#### Immunity

- EN 61000-4-2 (electrostatic discharges) criterion B 4 kV (contact)
- EN 61000-4-3 (radiated fields) criterion A 10 V/m
- EN 61000-4-4 (fast transients/bursts) criterion B 4 kV on network and 1 kV by coupling
- EN 61000-4-5 (lightning impulses) criterion B
- EN 61000-4-6 (conducted disturbances) criterion A
- EN 61000-4-8 (magnetic fields) criterion A
- EN 61000-4-11 (voltage dips and short interruptions)

## 9. ACCESSORIES

### Self-adhesive legend plates

- Conforming to standard EN ISO 7010:



6 616 70

- Other suggested solutions:

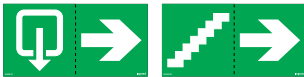

6 616 71

6 616 72



6 616 80



6 616 81



6 616 82



6 616 83



6 616 84



6 616 85



6 616 86



6 616 87



6 616 88



6 616 89



6 616 90



6 616 91