

**10" PDUs**  
**19" PDUs**  
**Zero-U PDUs**

**Cat. Nos: 6 468 00/01/05/06/07/09/10/11/12/13/14/15/18/19/20/  
 21/22/23/24/30/31/32/33/35/36/40/41/42/43/44/  
 45/50/51/52/53/54/56/57/59/60/61/65/70/75/90/92/94/  
 95/97/98/99**



**CONTENTS**

**Page**

1. GENERAL CHARACTERISTICS .....	1
2. EQUIPMENT AND PERFORMANCE .....	3
3. FUNCTIONS.....	8
4. DIMENSIONS .....	11
5. INSTALLATION .....	12

**1. GENERAL CHARACTERISTICS**

**1.1 Presentation**

Legrand PDUs are designed for supplying power to equipment in 19" enclosures.

They comprise:

- an aluminium casing
- socket modules
- additional functions
- a termination solution
- a mounting solution

Single-phase 230V – 50/60 Hz or three-phase 380 V – 50/60 Hz power supply

The range features three main product families:

- PDUs designed for horizontal installation (10" and 19" PDUs)
- PDUs designed for vertical installation (Zero-U PDUs)
- Accessories

PDUs designed for horizontal installation (10" and 19" PDUs)

10" PDUs to be installed on 10" mounting uprights and 19" PDUs to be installed on 19" mounting uprights. 1U height casing for compactness. Integrated cable guide. Screwless snap-on fixing. End pieces with 180° reversible metal brackets for vertical mounting capability.

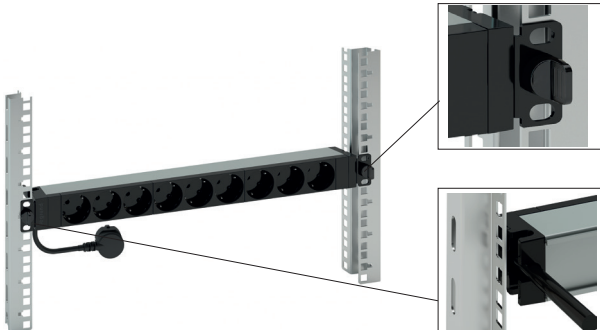

PDUs designed for vertical installation (Zero-U PDUs)

For vertical installation on the rear of cabinets to save 19" space within it.

Cable inlet can be rotated 330° to ensure perfect alignment of the power cable.

Supplied with 2 sets of metal fixings: button for screwless fixing, or standard screw-type brackets.

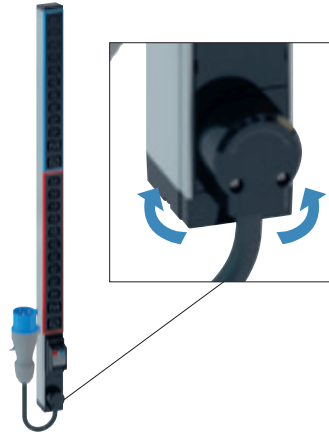

Accessories

- Replacement surge protection module to ensure continuity of service
  - Locking caps for locking out the use of an outlet
- See the detailed description of these accessories in the "Functions" section.

Legrand's PDU offer is available as standard catalogue versions (see the corresponding descriptions in the "Equipment and performance" section) and as customized configurations.

**1.2 Mechanical characteristics**

- Casing: 6060 T5-R19 natural anodised aluminium

Dimensions in mm:

1U casing

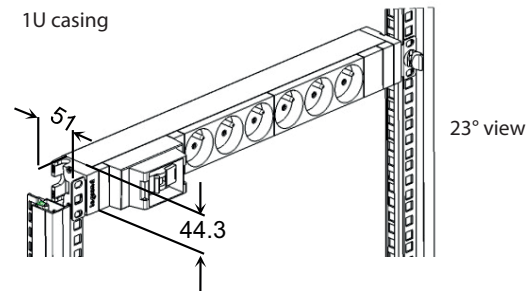

1U casing

View from above

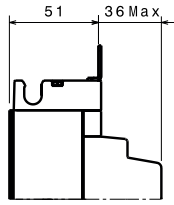

End view

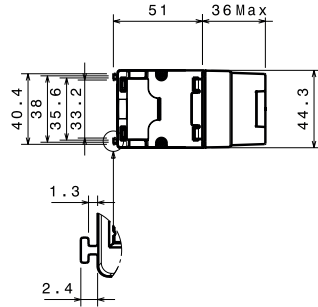

Zero-U casing

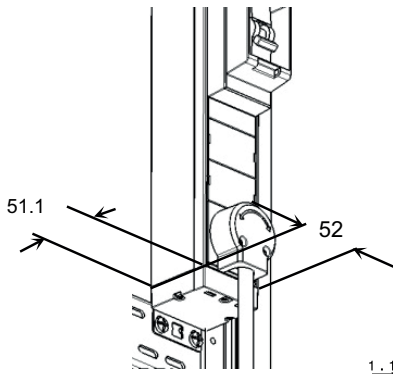

Side view

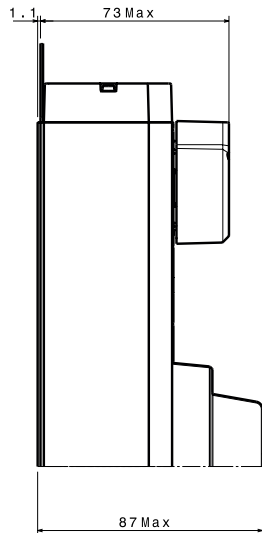

End view

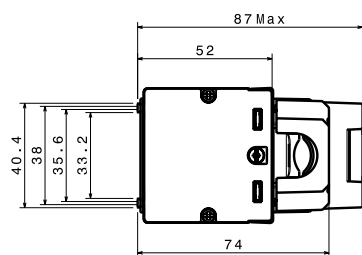

- Outlet modules:

PC/ABS  
CW507L (CuZn 36) brass

- Fixing brackets:

DC01-A-m galvanised steel

■ 1.3 Standards, regulations and tests

Depending on what equipment they comprise, the PDUs comply with the current applicable standards below:

Application	Standard
French/Belgian standard plugs/outlets	IEC/TR 60083
German standard plugs/outlets	
UK standard plugs/outlets + electrical accessories	
Italian standard outlets	
Swiss standard outlets	
C13 and C19 connectors for electrical equipment	IEC 60320-2-2
Low voltage surge protection device	IEC 6164-11
Switch	IEC 60058-1
MCB	IEC 60898-1
RCBO	IEC 61008-1
Thermal circuit breaker	IEC 60730-2-9
Industrial plug	IEC 60309-1
Information-processing equipment	IEC 60950-1

IP: IP40 for French/Belgian, German, Swiss, Italian and UK standards and IP20 for electrical appliance connectors (C13 and C19)

IK07

**Glow-wire flammability test:** The various different standard outlets and the other functions that equip the PDUs meet the requirements of their respective standards relating to abnormal heat and fire resistance and comply with the following thresholds:

- Plastic parts in contact with live parts: 750 °C
- Other plastic parts: 650 °C

**Temperature rise:** The PDUs are compliant with the standard temperature rise limit of 45 °C for French/Belgian, German, Swiss and Italian standards and electrical appliance connectors (C13 and C19) and 52 °C for the UK standard.

**Final inspection:** Compliant with European standard requirements and Legrand's own manufacturing requirements, all products undergo production tests, including:

- Electrical continuity to ensure the product is wired correctly
- Dielectric strength at 2000 V to ensure there is no leakage current
- Operating test

**RoHS and REACH conformity:** The PDUs comply with European standards and therefore meet the requirements of the RoHS directive (Restriction of Hazardous Substances) and REACH regulations (Registration, Evaluation, Authorisation & restriction of Chemicals).

## 2. EQUIPMENT AND PERFORMANCE

### ■ 2.1 Composition of each catalogue number

#### 10" PDUs

	6 468 98	6 468 00	6 468 01
Number of phases	1	1	1
Input voltage	230 V	230 V	230 V
Input current	16 A	16 A	16 A
Maximum power	3.7kW	3.7kW	3.7kW
Termination method		Cord	Cord
Cable length		1 m	1 m
Cable material		PVC HOSVVF	PVC HOSVVF
Cable cross-section		3G 1.5	3G 1.5
Plug type		Schuko/UTE	Schuko/UTE
Cable retention method		Cable clamp + guide	Cable clamp + guide
Number and type of outlets		4 French/Belgian	4 German
Outlets colour		Black	Black
Angle of outlets		55°	55°
Number of circuits per phase		1	1
Casing	Zero-U aluminium	1U aluminium	1U aluminium
Fixings (included)	19" reversible bracket + snap-on fixing	19" reversible bracket + snap-on fixing	19" reversible bracket + snap-on fixing

#### 19" PDUs

	6 468 05	6 468 06	6 468 07	6 468 09	6 468 10	6 468 11	6 468 12	6 468 13	6 468 14
Number of phases	1	1	1	1	1	1	1	1	1
Input voltage	230 V	230 V	230 V	230 V	230 V	230 V	230 V	230 V	230 V
Input current	16 A	16 A	16 A	16 A	16 A	16 A	16 A	13 A	16 A
Maximum power	3.7kW	3.7kW	3.7kW	3.7kW	3.7kW	3.7kW	3.7kW	3kW	3.7kW
Termination method	Cord	Cord	Terminal block**	Terminal block**	Cord	Cord	Cord	Cord	Terminal block**
Cable length	3 m	3 m			3 m	3 m	3 m	3 m	
Cable material	PVC HOSVVF	PVC HOSVVF			PVC HOSVVF	PVC HOSVVF	PVC HOSVVF	PVC HOSVVF	
Cable cross-section	3G 1.5	3G 1.5			3G 1.5	3G 1.5	3G 1.5	3G 1.5	
Plug type	Schuko/UTE	Schuko/UTE			Schuko/UTE	Schuko/UTE	Schuko/UTE	BS 1363	
Cable retention method	Cable clamp + guide	Cable clamp + guide	Cable clamp + guide	Cable clamp + guide	Cable clamp + guide	Cable clamp + guide	Cable clamp + guide	Cable clamp + guide	Cable clamp + guide
Number and type of outlets*	6 French/Belgian	6 German	6 C19 with locking	6 C13 + 2 C19 with locking	9 French/Belgian	9 French/Belgian tamper-proof	9 German	8 UK	10 C13 with locking
Outlet colour	Black	Black	Black	Black	Black	Red	Black	Black	Black
Angle of outlets	55°	55°	90°	90°	55°	55°	55°		90°
Number of circuits per phase	1	1	1	1	1	1	1	1	1
Additional functions									
Casing	1U aluminium	1U aluminium	1U aluminium	1U aluminium	1U aluminium	1U aluminium	1U aluminium	1U aluminium	1U aluminium
Fixings (included)	19" reversible bracket + snap-on fixing								

\* Outlets are equally distributed on each circuit

\*\* Maximum capacity of terminal block 6 mm<sup>2</sup>

**10" PDUs**  
**19" PDUs**  
**Zero-U PDUs**

**Cat. Nos: 6 468 00/01/05/06/07/09/10/11/12/13/14/15/18/1  
9/20/21/22/23/24/30/31/32/33/35/36/40/41/42/43/44/  
45/50/51/52/53/54/56/57/59/60/61/65/70/75/90/92/94/  
95/97/98/99**

19" PDUs (continued)

	<b>6 468 15</b>	<b>6 468 18</b>	<b>6 468 19</b>	<b>6 468 20</b>	<b>6 468 21</b>	<b>6 468 22</b>	<b>6 468 23</b>	<b>6 468 24</b>	<b>6 468 30</b>
Number of phases	1	1	1	1	1	1	1	1	1
Input voltage	230 V	230 V	230 V	230 V	230 V	230 V	230 V	230 V	230 V
Input current	16 A	16 A	16 A	16 A	16 A	16 A	16 A	13 A	16 A
Maximum power	3.7kW	3.7kW	3.7kW	3.7kW	3.7kW	3.7kW	3.7kW	3kW	3.7kW
Termination method	Cord	Cord	Cord	Cord	Cord	Cord	Cord	Cord	Cord
Cable length	3 m	3 m	3 m	3 m	3 m	3 m	3 m	3 m	3 m
Cable material	PVC HO5VVF	PVC HO5VVF	PVC HO5VVF	PVC HO5VVF	PVC HO5VVF	PVC HO5VVF	PVC HO5VVF	PVC HO5VVF	PVC HO5VVF
Cable cross-section	3G 1.5	3G 1.5	3G 1.5	3G 1.5	3G 1.5	3G 1.5	3G 1.5	3G 1.5	3G 1.5
Plug type	IEC 60309 16 A 2P+E	T23 SEV 1011	T23 SEV 1011	Schuko/ UTE	Schuko/ UTE	Schuko/ UTE	Schuko/ UTE	BS 1363	Schuko/ UTE
Cable retention method	Cable clamp + guide	Cable clamp + guide	Cable clamp + guide	Cable clamp + guide	Cable clamp + guide	Cable clamp + guide	Cable clamp + guide	Cable clamp + guide	Cable clamp + guide
Number and type of outlets*	12 C13 with locking	12 T13 Swiss standard	12 T23 Swiss standard	9 French/ Belgian	9 German	8 French/ Belgian	8 German	6 UK	6 French/ Belgian
Outlet colour	Black	Black	Black	Black	Black	Black	Black	Black	Black
Angle of outlets	90°	90°	90°	55°	55°	55°	55°		55°
Number of circuits per phase	1	1	1	1	1	1	1	1	1
Additional functions				Power indicator	Power indicator	Luminous switch	Luminous switch	Luminous switch	1P MCB C16 6 kA Cat.No. 4 136 06
Casing	1U aluminium	1U aluminium	1U aluminium	1U aluminium	1U aluminium	1U aluminium	1U aluminium	1U aluminium	1U aluminium
Fixings (included)	19" reversible bracket + snap-on fixing								

\* Outlets are equally distributed on each circuit

19" PDUs (continued)

	<b>6 468 31</b>	<b>6 468 32</b>	<b>6 468 33</b>	<b>6 468 35</b>	<b>6 468 36</b>	<b>6 468 40</b>	<b>6 468 41</b>	<b>6 468 42</b>	<b>6 468 43</b>
Number of phases	1	1	1	1	1	1	1	1	1
Input voltage	230 V	230 V	230 V	230 V	230 V	230 V	230 V	230 V	230 V
Input current	16 A	16 A	16 A	16 A	16 A	16 A	16 A	16 A	16 A
Maximum power	3.7kW	3.7kW	3.7kW	3.7kW	3.7kW	3.7kW	3.7kW	3.7kW	3.7kW
Termination method	Cord	Cord	Cord	Cord	Cord	Cord	Cord	Cord	Terminal block**
Cable length	3 m	3 m	3 m	3 m	3 m	3 m	3 m	3 m	
Cable material	PVC HO5VVF	PVC HO5VVF	PVC HO5VVF	PVC HO5VVF	PVC HO5VVF	PVC HO5VVF	PVC HO5VVF	PVC HO5VVF	
Cable cross-section	3G 1.5	3G 1.5	3G 1.5	3G 1.5	3G 1.5	3G 1.5	3G 1.5	3G 1.5	
Plug type	Schuko/UTE	Schuko/UTE	Schuko/UTE	Schuko/UTE	Schuko/UTE	Schuko/UTE	Schuko/UTE	Schuko/UTE	
Cable retention method	Cable clamp + guide	Cable clamp + guide	Cable clamp + guide	Cable clamp + guide	Cable clamp + guide	Cable clamp + guide	Cable clamp + guide	Cable clamp + guide	Cable clamp + guide
Number and type of outlets*	6 German	9 German	6 French/Belgian	6 French/Belgian	6 German	6 French/Belgian	6 German	6 German/Italian	6 C13 with locking
Outlet colour	Black	Black	Black	Black	Black	Black	Black	Black	Black
Angle of outlets	55°	55°	55°	55°	55°	55°	55°	90°	90°
Number of circuits per phase	1	1	1	1	1	1	1	1	1
Additional functions	1P MCB C16 6 kA Cat.No. 4 136 06	1P MCB C16 6 kA Cat.No. 4 136 06	1P RCBO C16 6 kA 30 mA AC type C curve Cat.No. 4 107 05	Surge protection module Luminous switch	Surge protection module Luminous switch	Ammeter	Ammeter	Ammeter	Ammeter
Casing	1U aluminium	2x1U aluminium	1U aluminium	1U aluminium	1U aluminium	1U aluminium	1U aluminium	1U aluminium	1U aluminium
Fixings (included)	19" reversible bracket + snap-on fixing								

\* Outlets are equally distributed on each vertical PDU circuit

\*\* Maximum capacity of terminal block 6 mm<sup>2</sup>

**10" PDUs**  
**19" PDUs**  
**Zero-U PDUs**

**Cat. Nos: 6 468 00/01/05/06/07/09/10/11/12/13/14/15/18/19/20/21/22/23/24/30/31/32/33/35/36/40/41/42/43/44/45/50/51/52/53/54/56/57/59/60/61/65/70/75/90/92/94/95/97/98/99**

19" PDUs (continued)

	<b>6 468 44</b>	<b>6 468 45</b>	<b>6 468 99</b>
Number of phases	1	1	1
Input voltage	230 V	230 V	230 V
Input current	16 A	16 A	16 A
Maximum power	3.7kW	3.7kW	3.7kW
Termination method	Terminal block**	Terminal block**	
Cable length			
Cable material			
Cable cross-section			
Plug type			
Cable retention method	Cable clamp + guide	Cable clamp + guide	
Number and type of outlets*	6 C19 with locking	6 C13 + 1 C19 with locking	
Outlet colour	Black	Black	
Angle of outlets	90°	90°	
Number of circuits per phase	1	1	
Additional functions	Ammeter	Ammeter	
Casing	1U aluminium	1U aluminium	Zero-U aluminium
Fixings (included)	19" reversible bracket + snap-on fixings		

\* Outlets are equally distributed on each vertical PDU circuit

\*\* Maximum capacity of terminal block 6 mm<sup>2</sup>

Zero-U PDUs

	<b>646850</b>	<b>646851</b>	<b>646852</b>	<b>646853</b>	<b>646854</b>	<b>646856</b>
Number of phases	1	1	1	1	1	1
Input voltage	230 V	230 V	230 V	230 V	230 V	230 V
Input current	32 A	32 A	32 A	32 A	32 A	32 A
Maximum power	7.4kW	7.4kW	7.4kW	7.4kW	7.4kW	7.4kW
Termination method	Terminal block**	Cord	Terminal block**	Cord	Terminal block**	Terminal block**
Cable length		3 m		3 m		
Cable material		Rubber HO7RNF		Rubber HO7RNF		
Cable cross-section		3G 4		3G 4		
Plug type		IEC 60309 32 A 2P+E		IEC 60309 32 A 2P+E		
Cable retention method	Cable clamp + rotatative system	Cable clamp + rotatative system	Cable clamp + rotatative system	Cable clamp + rotatative system	Cable clamp + rotatative system	Cable clamp + rotatative system
Number and type of outlets*	24 French/Belgian	24 French/Belgian	24 German	24 German	24 UK	24 C13 with locking
Outlet colour	Black	Black	Black	Black	Black	Black
Angle of outlets	55°	55°	55°	55°	55°	90°
Number of circuits per phase	2	2	2	2	2	2
Identification of circuits (colour-code)	Blue/Red	Blue/Red	Blue/Red	Blue/Red	Blue/Red	Blue/Red
Additional functions	1P+N MCB C16 10 kA Cat.No. 4 077 00	1P+N MCB C16 10 kA Cat.No. 4 077 00	1P+N MCB C16 10 kA Cat.No. 4 077 00	1P+N MCB C16 10 kA Cat.No. 4 077 00	1P+N MCB C16 10 kA Cat.No. 4 077 00	1P+N MCB C16 10 kA Cat.No. 4 077 00
Casing	Zero-U aluminium	Zero-U aluminium	Zero-U aluminium	Zero-U aluminium	Zero-U aluminium	Zero-U aluminium
Fixings (included)	2 button + 2 standard brackets, 2 Minkels brackets + 2 screws					

\*\* Maximum capacity of terminal block 6 mm<sup>2</sup>

**10" PDUs**  
**19" PDUs**  
**Zero-U PDUs**

**Cat. Nos: 6 468 00/01/05/06/07/09/10/11/12/13/14/15/18/1  
9/20/21/22/23/24/30/31/32/33/35/36/40/41/42/43/44/  
45/50/51/52/53/54/56/57/59/60/61/65/70/75/90/92/94/  
95/97/98/99**

Zero-U PDUs (continued)

	<b>646857</b>	<b>646859</b>	<b>646860</b>	<b>646861</b>	<b>646865</b>	<b>646870</b>
Number of phases	1	1	1	1	1	3
Input voltage	230 V	230 V	230 V	230 V	230 V	400 V
Input current	32 A	32 A	32 A	32 A	32 A	16 A
Maximum power	7.4kW	7.4kW	7.4kW	7.4kW	7.4kW	11kW
Connection method	Cord	Cord	Terminal block**	Cord	Terminal block**	Cord
Cable length	3 m	3 m		3 m		3 m
Cable material	Rubber HO7RNF	Rubber HO7RNF		Rubber HO7RNF		Rubber HO7RNF
Cable cross-section	3G 4	3G 4		3G 4		5G 2.5
Plug type	IEC 60309 32 A 2P+E	IEC 60309 32 A 2P+E		IEC 60309 32 A 2P+E		IEC 60309 16 A 3P+N+E
Cable retention method	Cable clamp + rotative system	Cable clamp + rotative system	Cable clamp + rotative system	Cable clamp + rotative system	Cable clamp + rotative system	Cable clamp + rotative system
Number and type of outlets*	24 C13 with locking	24 German/Italian	20 C13 + 4 C19 with locking	20 C13 + 4 C19 with locking	20 C13 + 4 C19 with locking	18 C13 + 6 C19 with locking
Outlet colour	Black	Black	Black	Black	Black	Black
Angle of outlets	90°	90°	90°	90°	90°	90°
Number of circuits per phase	2	2	2	2	2	1
Identification of circuits (colour-code)	Blue/Red	Blue/Red	Blue/Red	Blue/Red	Blue/Red	
Additional functions	1P+N MCB C16 10 kA Cat.No. 4 077 00	1P+N MCB C16 10 kA Cat.No. 4 077 00	1P+N MCB C16 10 kA Cat.No. 4 077 00	1P+N MCB C16 10 kA Cat.No. 4 077 00	1P+N MCB C16 10 kA Cat.No. 4 077 00 1 ammeter per circuit	1P MCB C16 10 kA Cat.No. 4 076 54
Casing	Zero-U aluminium	Zero-U aluminium	Zero-U aluminium	Zero-U aluminium	Zero-U aluminium	Zero-U aluminium
Fixings (included)	2 button + 2 standard brackets, 2 Minkels brackets + 2 screws					

	<b>646875</b>
Number of phases	3
Input voltage	400 V
Input current	16 A
Maximum power	11kW
Connection method	Cord
Cable length	3 m
Cable material	Rubber HO7RNF
Cable cross-section	5G 2.5
Plug type	IEC 60309 16 A 3P+N+E
Cable retention method	Cable clamp + rotative system
Number and type of outlets*	18 C13 + 6 C19 with locking
Outlet colour	Black
Angle of outlets	90°
Number of circuits per phase	1
Identification of circuits (colour-code)	
Additional functions	1P MCB C16 10 kA Cat.No. 4 076 54 1 ammeter per circuit
Casing	Zero-U aluminium
Fixings (included)	2 button + 2 standard brackets, 2 Minkels brackets + 2 screws

\* Outlets are equally distributed on each circuit

\*\* Maximum capacity of terminal block 6mm<sup>2</sup>

■ 2.2 Customized products

Legrand PDUs can be delivered with custom configurations to meet specific customer requirements. Contact your local sales representative to discuss your requirements.

↓ CONFIGURATION EXAMPLES

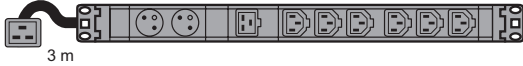

Example:  
19" PDU 1U with 2 x 2P+E French/Belgian standard outlets, 1 C19 socket and 6 C13 sockets.  
Supplied with 3 m cable and C20 plug

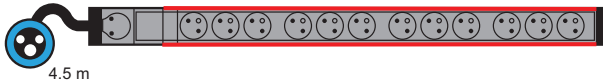

Example:  
Zero-U PDU with 12 2P+E French/Belgian standard outlets.  
Red strips for PDU identification purposes. Supplied with rotative cable entry, 4.5 m cable and IEC 60309 16 A plug

3. FUNCTIONS

■ 3.1 Outlets

Legrand PDUs can be equipped with outlets of different standards.

**C13 with cord locking system**

2P+E 10 A  
Outlet recess at 90° angle  
Conforms to standard IEC 60320-2-2

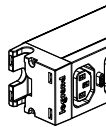

**C19 with cord locking system**

2P+E 16 A  
Socket recess at 90° angle  
Conforms to standard IEC 60320-2-2

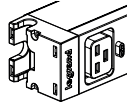

**Cord locking system on C13/C19 sockets**

The cord is locked mechanically into the outlet to prevent any unintended disconnection (caused by maintenance, vibrations, etc.).  
Pull-out force > 100 N

This universal solution is compatible with all standard cords available on the market.

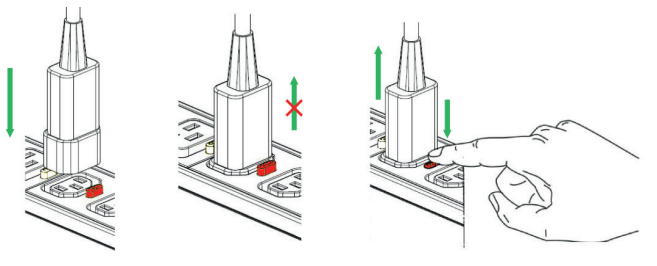

**French-Belgian**

2P+E 16 A  
Terminals equipped with protective shutters  
Outlet recess at 55° angle  
Conforms to standard IEC 60320-2-2

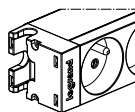

**German**

2P+E 16 A  
Terminals equipped with protective shutters  
Outlet recess at 55° angle  
Conforms to standard IEC 60320-2-2

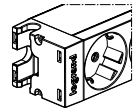

**UK**

2P+E 13 A  
Terminals equipped with protective shutters  
Outlet recess at 90° angle  
Conforms to standard IEC 60320-2-2

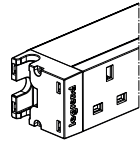

■ 3.2 LED switch

The LED switch is used to control the PDU power supply.  
A white LED is lit when the PDU sockets are supplied with power.

16 A switch  
Transparent switch

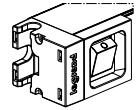

■ 3.3 Power indicator

A white LED on the power indicator shows that the product is supplied with power.

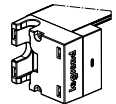

■ 3.4 Ammeter

The ammeter is used to measure consumption for enhanced installation management.

Operation: 230 VAC 50Hz  
Measured value: current (0 to 32 A)  
Operates by measuring the current using a shunt  
3-digit display "XX.X"

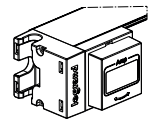

Rotatable display for legible readout regardless of whether the PDU is mounted vertically or horizontally

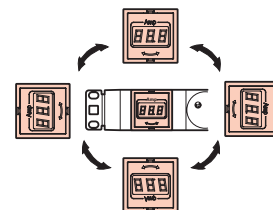
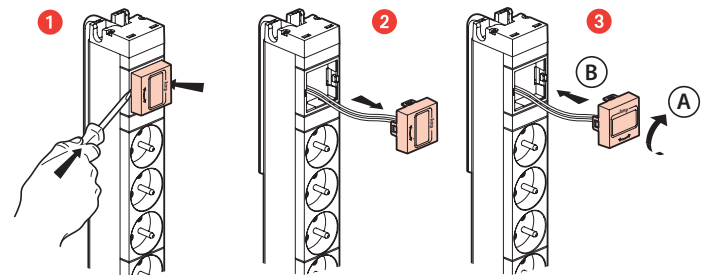



### ■ 3.5 Surge protection and replacement module

Protection between Line and neutral of socket outlets connected downstream against overloads generated by the electrical network upstream of the surge protective device by creating a discharge current on the network and/or earthing link.

To be used in combination with a voltage surge protector installed in the panel..

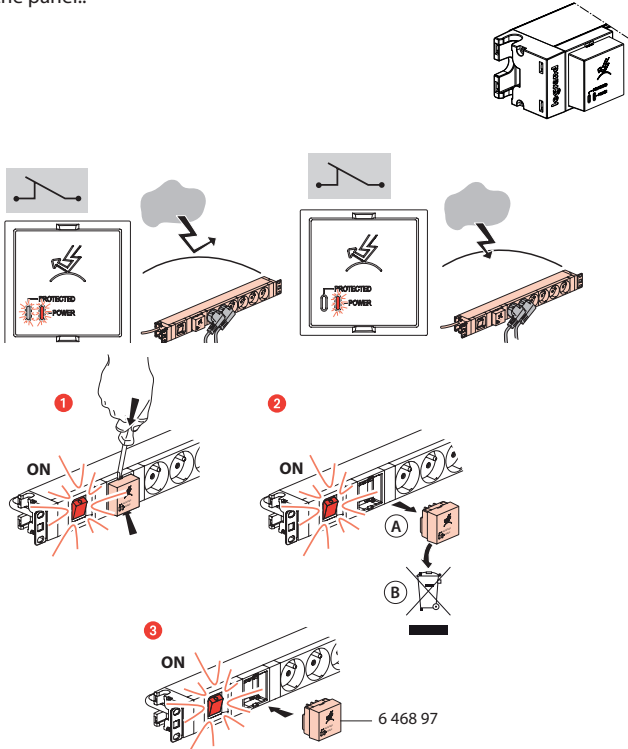

#### Operation

- Surge protective devices are designed to limit transient overvoltages of atmospheric and industrial origin.
- They have a certain capacity to absorb energy and age with each operation; it is therefore normal for them to be out-of-order after a certain number of operations. The imminent out-of-order status is signalled and the draw-out module should be replaced.
- Surge protective devices are designed to be installed at use points and are to be used in combination with the installation's original modular protection.
- They are not designed to provide sole protection for an installation in a building likely to be hit by direct lightning strikes (e. g. buildings equipped with lightning arresters). This would immediately put the device out-of-order by exceeding its maximum discharge capacity.
- Overloads of atmospheric origin occur between the active wires and the earth. They are highly charged and uncontrolled.
- Overloads of industrial origin occur between the active wires (L+N) and are not so highly charged.
- The surge protective devices are equipped with an operation indicator light (to be checked on a regular basis):
  - Mains supply present and green indicator light on: operational protection.
  - Mains supply present and red indicator light on: change the module.
  - Once the draw-out module is out-of-order the installation is no longer protected but remains powered (including the withdrawn module).

#### Technical data

Number of poles		2
Neutral system		TT - TNS
Mode of protection		MCB C16 and/or MCBO 300mA
Maximum continuous operating voltage	U <sub>c</sub>	LN & N/PE 255V L/PE 440V
Nominal system voltage	U	230 VAC
Assigned current of load	I <sub>L</sub>	16A
Frequency	F	50/60 Hz
Open circuit voltage	U <sub>oc</sub>	10 kV
Voltage protection level	U <sub>P</sub>	L/N 1kV L/PE & N/PE 1,2kV
Temporary overvoltage test value	U <sub>T</sub>	441V
Nominal discharge current	I <sub>n</sub>	5kA
Maximum discharge current	I <sub>max</sub>	10 kA
Current factor k		1.6
Type		Type 2 (T2) _ Type 3 (T3)
Location		Indoor
Temperature and humidity range		Normal range : -5°C : +40°C

#### Mechanical characteristics

IP 20

#### Cleaning

Without cleaning

Replaceable element: Cassette Reference 6 468 9

#### Conformity

In compliance with the standard NF EN 61643-11 : 2014

■ 3.6 Protection devices

Protection devices are integrated in all standard catalogue PDUs and customized PDUs.

- MCBs

For protecting equipment against short-circuits and overloads

- 407652 DX3 1P MCB 10 A 6000 A - 10 kA
- 407654 DX3 1P MCB 16 A 6000 A - 10 kA
- 409131 DX3 1P MCB 10 A 10000 A - 16k A
- 409133 DX3 1P MCB 16 A 10000 A - 16 kA
- 407698 DX3 1P+N MCB 10 A 6000 A - 10 kA
- 407700 DX3 1P+N MCB 16 A 6000 A - 10 kA
- 409150 DX3 1P+N MCB 10 A 10000 A - 16 kA
- 409152 DX3 1P+N MCB 16 A 10000 A - 16 kA

- RCBOs

For protecting equipment against short-circuits and overloads and protecting people against leakage currents

- 410704 RCBO 10 A ACTYPE 4500 A - 6 kA - 30 mA
- 410705 RCBO 16 A ACTYPE 4500 A - 6 kA - 30 mA
- 410752 RCBO 10 A HPi ACTYPE 4500 A - 6 kA - 30 mA
- 410753 RCBO 16 A HPi ACTYPE 4500 A - 6 kA - 30 mA

See section 2 "Equipment and performance" to see which protection device is integrated in the standard catalogue products.

MCBs and RCBOs are installed on a projecting DIN rail support to avoid unintended breaking. This support can be equipped with a transparent cover by special request.

1 or 2-module support depending on the catalogue number

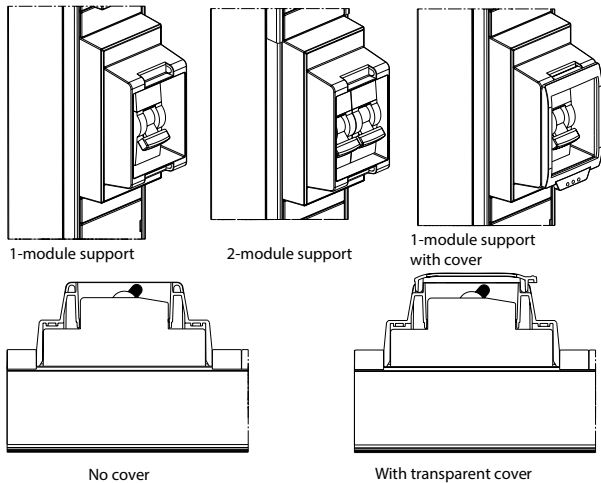

■ 3.7 Fuse (custom configured version)

For protecting equipment against short-circuits and overloads

Cartridge rating: 10 A and 16 A

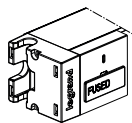

To replace the cartridge, use a screwdriver to lever open the compartment containing the fuse.

■ 3.8 Thermal overload breaker (custom configured version)

For protecting equipment against short-circuits and overloads

Rating: 10 A and 16 A

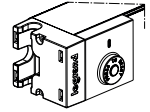

Reset: The LED is lit during operation. When there is an overload, the red button pops out of the module and the LED goes off. To reset the breaker, press the red button until it clicks back into position; the LED lights up again.

3.9 Colour-coding

The PDUs are colour-coded using coloured strips.

These strips clip onto the edge of the aluminium casing.

This solution is only compatible with Zero-U PDUs.

Extruded PVC plastic

Blue and red borders are available as standard, other colours are available on request.

2 applications:

- For identifying circuits: one colour per circuit, to match the same colour used on the circuit breaker



- For identifying the source: whole PDU in one colour identifies whether it is the primary or interruptible power source when there are 2 PDUs in the rack

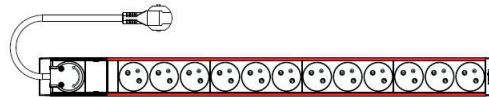

**10" PDUs**  
**19" PDUs**  
**Zero-U PDUs**

Cat. Nos: 6 468 00/01/05/06/07/09/10/11/12/13/14/15/18/19/  
 20/21/22/23/24/30/31/32/33/35/36/40/41/42/43/44/  
 45/50/51/52/53/54/56/57/59/60/61/65/70/75/90/92/94/  
 95/97/98/99

**3.10 Locking caps**

For locking out the use of a socket.

Require a key to unlock access.

Products comprise a set of 6 locking caps + 1 key.

Cat.No 646890: For French/Belgian, German and Italian standard sockets (P40)

Cat.No 646892: For UK standard sockets

Cat.No 646894: For C13 standard sockets

Cat.No 646895: For C19 standard sockets

ABS plastic

Light grey RAL 7035

Operating principle

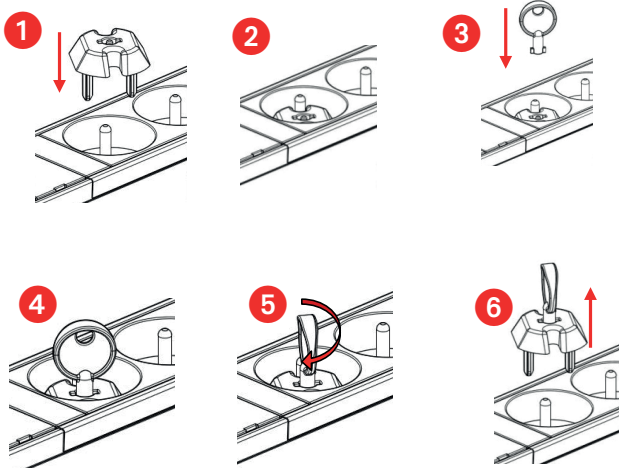

**4.1 10" PDU**

All 10" catalogue numbers excluding 6 468 98

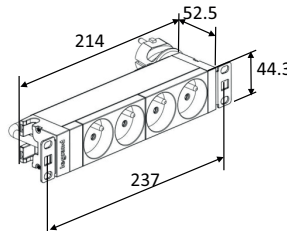

To be equipped catalogue number 6 468 98

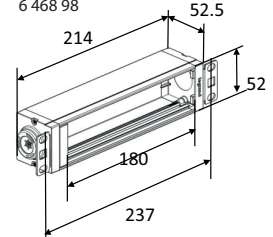

**4.2 19" PDU**

All 19" catalogue numbers excluding 6 468 99

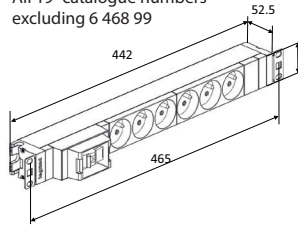

To be equipped catalogue number 6 468 99

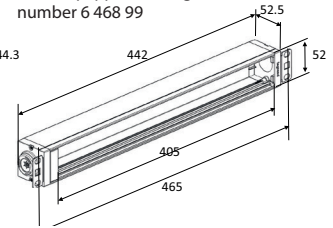

**4.3 ZERO-U PDU**

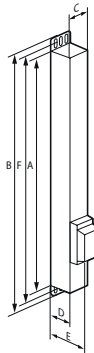

Cat. No	Height		Width	Depth			Fixing centres (min.-max.)
	A	B <sup>(1)</sup>		C	D	E <sup>(2)</sup>	
6 468 50	1250	1294	52	52.5	87		1262-1292
6 468 51	1250	1294	52	52.5	87		1262-1292
6 468 52	1250	1294	52	52.5	87		1262-1292
6 468 53	1250	1294	52	52.5	87		1262-1292
6 468 54	1466	1510	52	52.5	87		1478-1508
6 468 56	1034	1078	52	52.5	87		1046-1076
6 468 57	1034	1078	52	52.5	87		1046-1076
6 468 60	1070	1114	52	52.5	87		1082-1112
6 468 61	1070	1114	52	52.5	87		1082-1112
6 468 65	1160	1204	52	52.5	87		1172-1202
6 468 70	1340	1384	52	52.5	87		1352-1382
6 468 75	1475	1519	52	52.5	87		1487-1517

1: Total height with standard bracket (screw-fixing)  
 2: Total depth at circuit breaker slot

**4. DIMENSIONS**

## 5. INSTALLATION

### 5.1 TERMINATION

Depending on the configuration, the PDUs can be connected in different ways.

#### 1) Supplied with power cord

See section 2 "Equipment and performance" to see which standard catalogue products have an integrated cord.

#### 2) Terminal block connection

Some products are supplied without a cable; they are designed to be wired on a terminal block.

See section 2 "Equipment and performance" to see which standard catalogue products have an integrated terminal block.

Example of terminal block connection for a Zero-U PDU with rotative cable entry

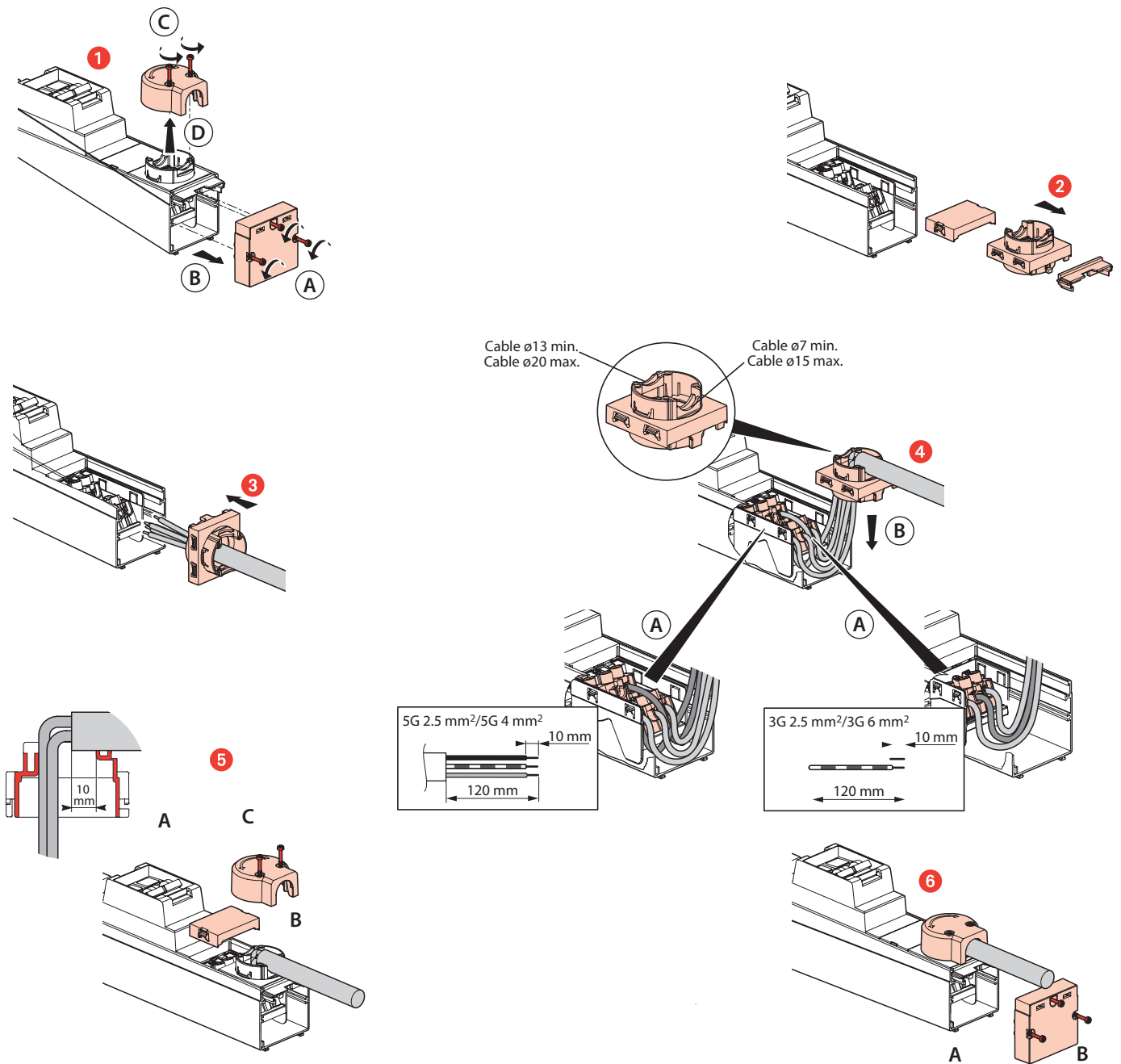

**3) Connection via fast connector or C20 connector (custom configured version)**

Connectors mounted on the front panel of the PDU. The PDU is powered via a separate cable that plugs into these connectors.

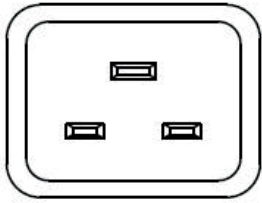

C20

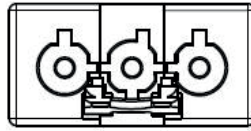

Wieland GST18

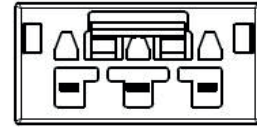

Wago

	C20	Wieland GST18	Wago
Type	Male	Female	Female
Nominal current	16 A	16 A	25 A
Voltage	250 VAC	250 VAC	250 VAC
IP	20	20	20

**4) Explanation of 19" cable entry, rotative cable input, input with cable gland**

The end piece on 19" PDUs integrates a cable guide.

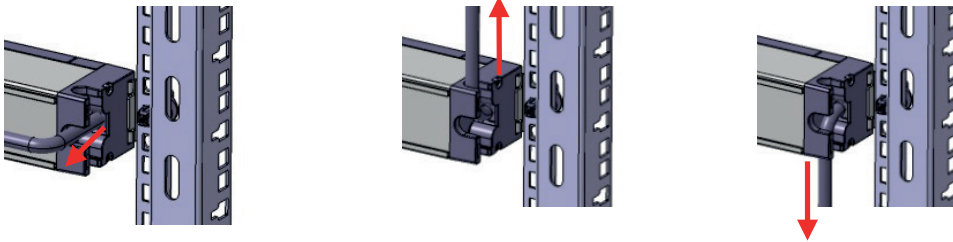

Zero-U PDUs integrate a rotative cable input (330°).

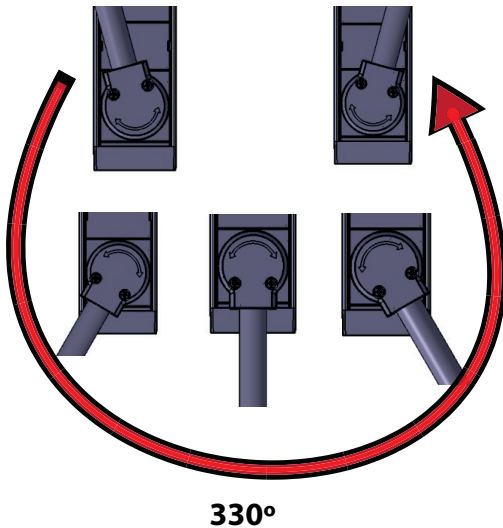

PDUs can be supplied with a cable input via cable gland by special request (input on front face or on the end).

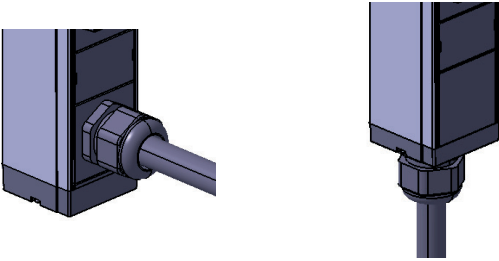

**5.2 MOUNTING SOLUTIONS**

**1) 10" and 19"**

Horizontal mounting with snap-on fixing (for square holes 9.5 x 9.5).  
 Snap-on fixing system included

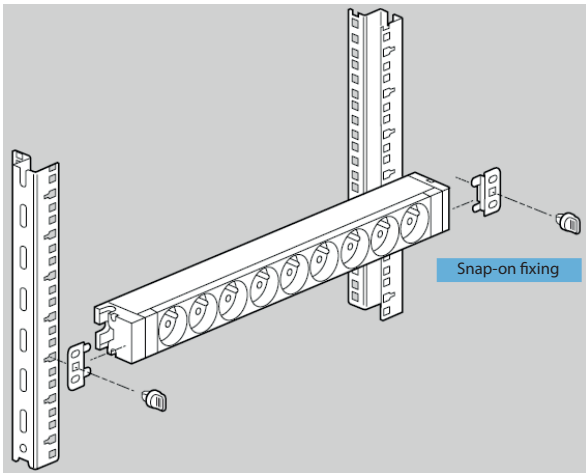

Vertical mounting possible by turning the fixing brackets round and positioning them on the rear of the unit.

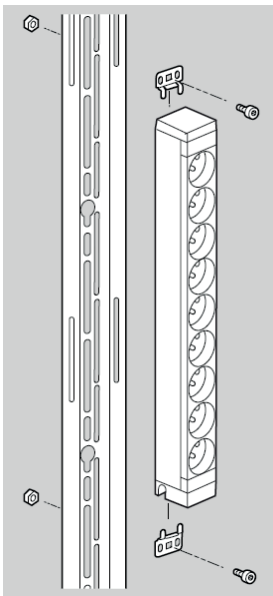

Mounting bracket dimensions

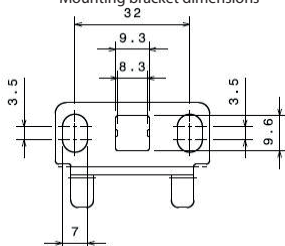

**2) Zero-U**

Zero-U PDUs are designed for vertical installation and supplied with 2 sets of fixing accessories:

- 2 button: for screwless fixing. The height of the fixing centre can be set at any point along the full height of the PDU by sliding the button slots into the groove on the rear of the PDU. Tightened using a 2.5 mm Allen key.

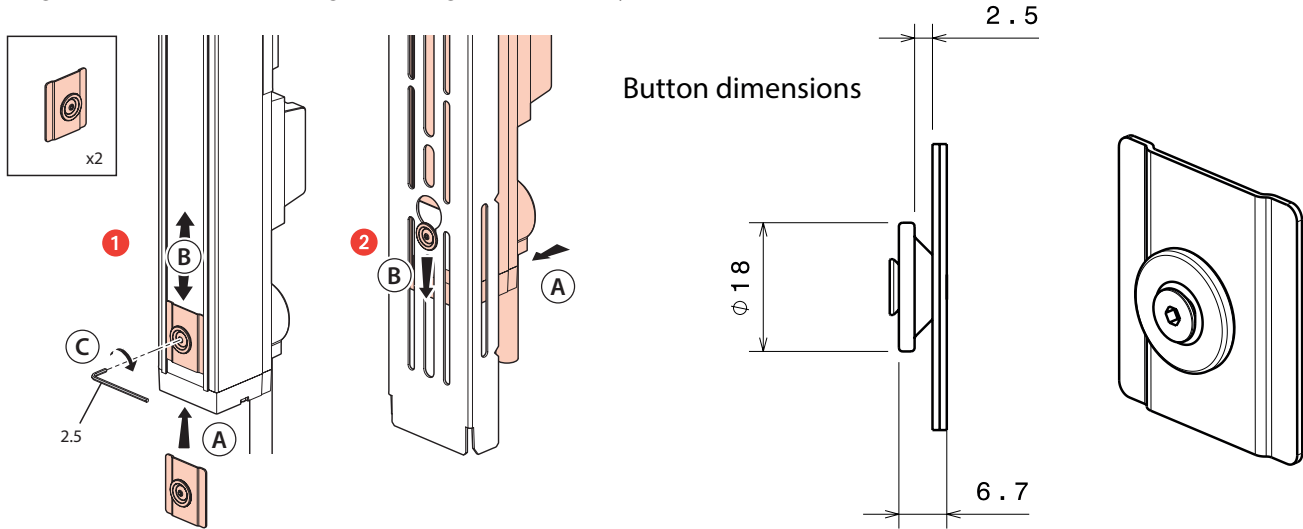

- 2 standard fixing brackets: for screw-fixing (screws not included)

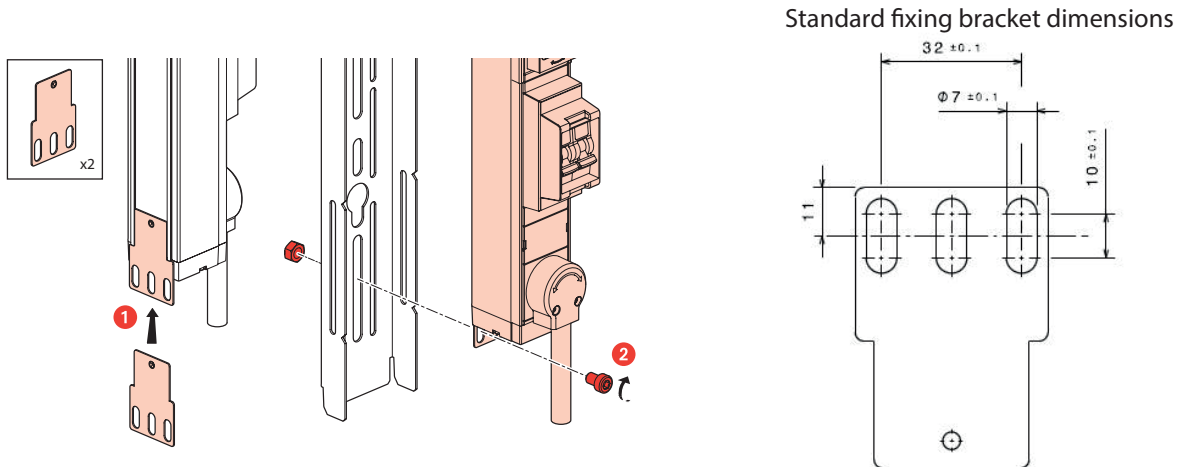

- 2 Minkels brackets + 2 screws

