

<p>12-15 V $\overline{\text{---}}$</p>	<p>MONO 1 x 1 W STEREO 2 x 1 W</p>	<p>87,5 MHz ↓ 108 MHz</p>	<p>10 max.</p>

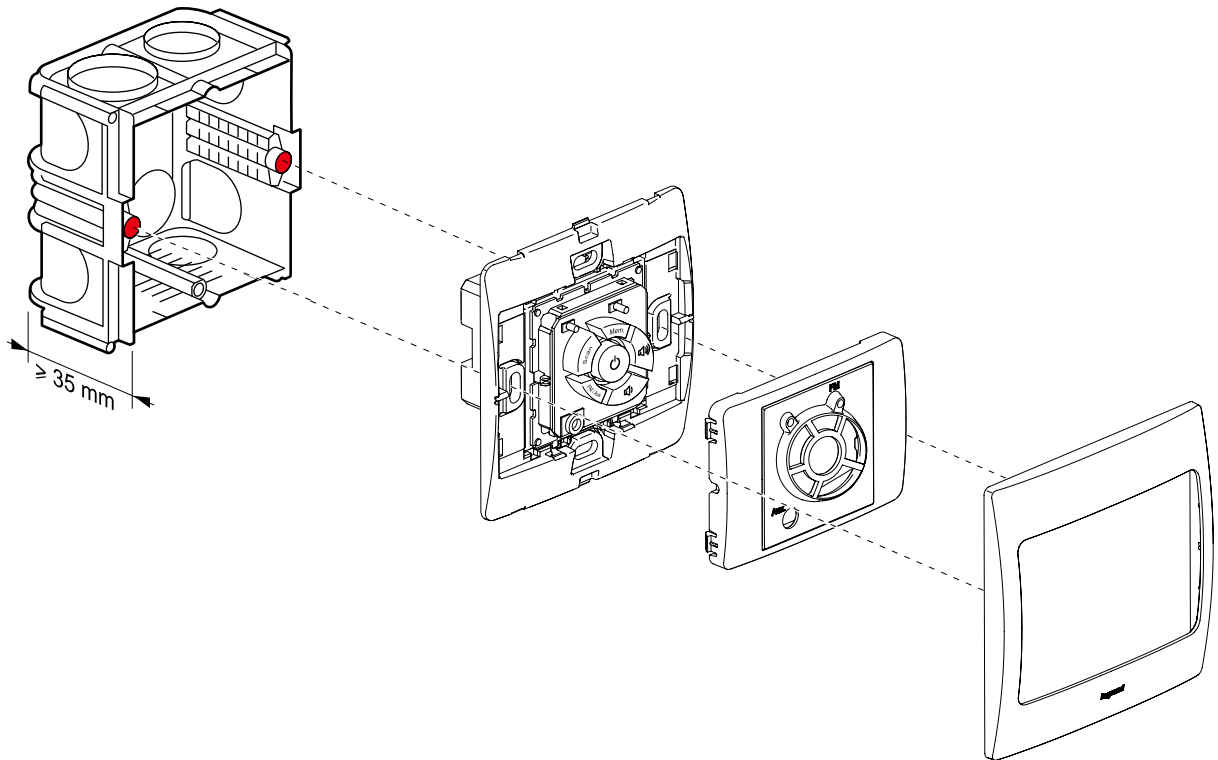

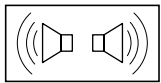

STEREO

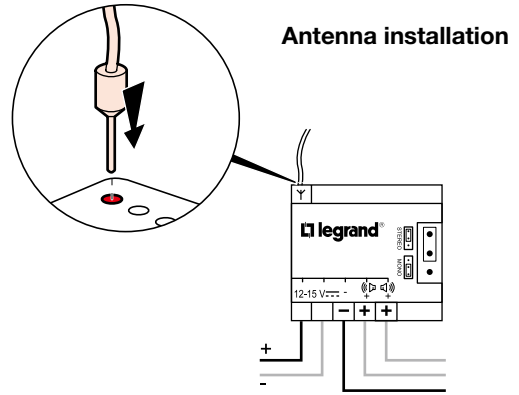
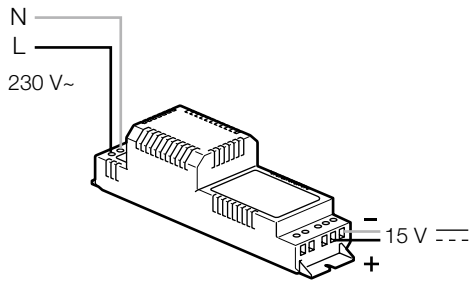
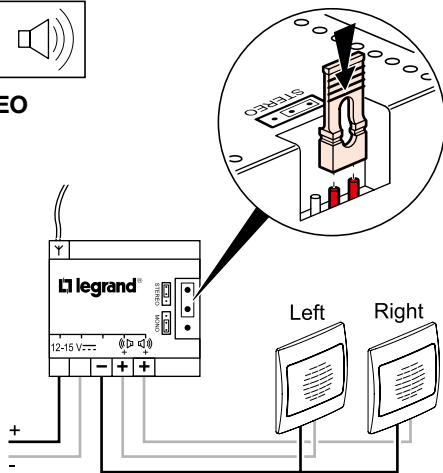

MONO

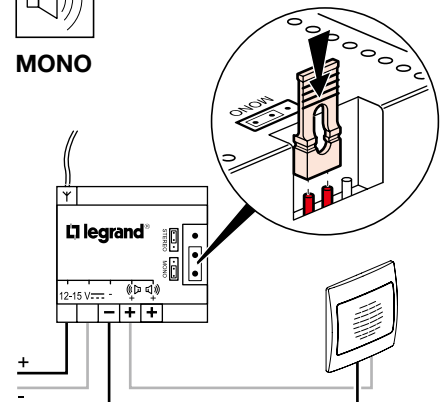

0 / I

ON/OFF

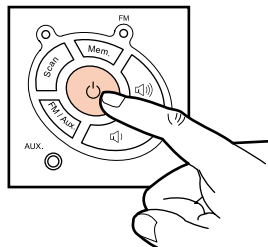

FM / AUX.

Select FM/AUX.

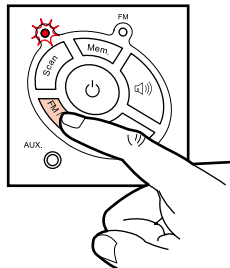

⇒ FM

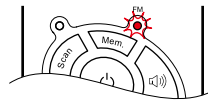

⇒ AUX.

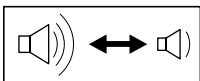
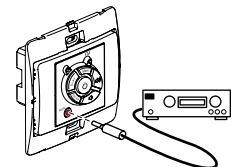
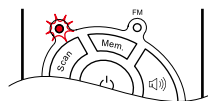

Adjust Volume

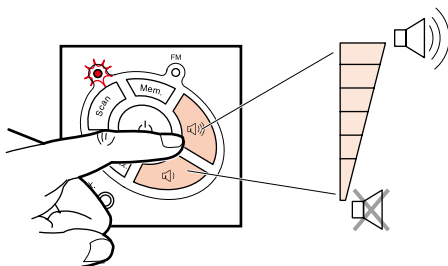

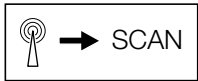

Search FM

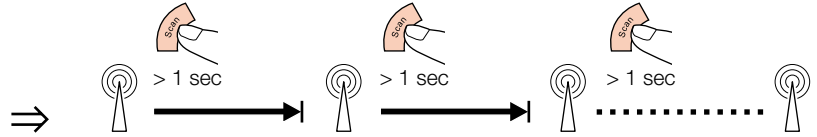
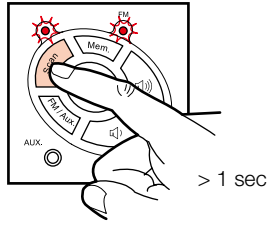
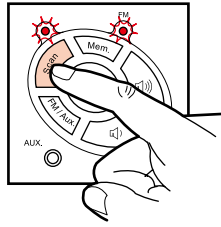

Memory FM

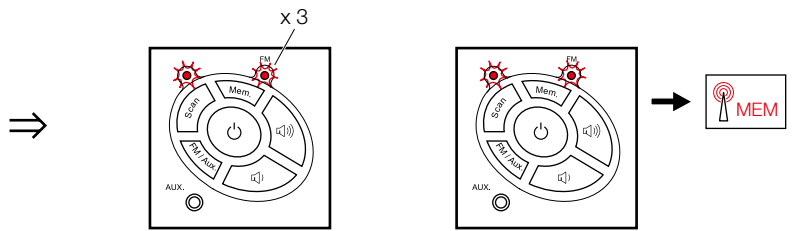
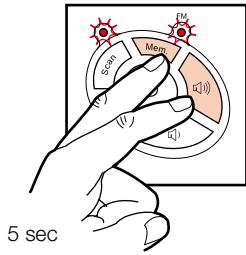

Auto search & memory FM

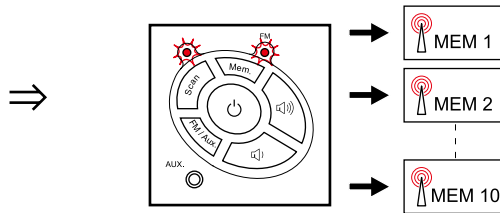
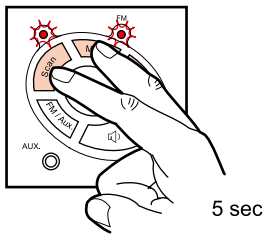

Select Memory

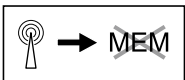
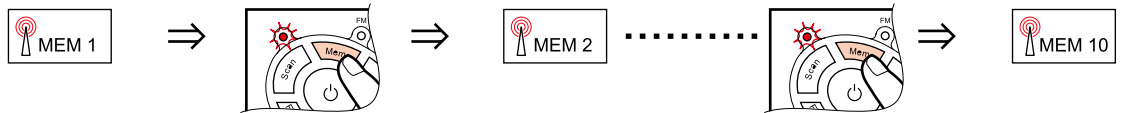

Delete Memory

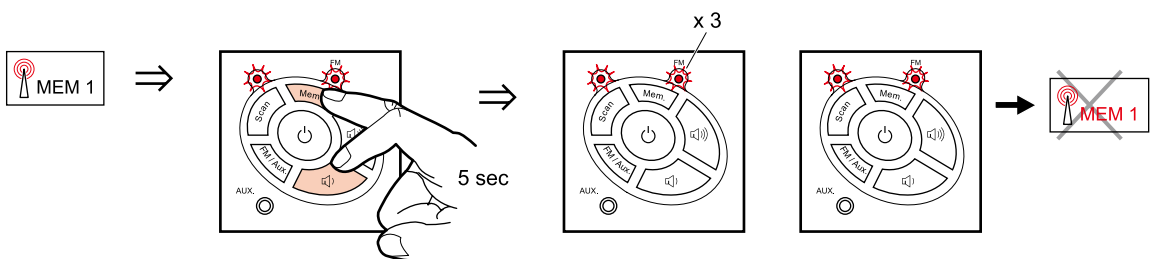



Adjust Sensitivity

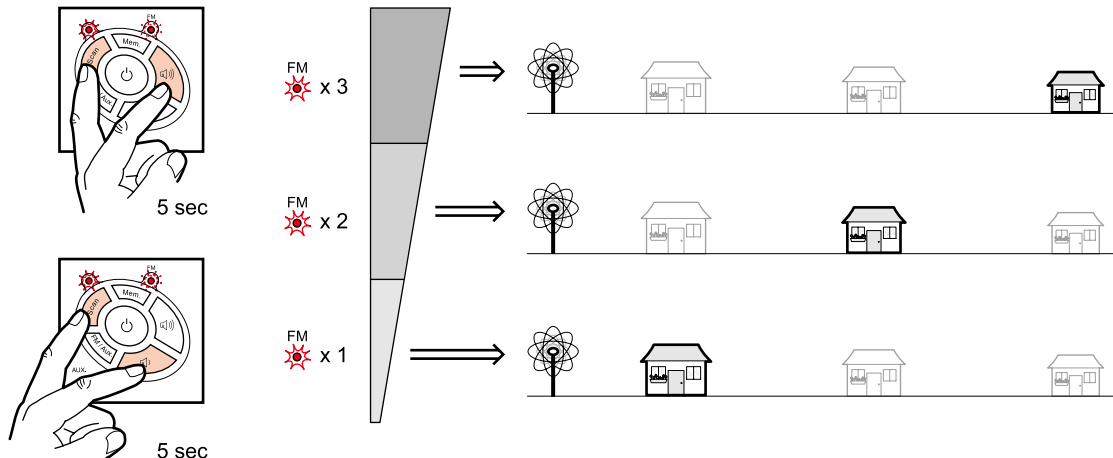

• If despite the settings the quality of reception remains bad, please contact us.

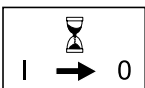

Sleep Time

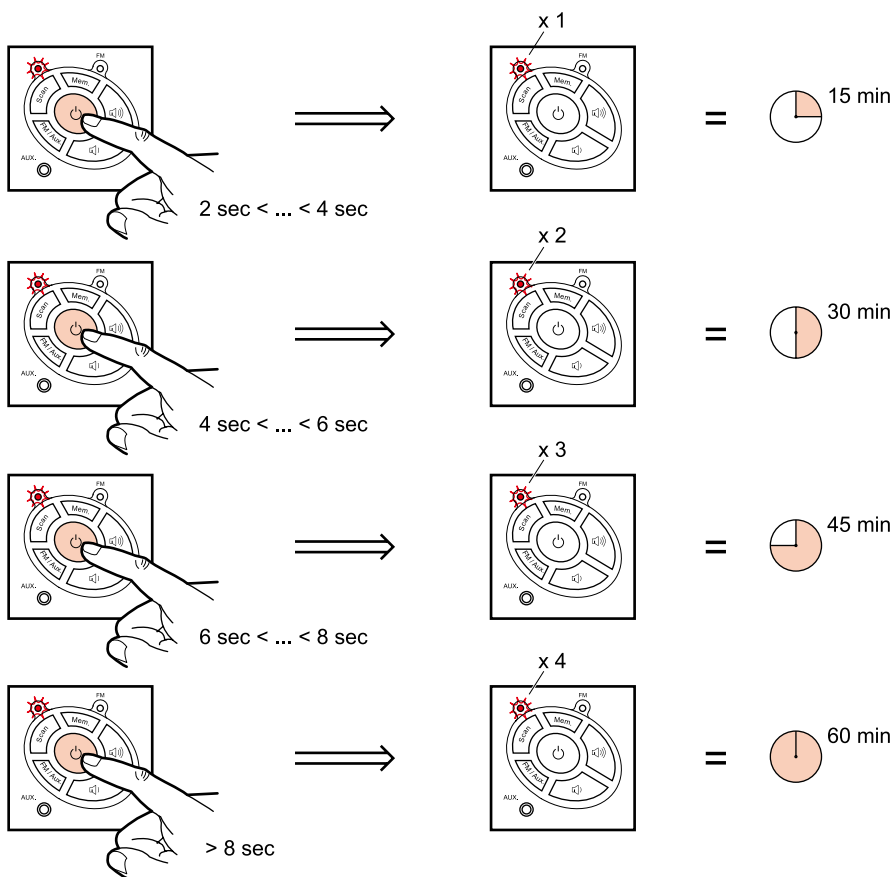

Safety instructions

This product should be installed preferably by a qualified electrician. Incorrect installation and use can entail risk of electric shock or fire. Before carrying out the installation, read the instructions and take account of the product's specific mounting location.

Do not open up the device. All Legrand products must be exclusively opened and repaired by personnel trained and approved by LEGRAND. Any unauthorised opening or repair completely cancels all liabilities and the rights to replacement and guarantees. Only use genuine accessories.