

BUS-SCS external indicator display panel

Cat. No(s): 0 487 75/85
FL4650/50W/60

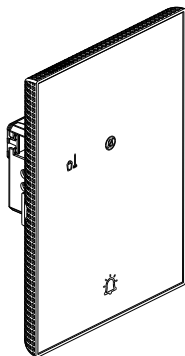

CONTENTS	Page
1. Description	1
2. Technical characteristics	1
3. Standards, certifications and marks	1
4. Dimensions	1
5. Door bell connection diagrams	2
6. Installation	2
7. Configured version Cat. No. 0 487 85/ FL4660	3

1. DESCRIPTION

This is an indicator display panel located outside the room (in the corridor) displaying the housekeeping information:

- Do Not Disturb
- Make Up Room
- Extra service (for example Pick up laundry) (only on configured version Cat. No. 0 487 85/FL4660)

It also has a "call bell" touch-sensitive button which flashes for 3 s to show that the command has been recognised.

The "call bell" indicator status shows whether anyone is in the room: on if someone present, off if no one present.

If the DND function is enabled, the "call bell" relay is disabled. When pressed, the DND LED flashes, but the "call bell" indicator does not flash.

Alarms are signalled by the flashing "call bell" indicator. This visual alarm function is only available for SCS installations which include the MH201 device, and can be configured with the MyHotel_Suite software available on the website www.homesystems-legrandgroup.com.

This product is also available for IP installations which include controller Cat. Nos. 0 484 08/12, and can be configured with the Hotel Room Configuration Software available on the website www.legrandoc.com.

2. TECHNICAL CHARACTERISTICS

BUS/SCS power supply:	18 - 27 VDC
Standby consumption:	6 mA
On-load consumption:	8 mA max
Relay contact (activated by button on the front):	230 VAC max 1 A max
Operating temperature:	0°C to +40°C
Storage temperature:	-20°C to +70°C
Protection index:	IP 20, IK 04
Plate and wall box colour (standard):	Black Cat. No. 0 487 75/FL4650 or white Cat. No. FL4650W

3. STANDARDS, CERTIFICATIONS AND MARKS

EN 60669-2-5
CE marked

4. DIMENSIONS

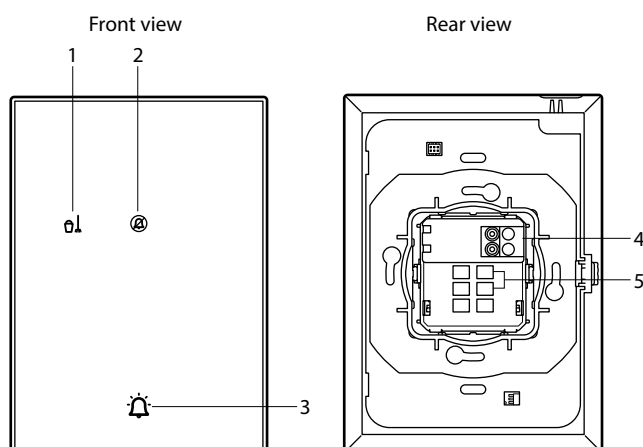

Key

1. MUR indicator (green LED on = MAKE UP ROOM)
2. DND indicator (red LED on = DO NOT DISTURB)
3. Door bell call indicator
4. BUS/SCS plug-in connector
5. NO contact for activating the door bell. The contact is controlled by pressing the "door bell" indicator.

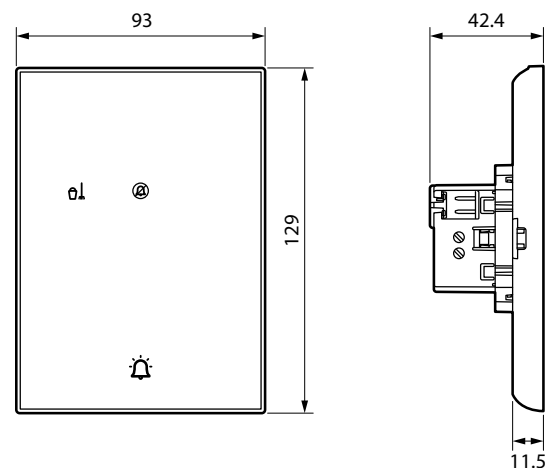

5. DOOR BELL CONNECTION DIAGRAMS

The "call bell" relay is active for as long as the device button is pressed.

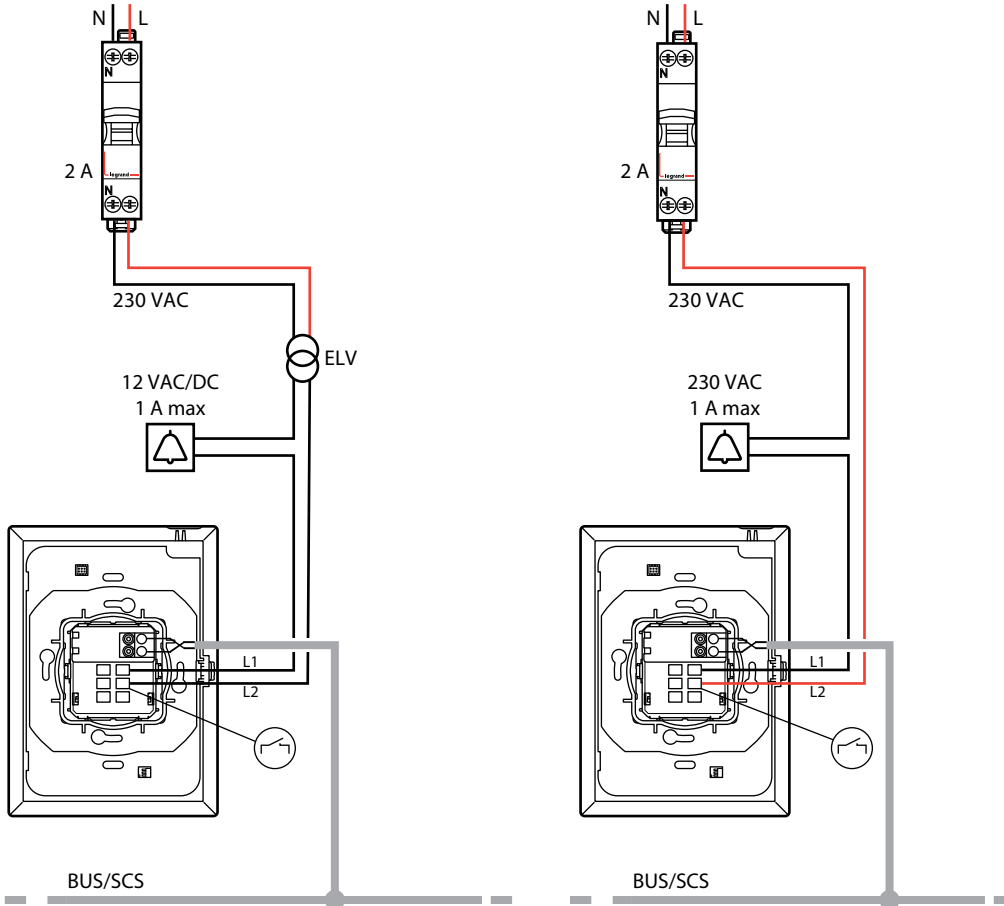

6. INSTALLATION

Surface-mounted with flush-mounting boxes

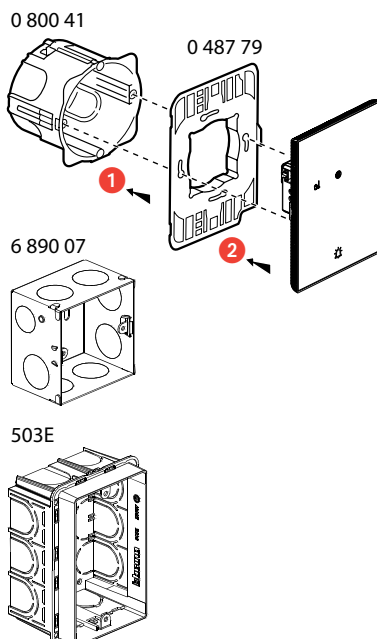

Flush-mounted with accessory
Cat. No. 0 487 88

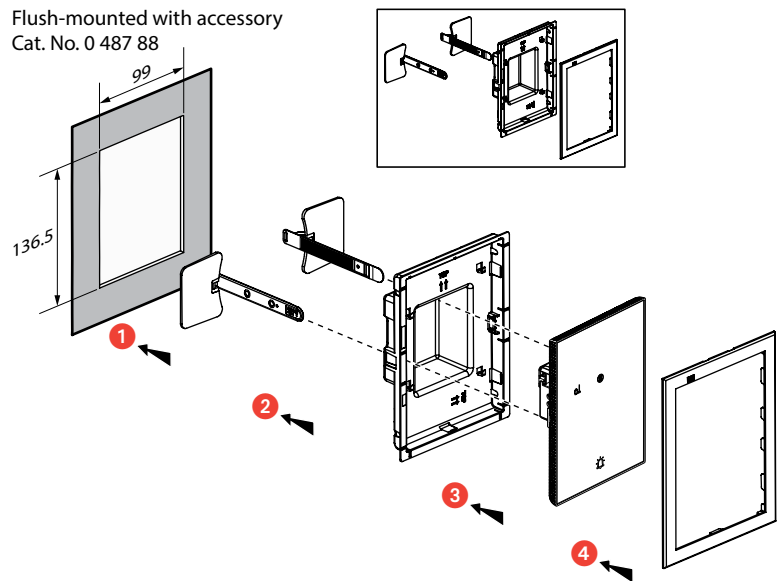

7. CONFIGURED VERSION CAT. NO. 0 487 85/FL4660

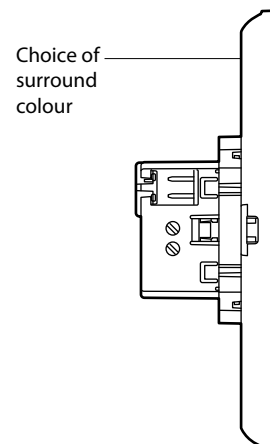
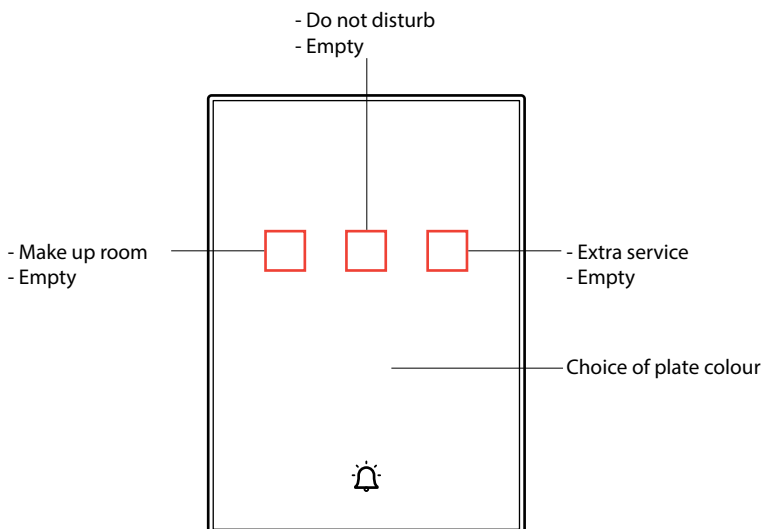

- Options (predefined position):
- Hotel logo
 - Room no. (alphanumeric)
 - Flush-mounted version

The configurator is available on the following website: www.uxforupscalehotel.legrand.com.
The list of pictogram and colour options (plate and surround) can be accessed via the configurator.