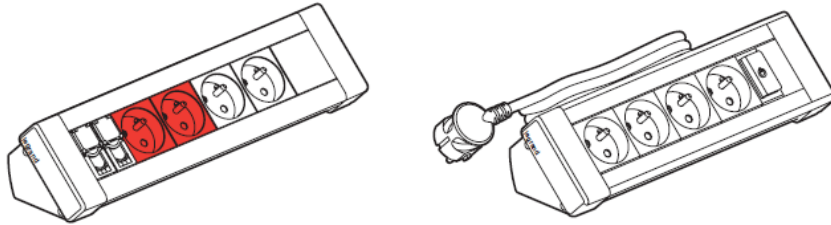

Desktop multi-outlets new design

Number(s) :

 0 535 98- 0 546 00/01/15/16/20/21/25/26/27/28/29/31/33/35/36/37/
 90/91/92/99 - 6 535 60 à 63

CONTENTS

PAGES

1 Range	1 to 2
2 On demand	3
3 Technical characteristics	3 to 5
4. Material characteristics	5

1. RANGE

Desktop multi-outlets :

- an ideal solution dedicated to nomadic people and/or satisfy a aesthetic needs.
- products answering all needs (pre-wired, to wire, empty or on demand)
- a specific accessory allowing to fix the product on the desk
- a reliable and secure installation with conformity to NFC 61-314
- index of protection: IK07
- Finishes available :
 - . natural anodized aluminium
 - . wiring devices and plastic parts colour white RAL 9003

Packaging : 1

1.1 Desktop multi-outlets

1.1.1 Prewired

Supplied without cord

Connection on terminal blocks with cable grip

Numbers	Dimensions Lxlxh (mm)	Functions
0 546 00	280X90x80	
0 546 01	370x90x80	
0 546 15	280x90x80	
0546 16	330x90x80	
0546 20	330x90x80	
0546 21	460x90x80	

1. RANGE (continued)

1.1.2 With cords

Supplied with cord

Connection on terminal blocks with cable grip



Numbers	Dimensions Lxlxh (mm)	Functions
French std 0 546 25	280x90x80	
German std 6 535 60		
French std 0 546 26	370x90x80	
German std 6 535 61		
German std 6 535 63	330x90x80	
French std 0 546 27	280x90x80	
French std 0 546 28	370x90x80	
French std 0 546 29	370x90x80	
French std 0546 35	280x90x80	
German std 6 535 62		
French std 0546 36	330x90x80	
French std 0546 33	330x90x80	
French std 0 546 31	280x90x80	
French std 0 546 37	370x90x80	

Desktop multi-outlets new design

Number(s) : 0 535 98- 0 546
 00/01/15/16/20/21/25/26/27/28/29/31/33/35/36/37/
 90/91/92/99 - 6 535 60 à 63

1. RANGE (continued)

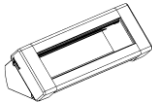
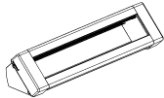
1.1.3 Empty to be equipped

Numbers	Dimensions LxHxh (mm)	Functions
0 546 90	240x90x80	
0 546 91	330x90x80	
0 546 92	420x90x80	

1.2 Accessories

1.2.1 Fixing accessory Number 0 546 99

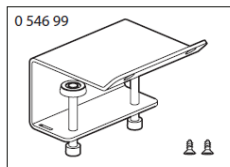

if L > to 400 mm use 2 x 0546 99

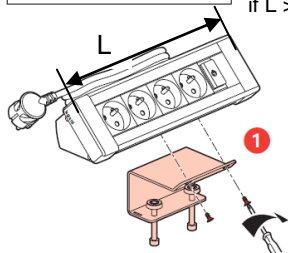

Allow fixing on a desk from 6 to 40 mm of depth

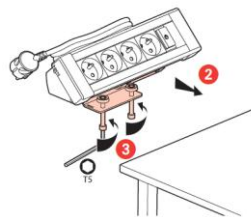

The product includes adhesive protections for desk office surfaces.

Material characteristics of 0 546 99 :

- Steel (painted grey)
- Polyamide
- Elastomer

Packaging : 1

1. RANGE (continued)

1.2 Accessories

1.2.2 Cable worm number 0 535 98



Very suitable solution for a safe and aesthetic protection of the cabling between desk and floor.

Packaging : 1

Length : 0.75m

Cabling capacity :

- minimum dimension of cable : 2x0,5 mm² (5mm diameter) 20 each side
- maximum dimension of cable: 5x2,5 mm² (14mm diameter) 3 each side

Material Characteristics of Nr. 0 535 98

Ring white colour : ABS + *thermoplastic polyurethane* (for the membrane)

- Fixation accessory: ABS
- Base : plastic part = EPDM
- Metal plate = FE

2. ON DEMAND

Selection of desktop multi-outlet new design

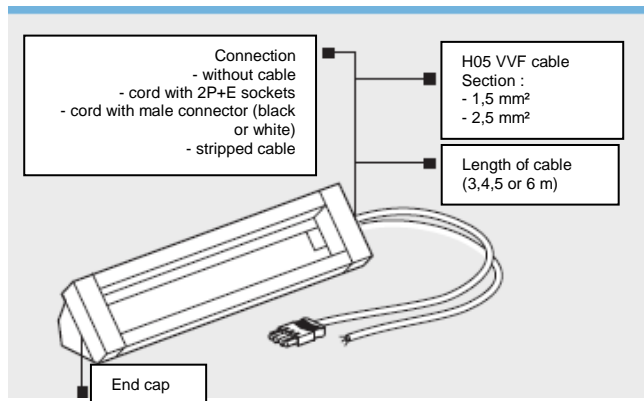

The length of the unit varies depending on the quantity of functions needed.

Selection of functions

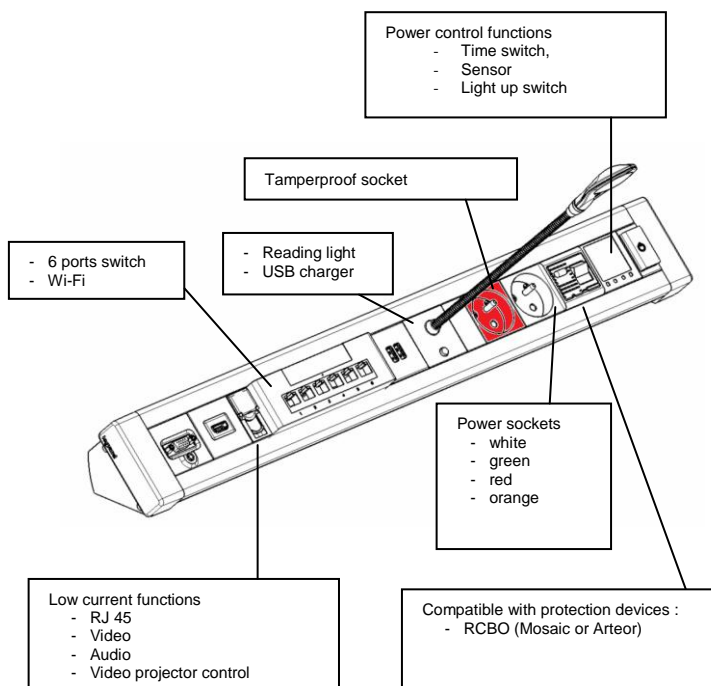

3. TECHNICAL CHARACTERISTICS (continued)

3.1 Connection

Use 3G1,5 mm² or 3G2,5 mm²

3.1.1 With 2 power circuits and RJ45 plugs

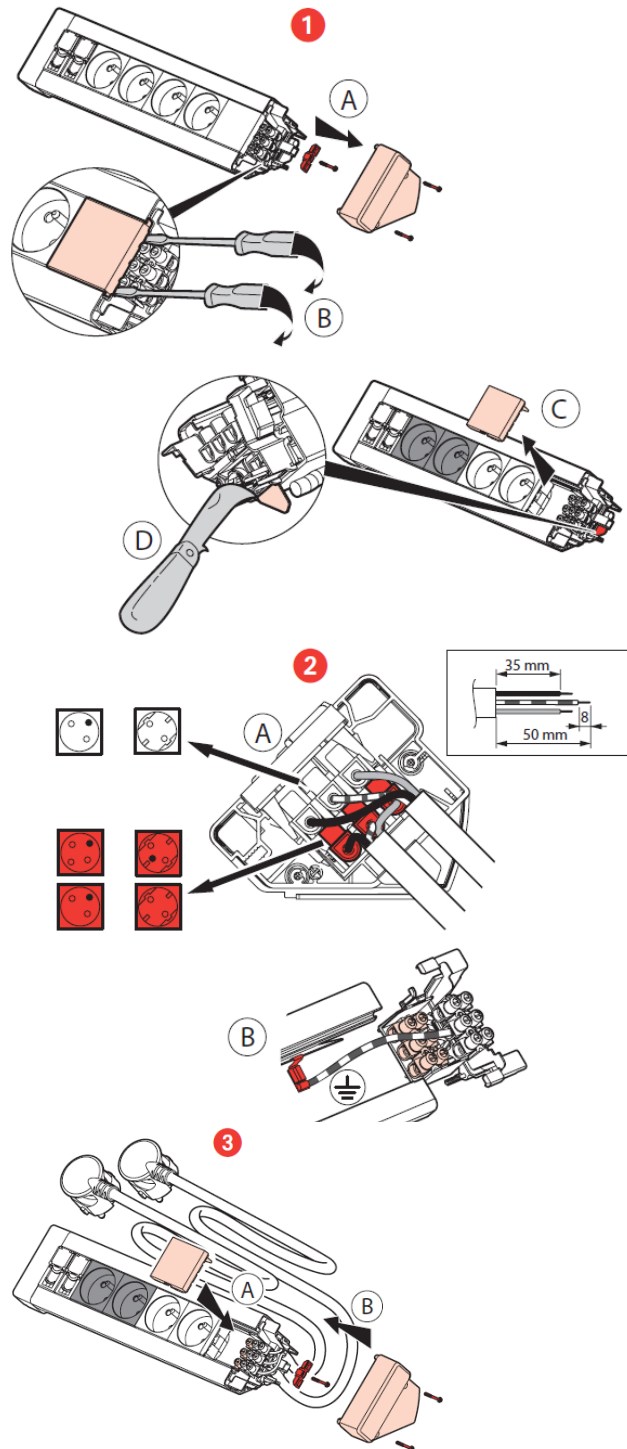
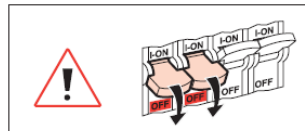

3. TECHNICAL CHARACTERISTICS (continued)

3.1.2 Connection of data sockets through the end cap

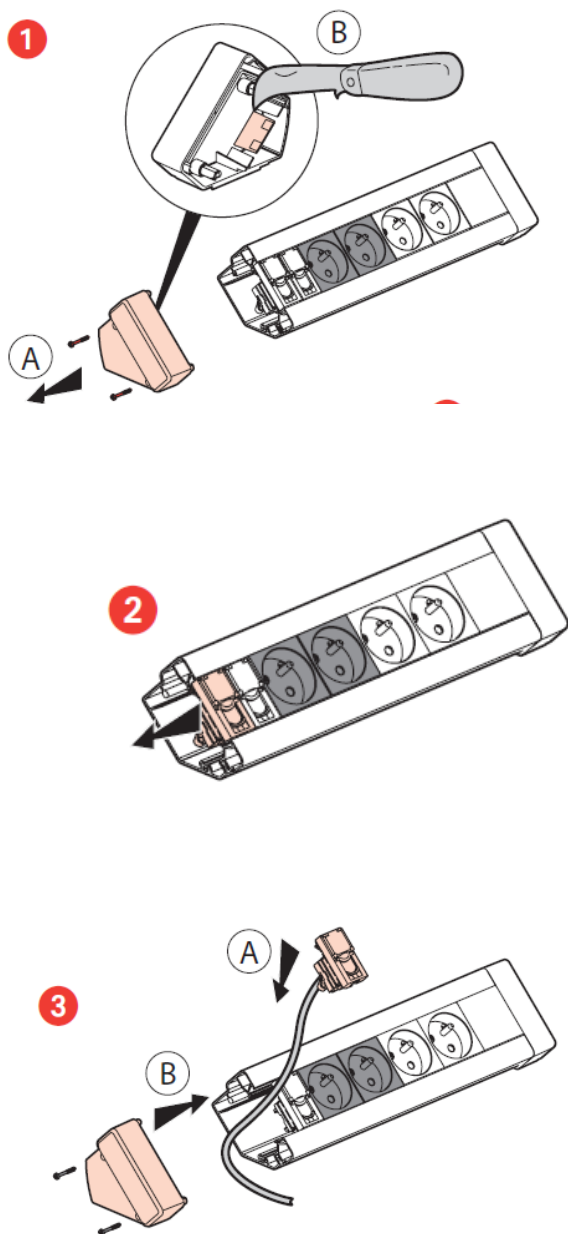

3. TECHNICAL CHARACTERISTICS (continued)

3.1.3 With 1 power circuit

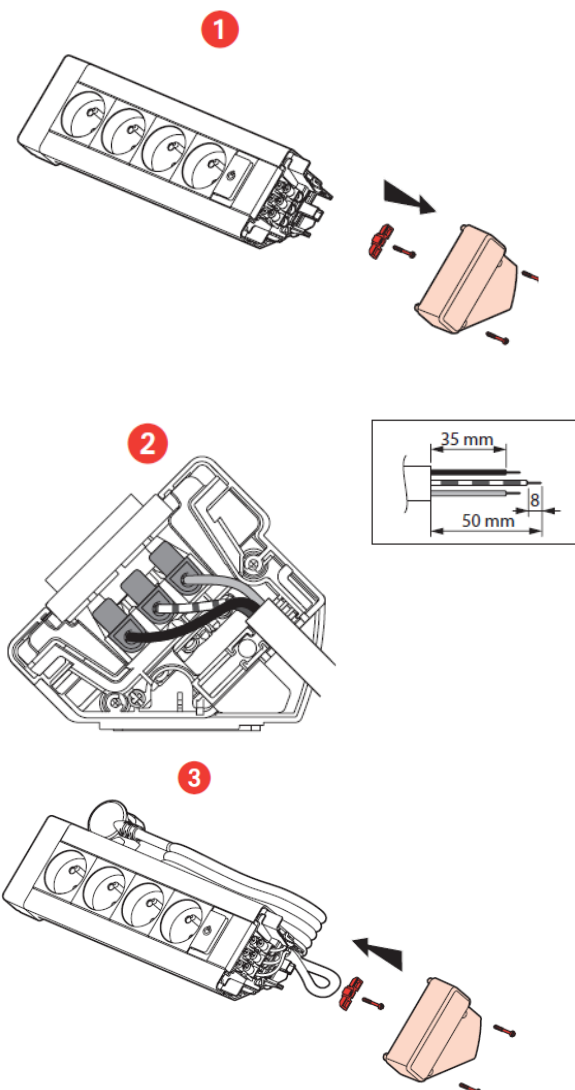
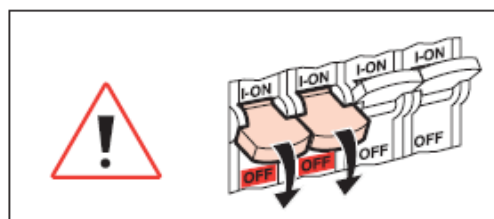

3. TECHNICAL CHARACTERISTICS (continued)

Maximum power : 16A 3680W in 230V

If delivered with cord :

Cable type : 3 meters HO5 VVF 3G 1.5 mm²

Plug type : 2P+T side outlet plug

Other plugs available on demand

Power on the right side (2 cables entries)

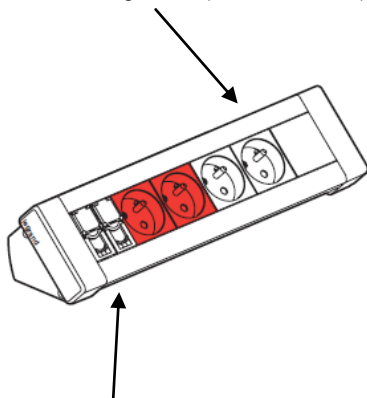

Data on the left side

If not delivered with cord :

Possibility to connect with :

HO5 VVF 3G 1.5 mm² or 3G 2.5 mm² (2 entries max)

4. MATERIAL CHARACTERISTICS

Standard product or on demand, natural anodized aluminium

End caps : white ABS

Cable grip : ABS

Terminal blocks : Polypropylene

Light switch : white PC