

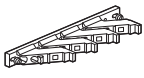

373 90		373 92		H P L	2000 P 800	373 90		373 92		
 In ≤ 800 A		 In ≤ 1600 A				 In ≤ 800 A		 In ≤ 1600 A		
-	●	P : 400	A		C	P : 600	-	● + 473 16	● + 480 26	
	● + 473 15	P : 600				P : 800	-	● + 473 16		
	● + 473 16	P : 800				P : 1000	-			
	● + 473 17	P : 1000								
-	-				D	P : 600	-	+ (2x) 480 26	● + 473 16	+ 480 27
						P : 800	-	+ (2x) 480 27	● + 473 16	
-	-				E	P : 400	●	●		
		P : 500				P : 500	● + 480 33	● + 480 33		
		P : 600				P : 600				
		P : 800				P : 800	● + 480 33	● + 480 33		
		P : 1000				P : 1000				
●	●	P : 400	B		F	P : 800	● + 480 33	● + 480 33		
● + 473 15	● + 473 15	P : 600								
● + 473 16	● + 473 16	P : 800								
● + 473 17	● + 473 17	P : 1000								
●	●	L : 400	B		G	P : 500	● + 480 33	● + 480 33		
● + 473 15	● + 473 15	L : 600				P : 600				
● + 473 16	● + 473 16	L : 800				P : 800				
● + 473 17	● + 473 17	L : 1000								
-	-				H	P : 500	● + 480 27	● + 480 27		
						P : 600				
						P : 800				

A P = 400/600/800/1000

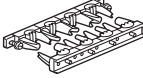
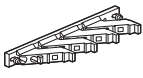
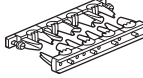

373 92

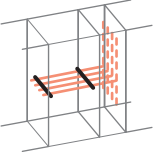
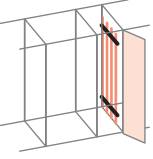
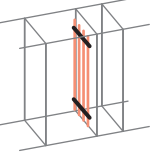
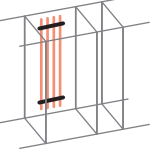
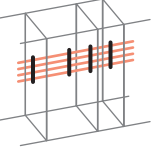
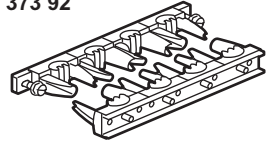

1

P = 400

P = 600/800/1000

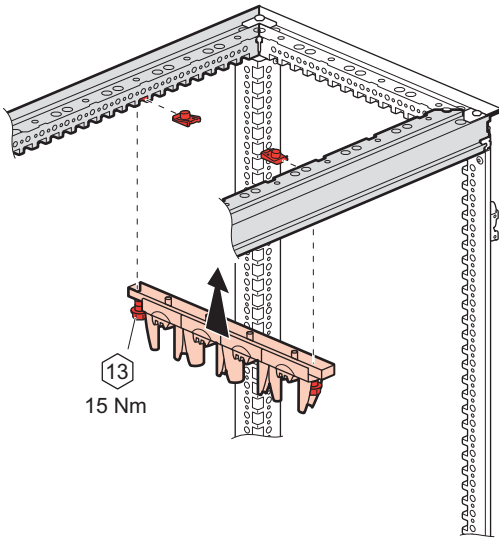

13
15 Nm

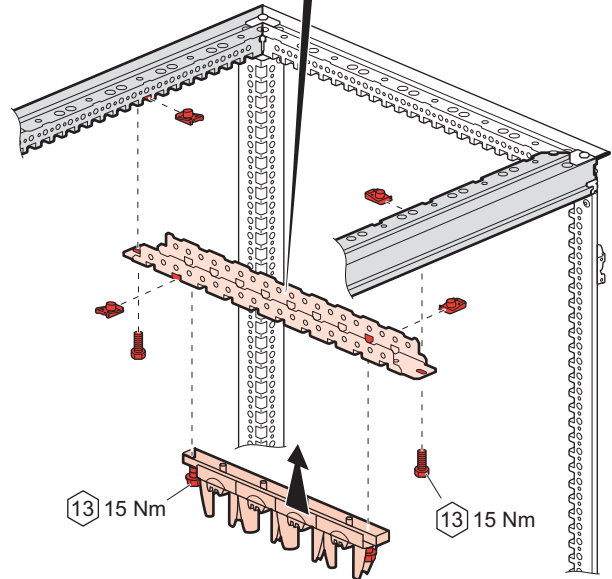
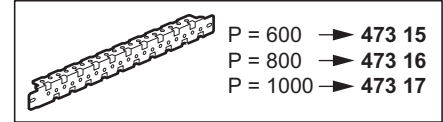

13 15 Nm

13 15 Nm

2

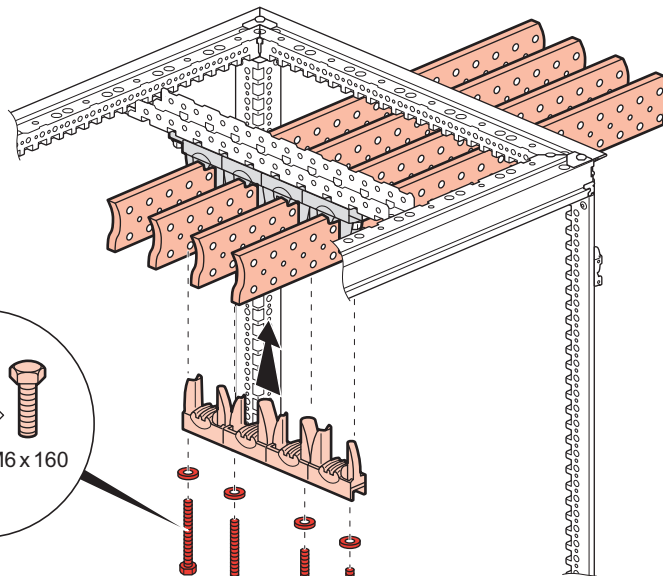

10 7 Nm

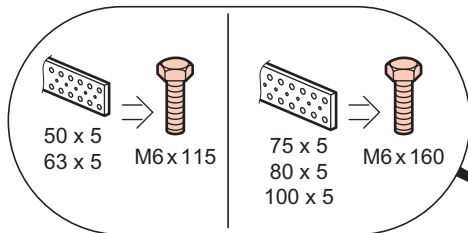

B P = 400/600/800/1000
L = 400/600/800/1000

373 92

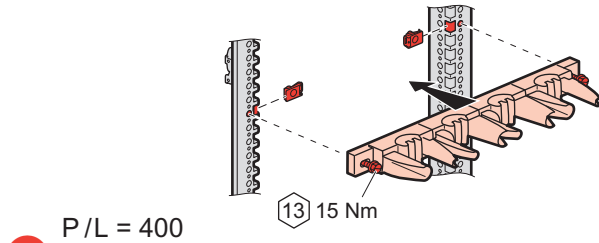
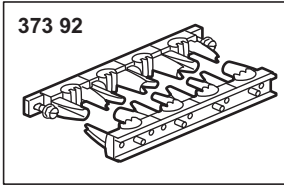
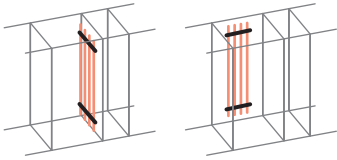

P/L = 400

1 P/L = 600/800/1000

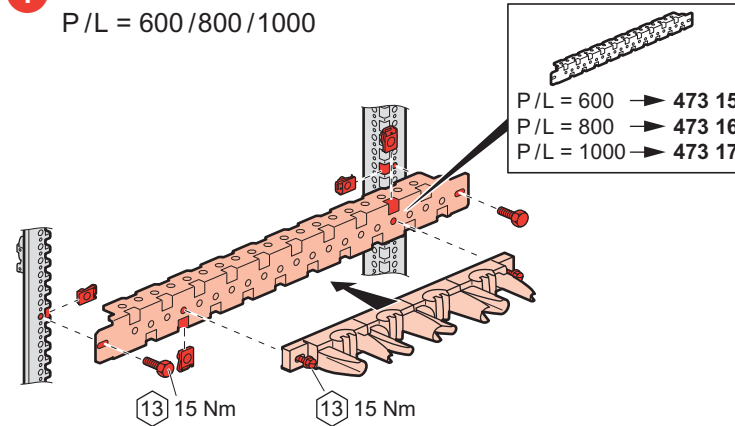

P/L = 600 → 473 15
P/L = 800 → 473 16
P/L = 1000 → 473 17

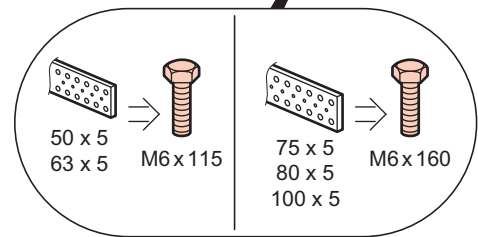
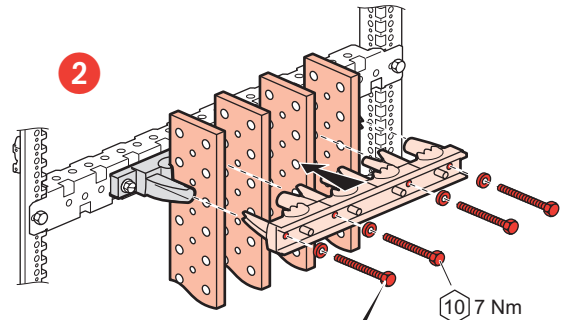

373 90

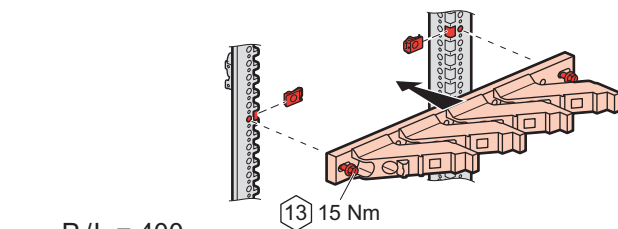
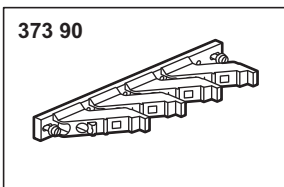

P/L = 400

1 P/L = 600/800/1000

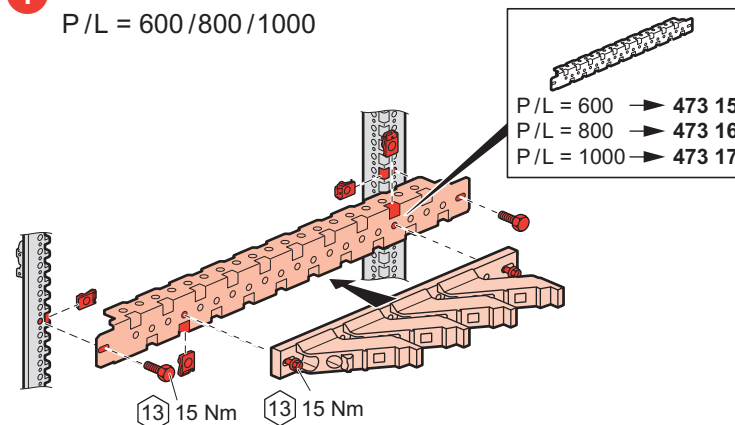

P/L = 600 → 473 15
P/L = 800 → 473 16
P/L = 1000 → 473 17

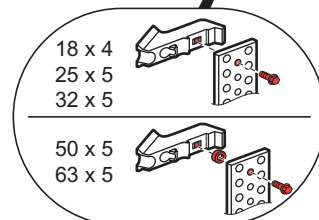
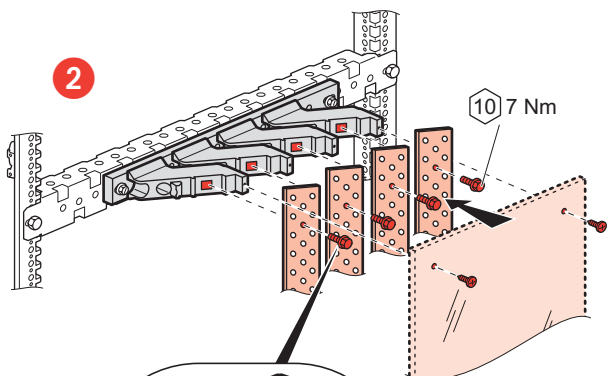

C P = 600/800/1000

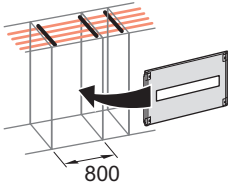

373 92

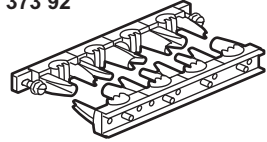

P = 600

473 16

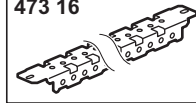

480 26

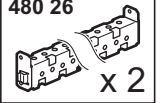

1

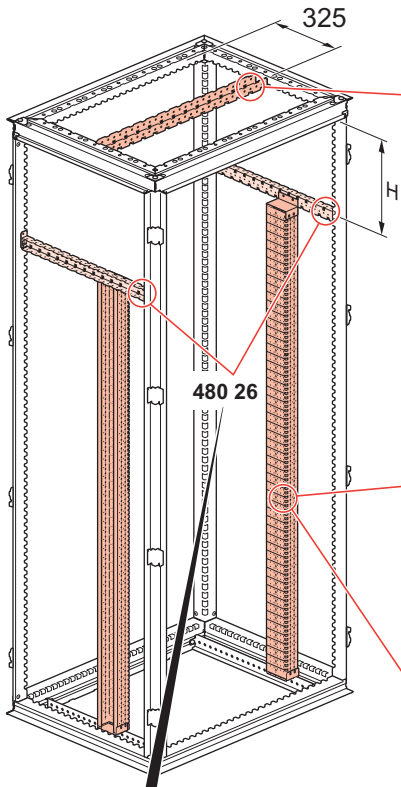

473 16

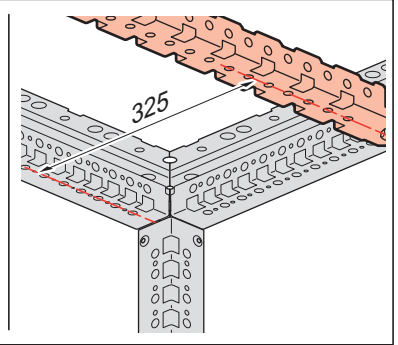
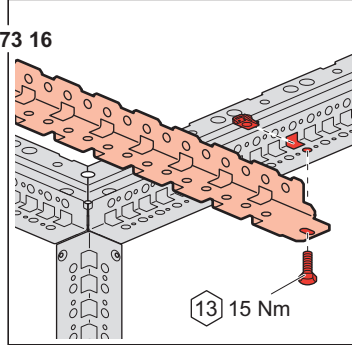

474 80

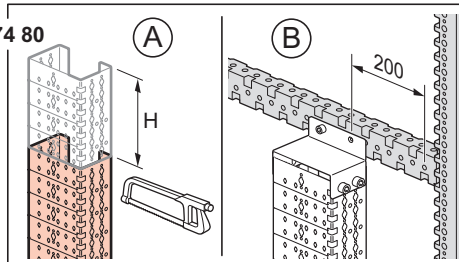

474 81

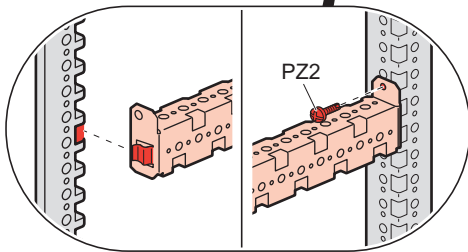
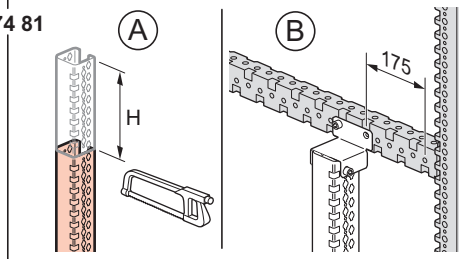

2

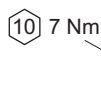
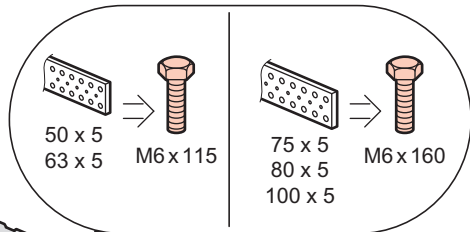
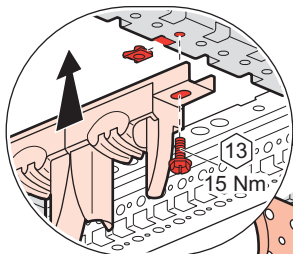

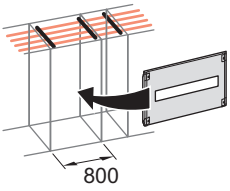

P = 800/1000

373 92

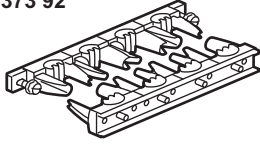

473 16

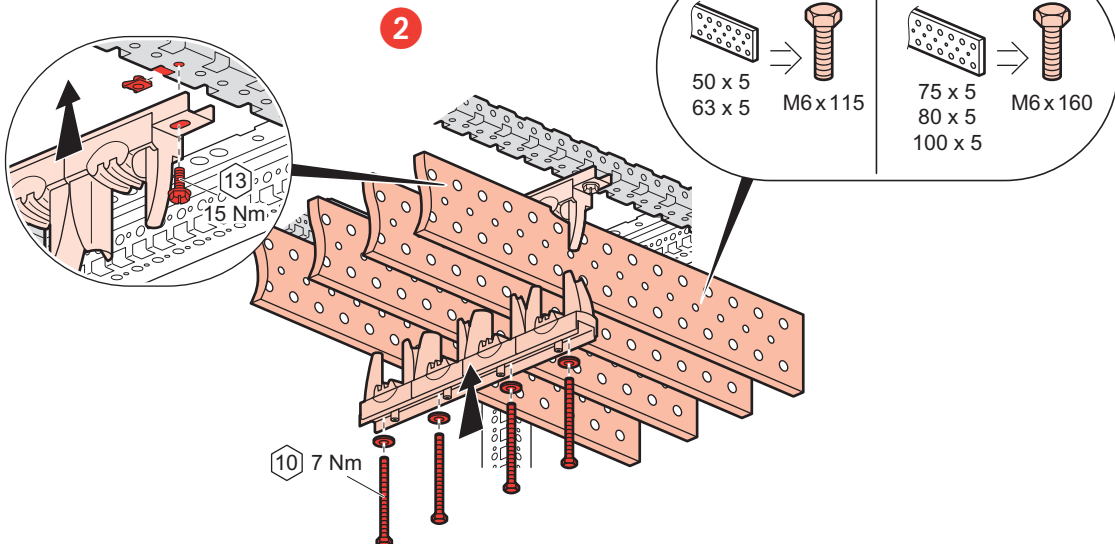
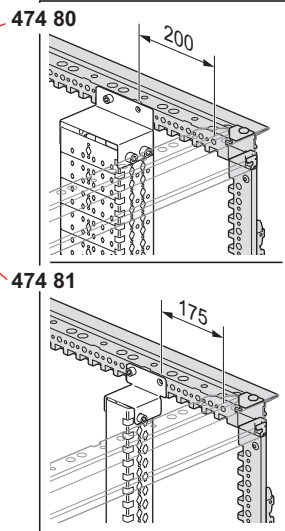
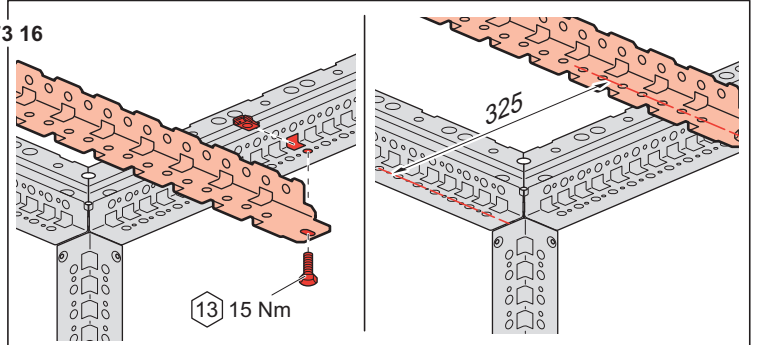
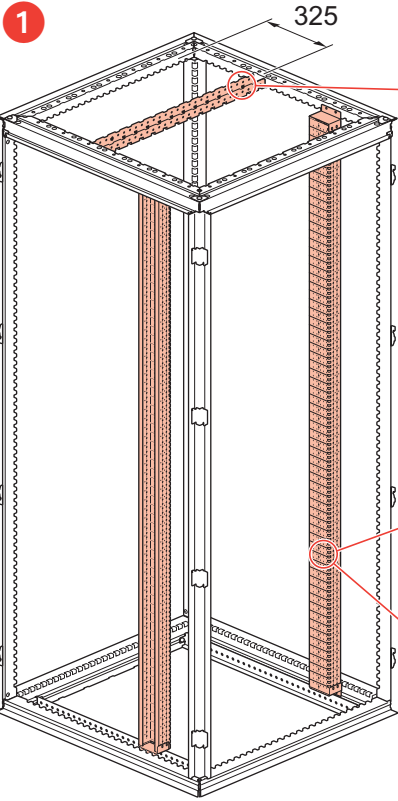
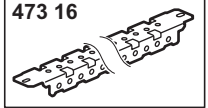

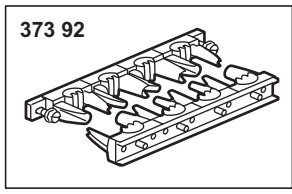
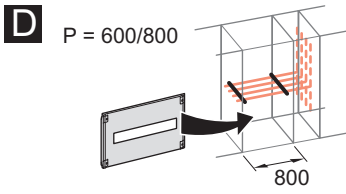

P = 600

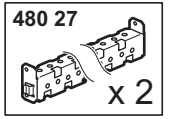
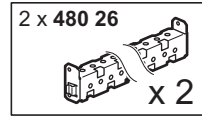
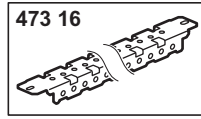

1

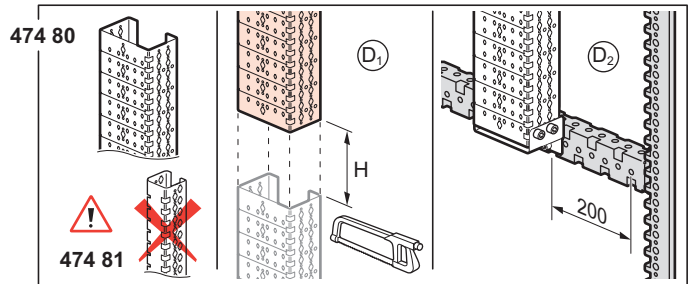
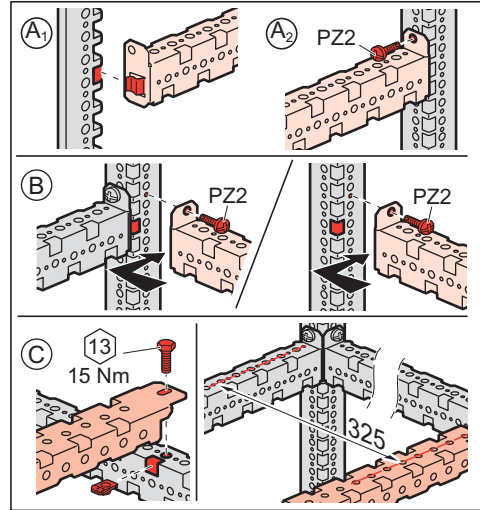
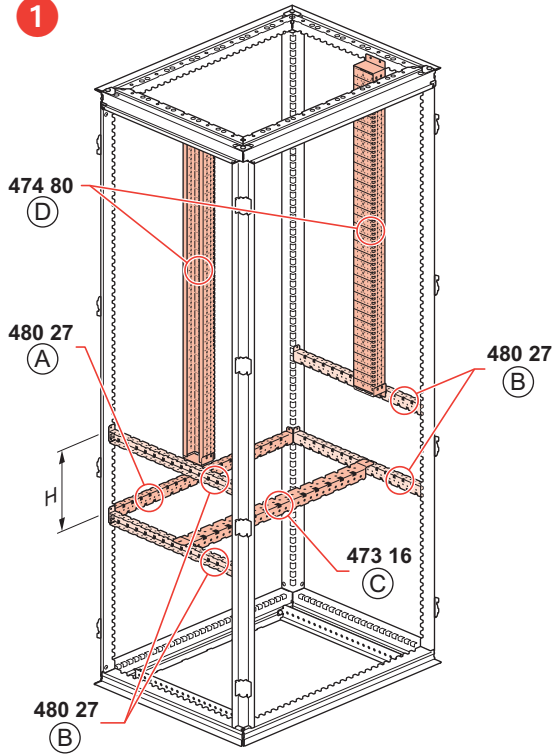

2

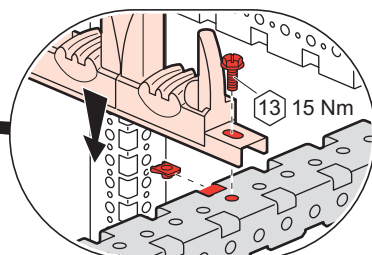
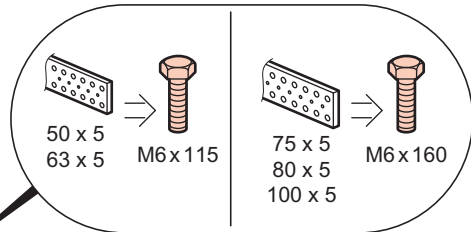
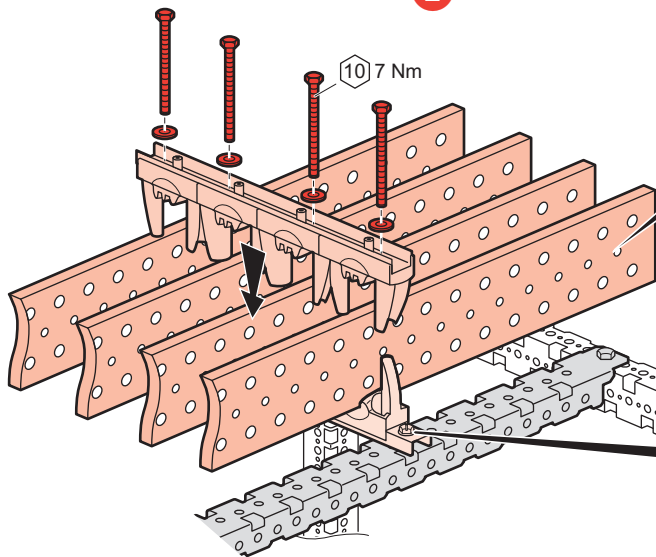

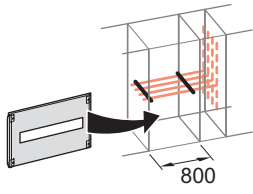

P = 800

373 92

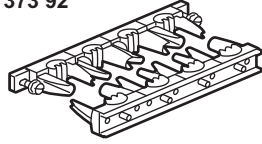

473 16

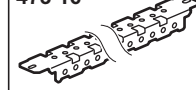

2 x 480 27

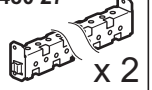

1

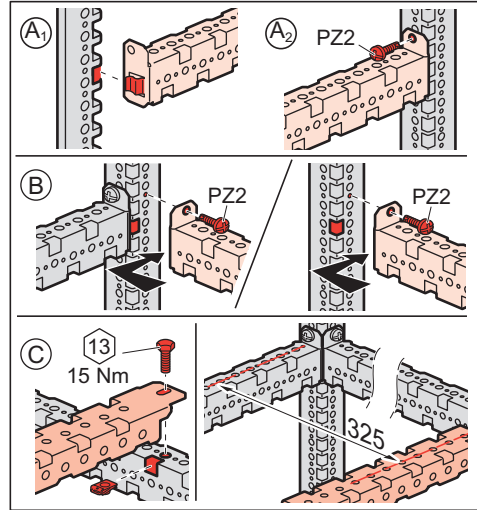
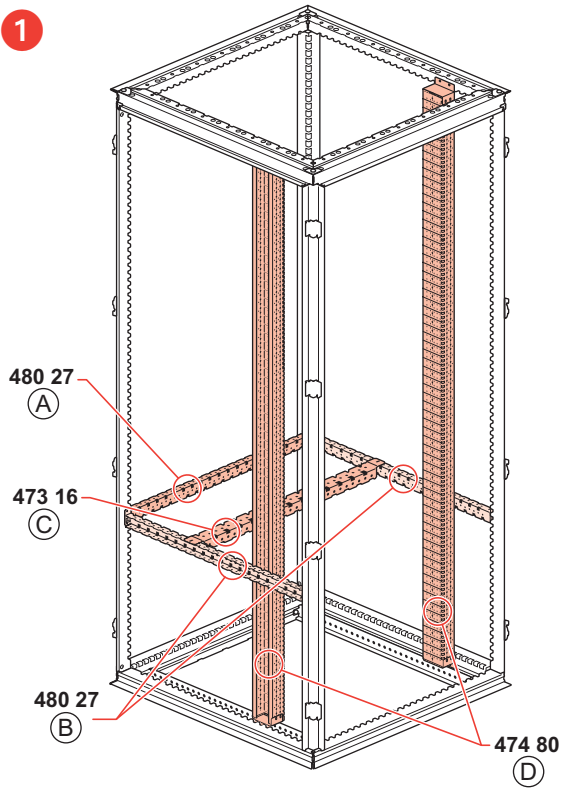

474 80

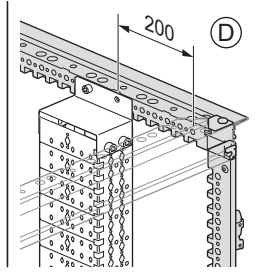
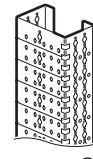

474 81



2

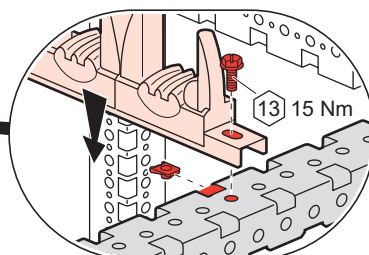
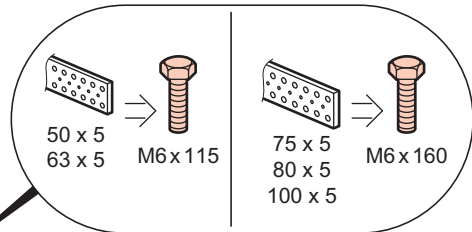
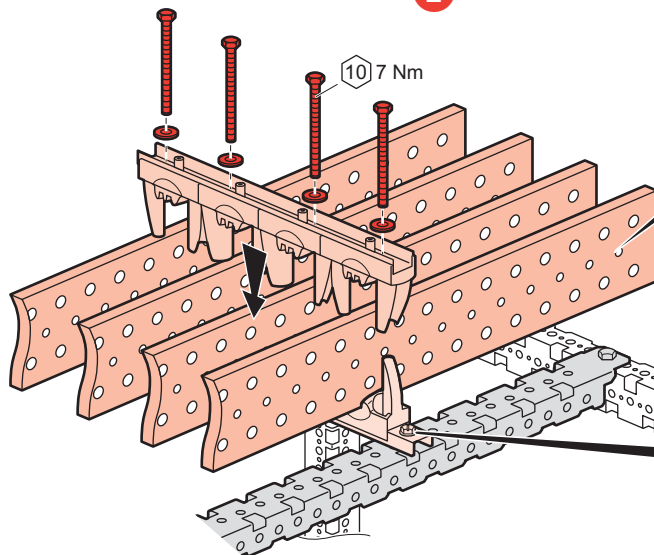

E P = 400/500/600/800/1000

373 90

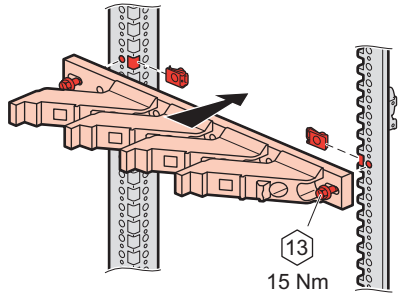
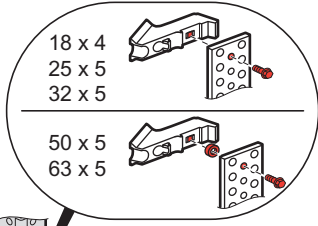
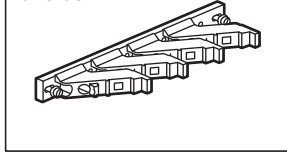
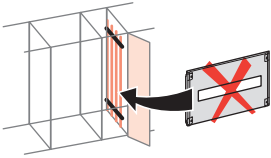

P = 400

1

P = 500/600/800/1000

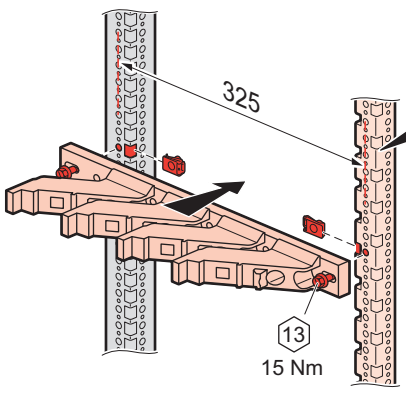
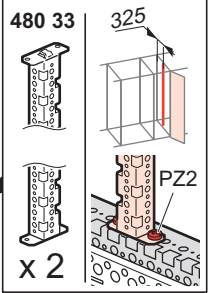

2

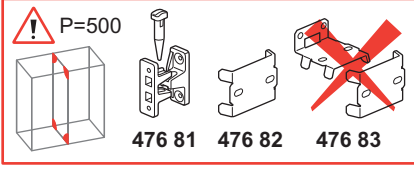
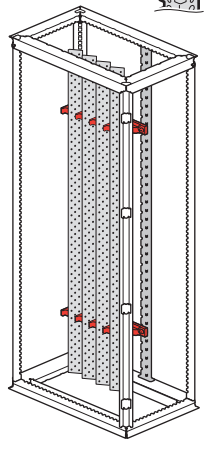
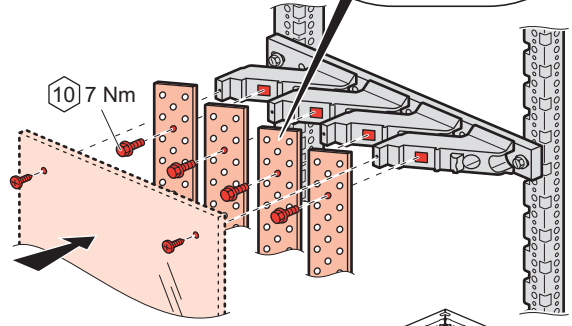

373 92

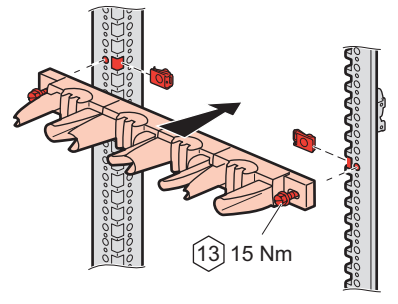
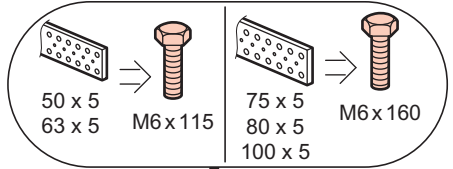
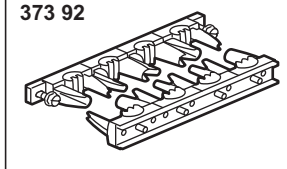

P = 400

1

P = 500/600/800/1000

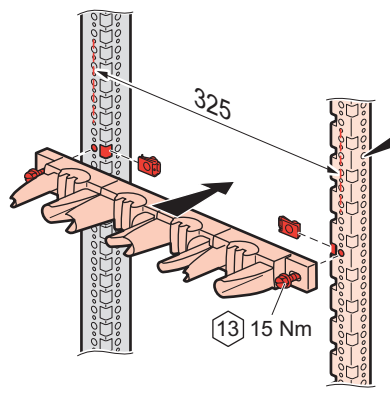
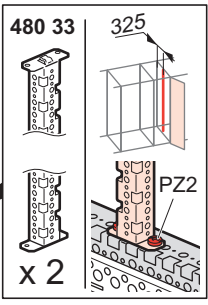

2

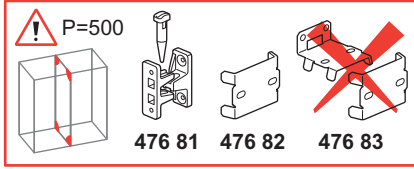
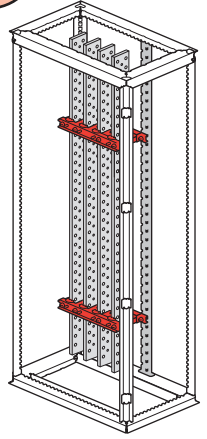
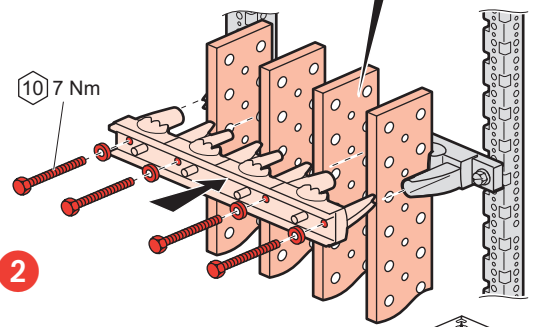

F P = 800

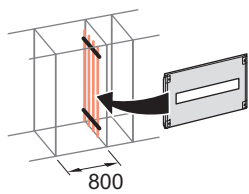

373 90

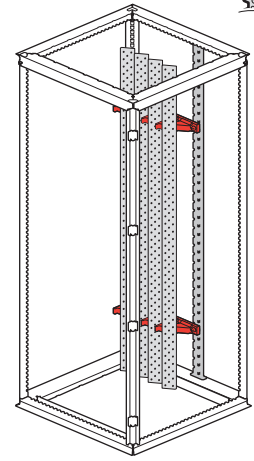
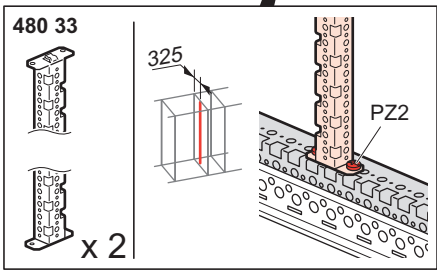
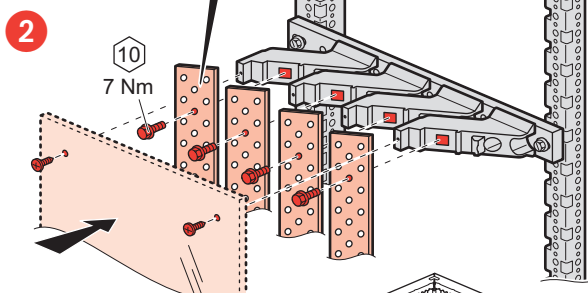
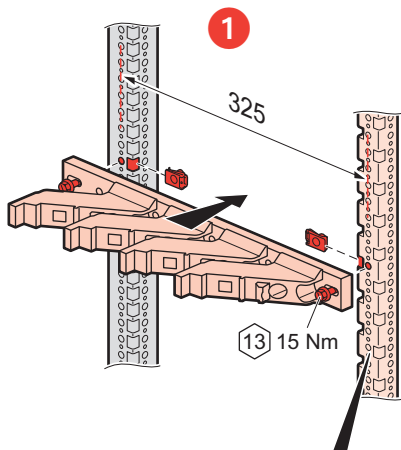
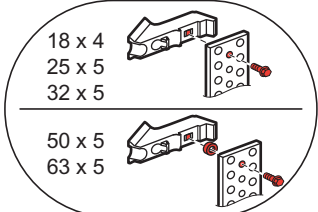
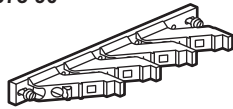

373 92

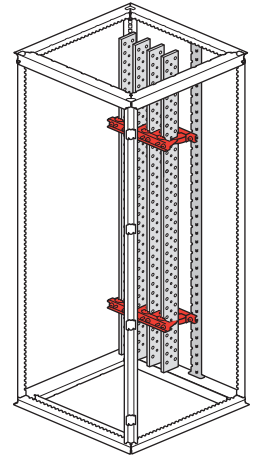
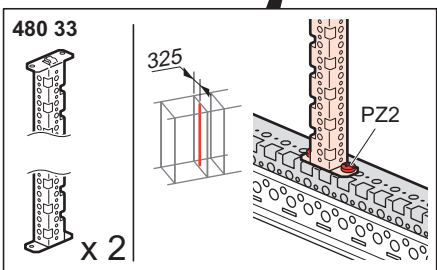
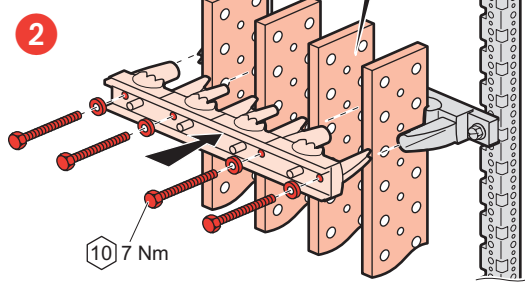
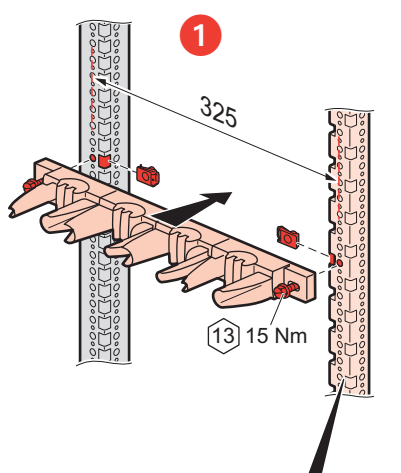
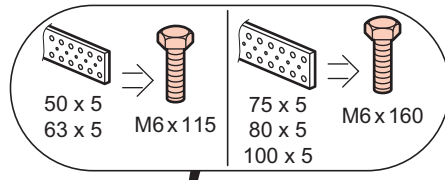
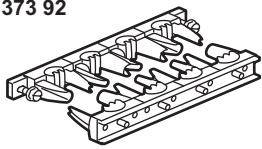

G P = 500/600/800

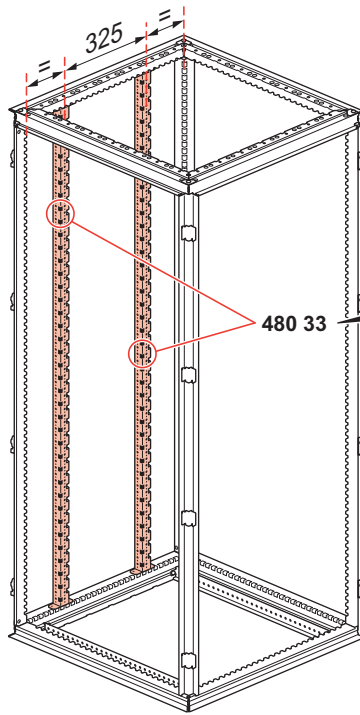
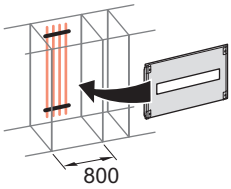

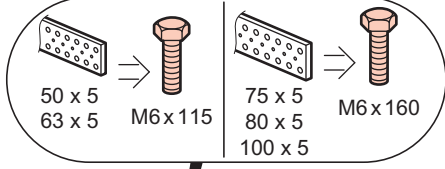
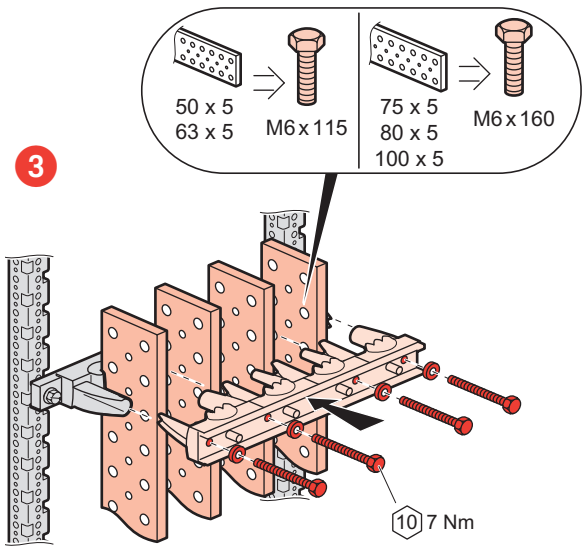
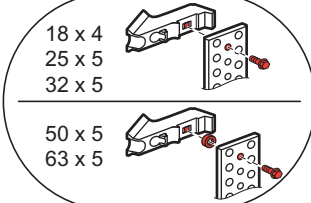
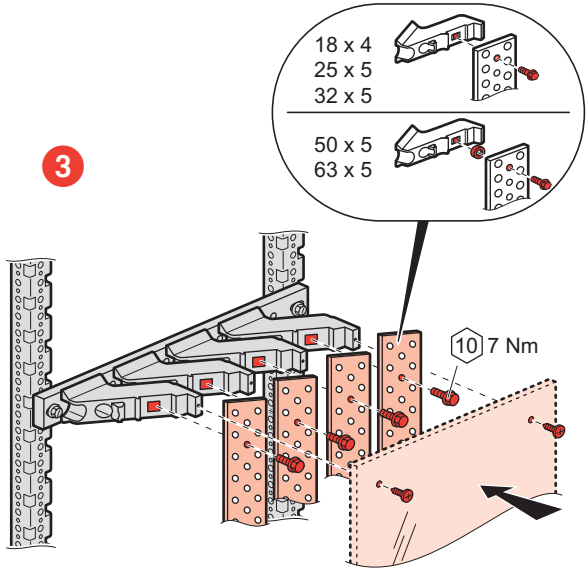
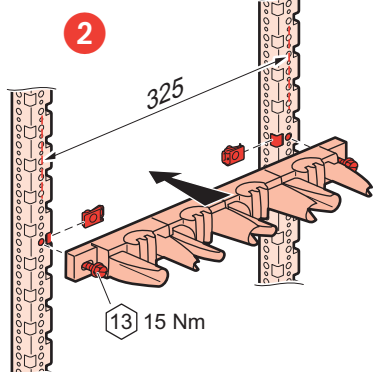
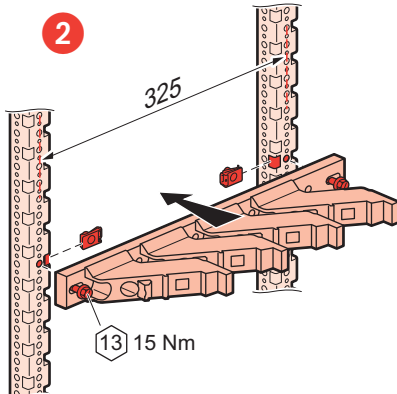
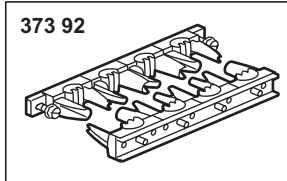
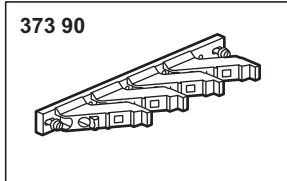
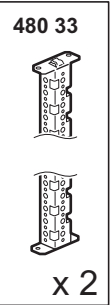
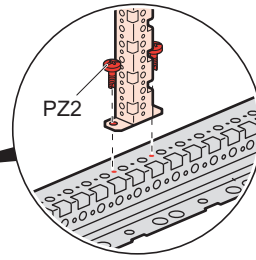

1

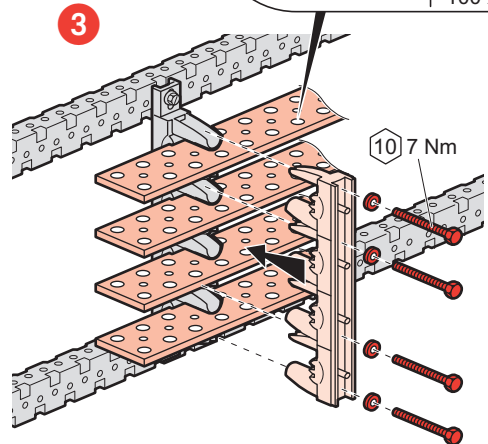
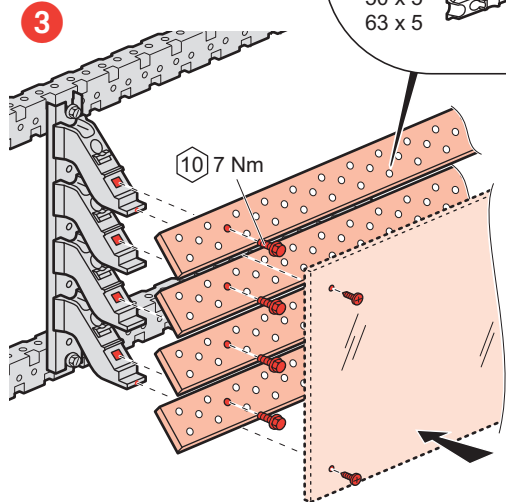
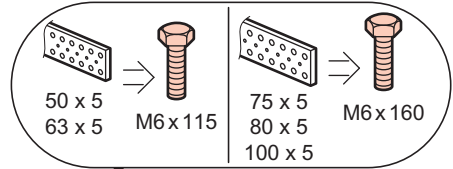
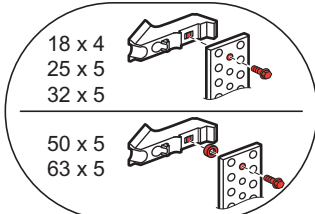
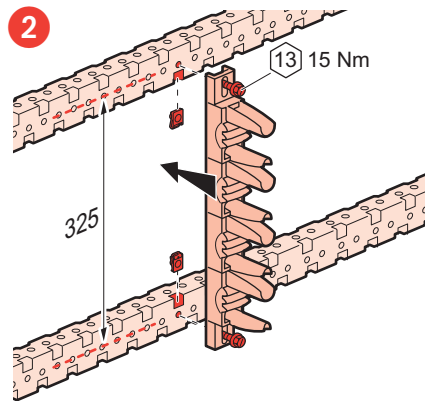
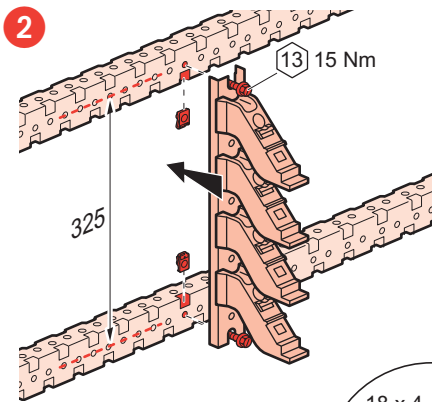
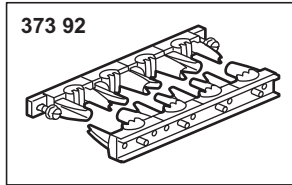
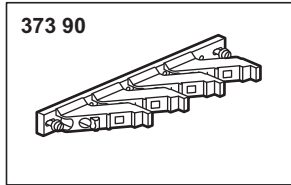
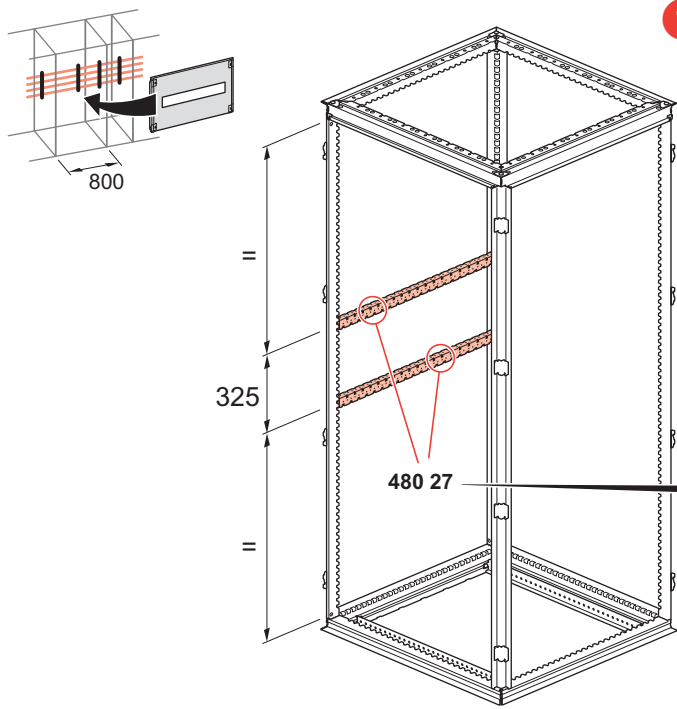



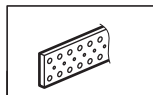

373 90

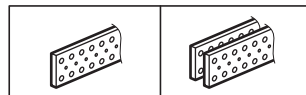

	I (A)	
	IP ≤ 30	IP > 30
18 x 4	245	200
25 x 5	330	270
32 x 5	450	400
50 x 5	700	630
63 x 5	800	700

373 92



	I (A)		I (A)	
	IP ≤ 30	IP > 30	IP ≤ 30	IP > 30
50 x 5	700	630	1150	1000
63 x 5	800	700	1350	1150
75 x 5	950	850	1500	1300
80 x 5	1000	900	1650	1450
100 x 5	1250	1050	1900	1600

373 90

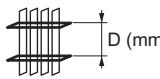

	374 34 18 x 4	374 18 25 x 5	374 19 32 x 5	374 40 50 x 5	374 41 63 x 5
lcc crête (lpk en kA)					
10	800	800	900	-	-
15	400	600	600	700	800
20	300	450	500	600	700
25	250	350	400	500	550
30	225	300	350	400	450
35	200	250	300	350	400
40	175	200	250	275	300
45	150	200	200	225	250
50	150	150	150	200	200
60	125	125	125	150	150
70	100	100	100	150	150
80	-	-	-	100	100
90	-	-	-	-	-

373 92

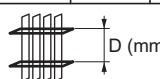

	374 40 50 x 5	374 41 63 x 5	374 59 75 x 5	374 43 80 x 5	374 46 100 x 5
lcc crête (lpk en kA)					
10	1000	1200	1200	1200	1200
15	800	900	1000	1000	1200
20	650	700	750	750	900
25	500	600	600	600	700
30	400	500	550	550	600
35	350	450	450	450	550
40	300	350	400	400	450
45	300	300	350	350	400
50	250	250	300	300	350
60	200	250	250	250	300
70	150	200	250	250	250
80	100	150	200	200	200
90	100	150	200	200	200
100	100	150	150	150	150
110	100	100	150	150	150
120	100	100	100	100	100

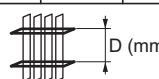

	374 40 50 x 5	374 41 63 x 5	374 59 75 x 5	374 43 80 x 5	374 46 100 x 5
lcc crête (lpk en kA)					
10	-	-	-	-	-
20	-	-	-	-	-
30	700	800	-	-	-
40	550	600	650	650	700
50	450	500	500	500	550
60	350	400	400	400	450
70	250	350	350	350	400
80	250	300	300	300	300
90	200	250	300	300	300
100	200	200	250	250	250
110	200	150	200	200	200
120	150	150	200	200	200