

Viking 3 - Screw connection Connecting terminal blocks

Cat. Nos: 0 371 00/01/02/03/04/05/07/08/09/20/21/30/31
0 371 51/60/61/62/63/64/65/66/67/68/69/77/78
0 371 98/99

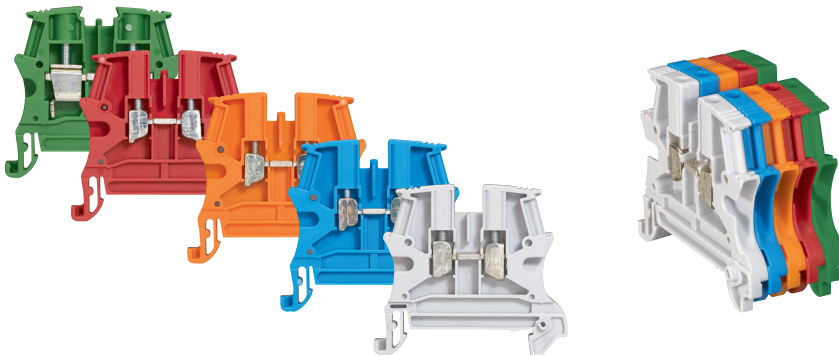

CONTENTS

- 1. General characteristics 1
- 2. Range 2
- 3. Standards 2
- 4. Technical characteristics 2
- 5. Dimensions 4
- 6. Accessories 5

1. GENERAL CHARACTERISTICS

Viking 3 terminal blocks provide the electrical connection between two flexible or rigid copper conductors.

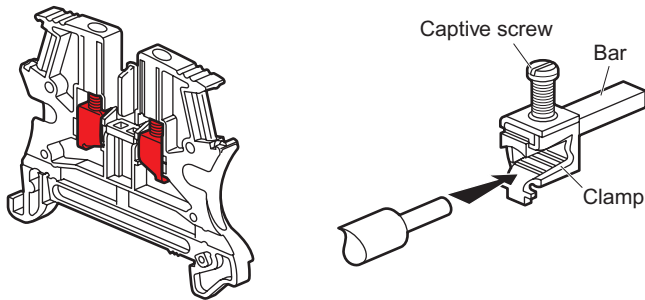

- Insulating polyamide body,
- Tin-coated brass bar ensuring optimum contact quality,
- Zinc plated steel screws and clamps providing excellent mechanical strength.

Block Cat. no. 0 371 60 (70mm²) has pressure screw terminals. These terminals are made of a single piece of brass and tin-plated screws.

A locking pin on the insulating body ⁽¹⁾ holds the Viking 3 blocks together, making them easier to handle and contributing to perfect alignment on the rail. Blocks can still be fitted or taken apart without having to remove adjacent blocks.

Conductors are easy to insert due to the ergonomic shape of their entry system.

Starfix cabling ferrules provide an equipotential link for all the strands of a flexible conductor.

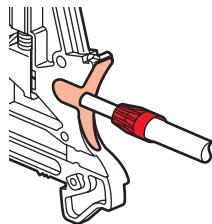

The base enables blocks to be fitted on 3 types of rail.

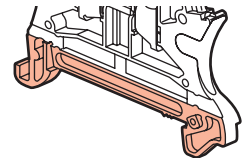

	EN 60715		
	-	1	2.2
Thickness (mm)	1.5	1	2.2
Depth (mm)	15	7.5	15

Blocks have two marking areas on each level.

Up to a pitch of 8 mm, blocks have two areas for screwless, equipotential bridging combs with automatic insertion (see 6.3).

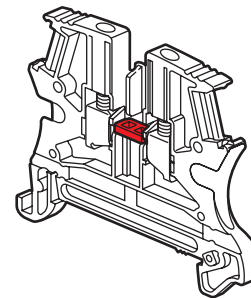

Terminal block colours depend on circuit type:

- Grey for standard circuits,
- Blue for neutral conductors,
- Orange for circuits not broken by the master isolating device,
- Red for specific circuits (safety, protected, etc.),
- Green for protection circuits sets equivalent to Class II.

ATEX

Refer to the specific technical data sheet regarding use in explosive atmospheres.

PHOTOVOLTAIC APPLICATION

See specific Viking 3 range (cat. nos: 4 148 00 / 01 / 02 / 03 / 04)

⁽¹⁾ Except 70mm² block Cat. no. 0 371 66

Viking 3 - Screw connection Connecting terminal blocks

Cat. Nos: 0 371 00/01/02/03/04/05/07/08/09/20/21/30/31
0 371 51/60/61/62/63/64/65/66/67/68/69/77/78
0 371 98/99

2. RANGE

Cross-section according to IEC EN 60947-7-1.

2.1 Blocks with 1 connection - 1 entry/1 outlet

Cat. Nos	Colour	Nominal cross-section (mm ²)	Pitch (mm)
0 371 60	grey	2.5	5
0 371 00	blue		
0 371 20	orange		
0 371 30	red		
0 371 61	grey	4	6
0 371 01	blue		
0 371 21	orange		
0 371 31	red		
0 371 77	green		
0 371 62	grey	6	8
0 371 02	blue		
0 371 78	green		
0 371 63	grey	10	10
0 371 03	blue		
0 371 64	grey	16	12
0 371 04	blue		
0 371 98	green		
0 371 65	grey		
0 371 05	blue	35	15
0 371 99	green		
0 371 66 ⁽¹⁾	grey	70	22

⁽¹⁾ With integrated end cap.



cat. no. 0 371 66

2.2 Blocks with 1 connection - 2 entries/2 outlets

Cat. Nos	Colour	Nominal cross-section (mm ²)	Pitch (mm)
0 371 69	grey	4	6
0 371 09	blue		

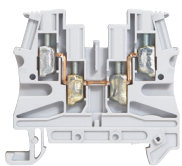

cat. no. 0 371 69

2.3 Blocks with 2 connections - 2 levels

Cat. Nos	Colour	Nominal cross-section (mm ²)	Pitch (mm)
0 371 67	grey	2.5	5
0 371 07	blue		
0 371 68	grey	4	6
0 371 08	blue		

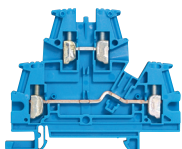

cat. no. 0 371 08

2.4 Blocks with 3 connections - 3 levels

Cat. Nos	Colour	Nominal cross-section (mm ²)	Pitch (mm)
0 371 51	grey	2.5	5

Block Cat. No. 0 371 51 is also used to connect sensors (see diagram in 4.11).

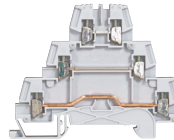

cat. no. 0 371 51

3. STANDARDS

- **IEC EN 60947-1:**
Low-voltage switchgear and controlgear,
- **IEC EN 60947-7-1:**
Low-voltage switchgear and controlgear - Part 7-1: ancillary equipment
- Terminal blocks for copper conductors,
- **CSA C22-2 N°158:**
Terminal blocks,
- **UL 1059:**
Terminal blocks,
- **IEC 60364-5-52:**
Electrical installations of buildings - Part 5-52: Selection and erection of electrical equipment - Wiring systems.
- **IEC EN 60664-1:**
Insulation coordination for equipment within low-voltage systems (networks) - Part 1: principles, requirements and tests.
- **UL 94:**
Tests for flammability of plastic materials for parts in devices and appliances,
- **IEC EN 60529:**
Degrees of protection provided by enclosures (IP code).

4. TECHNICAL CHARACTERISTICS

4.1 Type of conductor

Connection conductors shall be in copper - flexible or rigid:

- Class 1, rigid core,
- Class 2, cabled rigid core,
- Class 5, flexible core,
- Flexible core with ferrule.

Viking 3 - Screw connection











Connecting terminal blocks

Cat. Nos: 0 371 00/01/02/03/04/05/07/08/09/20/21/30/31
0 371 51/60/61/62/63/64/65/66/67/68/69/77/78
0 371 98/99

4. TECHNICAL CHARACTERISTICS (continued)

4.2 Connection cross-section











According to IEC EN 60947-7-1

Cat. Nos	Nominal cross-section (mm ²)	Pitch (mm)	Capacity (mm ²)	
			Rigid conductor	Flexible conductor with or without ferrules
 0 371 00/20/30/60	2.5	5	0.25 to 4	0.25 to 2.5
 0 371 01/21/31/61/77	4	6	0.25 to 6	0.25 to 4
 0 371 02/62/78	6	8	0.5 to 10	0.25 to 6
 0 371 03/63	10	10	1.5 to 16	2.5 to 10
 0 371 04/64/98	16	12	1.5 to 25	4 to 16
 0 371 05/65/99	35	15	2.5 to 50	4 to 35
 0 371 66	70	22	25 to 95	16 to 70
 0 371 09/69	4	6	0.25 to 6	0.25 to 4
 0 371 07/67	2,5	5	0.25 to 4	0.25 to 2.5
 0 371 08/68	4	6	0.25 to 6	0.25 to 4
 0 371 51 ⁽¹⁾	2,5	5	0.25 to 4	0.25 to 2.5

(1) Capacity - rigid conductor: 2.5 mm² max. with bridging comb.

Viking 3 terminal blocks take account of the dimensions of the ferrule for flexible conductors (Starfix double ferrules, see 4.8).











According to CSA No. 22-2 No. 158 and UL 1059

Cat. Nos	Nominal cross-section (AWG)	Pitch (mm)
 0 371 00/20/30/60	12	5
 0 371 01/21/31/61/77	10	6
 0 371 02/62/78	8	8
 0 371 03/63	6	10
 0 371 04/64/98	4	12
 0 371 05/65/99	2	15
 0 371 66	000	22
 0 371 09/69	10	6
 0 371 07/67	12	5
 0 371 08/68	10	6
 0 371 51	12	5

4.3 Conductor stripping length

Cat. Nos	Pitch (mm)	Length (mm)
0 371 00/07/20/30/51/60/67	5	6 to 8
0 371 01/08/09/21/31/61/68/69/77	6	
0 371 02/62/78	8	10 to 12
0 371 03/63	10	
0 371 04/64/98	12	13 to 17
0 371 05/65/99	15	
0 371 66	22	15 to 22











4.4 Tightening torque

Cat. Nos	Torque (Nm)	Screwdriver blade Ø (mm) ⁽¹⁾	Other tool	
 0 371 00/20/30/60	0.8	3.5	-	
 0 371 01/21/31/61/77	1.4	4		
 0 371 02/62/78	1.4	4		
 0 371 03/63	2	5.5		
 0 371 04/64/98	2	5.5		PZ2
 0 371 05/65/99	4	6.5		PZ2
 0 371 66	10	-	Allen wrench 5 mm	
 0 371 09/69	1.4	4	-	
 0 371 07/67	0.8	3.5	-	
 0 371 08/68	1.4	4		
 0 371 51	0.8	3.5	-	

(1) : For slotted head screw

4.5 Insulating voltage and current

The AC and DC performance of Viking 3 blocks is identical.

Cat. Nos	Voltage (V)			Current (A)			
	IEC	CSA	UL	I _e	IEC ⁽¹⁾	CSA	UL
 0 371 00/20/30/60	800	600	600	27	24	20	20
 0 371 01/21/31/61/77	800	600	600	36	32	30	30
 0 371 02/62/78	800	600	600	48	41	46	46
 0 371 03/63	800	600	600	63	57	60	60
 0 371 04/64/98	800	600	600	85	76	85	85
 0 371 05/65/99	800	600	600	138	125	115	115
 0 371 66	1000	600	600	213	192	200	200
 0 371 09/69	500	300	300	36	32	30	30
 0 371 07/67	500	300	300	27	24	20	20
 0 371 08/68	500	300	300	36	32	30	30
 0 371 51	400	300	300	27	24	20	20

IEC EN 60947-7-1, CSA N°22-2 N°158, UL 1059

I_e: operating current:

- insulated conductors PR/EPR (θ max. 90°C), NF C 15-100 table 52H,
- insulated conductors PVC (70°C), fitting system C, IEC 60364-5-52 table 52.2,
- insulated conductors PR/EPR (θ max. 90°C), fitting system B2, IEC 60364-5-52, table 52.5.

(1) : IEC values also correspond to operating currents I_e for:

- insulated conductors PVC (θ max. 70°C), NF C 15-100 table 52H column 2,
- insulated conductors PVC (70°C), fitting system B1, IEC 60364-5-52 table A52.2

Insulating voltage of shunted blocks: see 6.3, 6.4 and 6.5

4.6 Use category and protection class

Use category according to IEC EN 60947-1:

- Material group II
- Comparative tracking index (CTI): 400 to 600 V
- Overvoltage category III
- Pollution degree 3

Protection class according to IEC EN 60529:

- Blocks with pitch 5/6 mm: IPXXB
- Blocks with pitch 8/10/12/15/22 mm: IPXXB - front mounting only

Note: the last block in a terminal strip must be fitted with an end cap.

Viking 3 - Screw connection

Connecting terminal blocks

Cat. Nos: 0 371 00/01/02/03/04/05/07/08/09/20/21/30/31
0 371 51/60/61/62/63/64/65/66/67/68/69/77/78
0 371 98/99

4. TECHNICAL CHARACTERISTICS (continued)

4.7 Tapping

Two conductors can be connected at a single connection point under the following conditions:

- Do not mix flexible and rigid cores,
- Do not mix 2 rigid core conductors with different cross-sections.

The combinations of 2 conductors at a single connection point are allowed as illustrated in the table below (mm²):

	Class 1 Solid rigid core	Class 2 Cabled rigid core	Class 5 Flexible core	Flexible core with simple ferrule	Class 5 Flexible core (different cross-sections)
Pitch 5 2,5 mm ²	2 x 0.5 2 x 0.75 2 x 1	2 x 0.5 2 x 0.75 2 x 1	2 x 0.5	2 x 0.5	0.5 + 0.75
					0.5 + 1
					0.75 + 1
					0.75 + 1.5
Pitch 6 4 mm ²	2 x 0.5 2 x 0.75 2 x 1 2 x 1.5	2 x 0.5 2 x 0.75 2 x 1 2 x 1.5	2 x 0.5	2 x 0.5	0.5 + 0.75
					0.5 + 1
					0.75 + 1
					0.75 + 1.5
					1 + 1.5
Pitch 8 6 mm ²	2 x 0.5 2 x 0.75 2 x 1 2 x 1.5 2 x 2.5	2 x 0.5 2 x 0.75 2 x 1 2 x 1.5 2 x 2.5	2 x 0.5	2 x 0.75 2 x 1	0.5 + 0.75
					0.5 + 1
					0.75 + 1
					0.75 + 1.5
					1 + 1.5
					1 + 2.5
Pitch 10 10 mm ²	2 x 1 2 x 1.5 2 x 2.5 2 x 4	2 x 1 2 x 1.5 2 x 2.5 2 x 4	2 x 1	2 x 1.5	1 + 1.5
					1 + 2.5
					1.5 + 2.5
					1.5 + 4
					2.5 + 4
					1.5 + 2.5
Pitch 12 16 mm ²	2 x 1.5 2 x 2.5 2 x 4	2 x 1.5 2 x 2.5 2 x 4	2 x 1.5	2 x 2.5 2 x 4	1.5 + 2.5
					1.5 + 4
					2.5 + 4
					2.5 + 6
					4 + 6
Pitch 15 35 mm ²	2 x 1.5 2 x 2.5 2 x 4 2 x 6	2 x 1.5 2 x 2.5 2 x 4 2 x 6	2 x 2.5	2 x 4 2 x 6	2.5 + 4
					2.5 + 6
					4 + 6
					4 + 10
					6 + 10
					6 + 16
Pitch 22 70 mm ²	2 x 16 2 x 25 2 x 35	2 x 16 2 x 25 2 x 35	-	-	16 + 25
					16 + 35
					25 + 35

4.8 Compatibility with Starfix double ferrules

	Double ferrule (mm2)			
	Cat. No 0 376 87 2x0.75	Cat. No 0 376 88 2x1	Cat. No 0 376 89 2x1.5	Cat. No 0 376 90 2x2.5
Pitch of 5 2,5 mm ²	✓	✓	✗	✗
Pitch of 6 4 mm ²	✓	✓	✓	✗
Pitch of 8 6 mm ²	✓	✓	✓	✓
Pitch of 10 10 mm ²	✓	✓	✓	✓

4.9 Operating conditions

Transport temperature	- 25°C / + 55°C (+ 70°C during 24 hours)
Ambient temperature	- 5°C / + 40°C
	35°C max. over 24 hours
Relative humidity	90% max. at 20°C
	50% max. at 40°C
Altitude	2,000 m max.
Pollution level	3 according to IEC EN 60664-1 and IEC EN 60947-1

Polyamide -30°C to +100°C.

4.10 Fire resistance

- Polyamide V2 according to UL94, halogen free,
- Glow wire: 960°C according to IEC EN 60695-2-11,
- Corrosiveness of fumes: 5% according to NF C 20453,
- Limiting oxygen index (LOI): 27 according to EN ISO 4589-2.

PUBLIC BUILDINGS

The 960°C glow wire resistance according to standard IEC EN 60695-2-11 enables Viking 3 terminal blocks to be used in public buildings, including in safety circuits.

4.11 Use of a terminal block for sensors

Block Cat. No. 0 371 51 is used for connecting sensors and routing their common power supply via equipotential bridging combs
Cat. No. 0 375 46/47 (see 6.4).

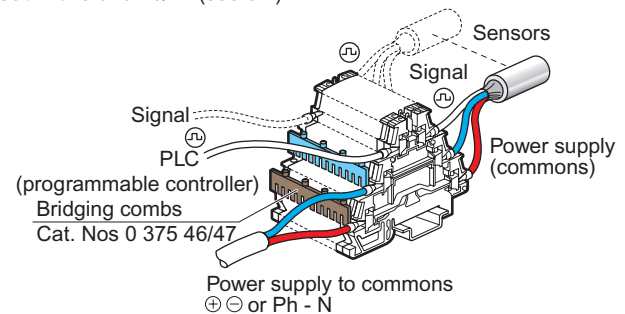

5. DIMENSIONS

Viking 3 blocks provide aesthetic terminal strips via:

- a single block profile from pitch 5 to 10,
- identical height of blocks from pitch 12 to 22 (compact block 70 mm2).

Cat. Nos. 0 371 00/01/02/03/20/21/30/31/60/61/62/63/77/78:

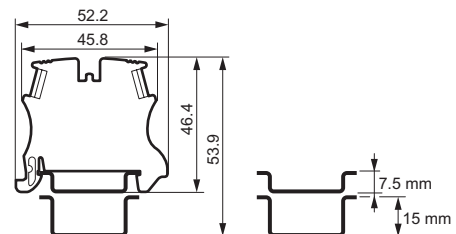

Cat. Nos 0 371 04/05/64/65/98/99:

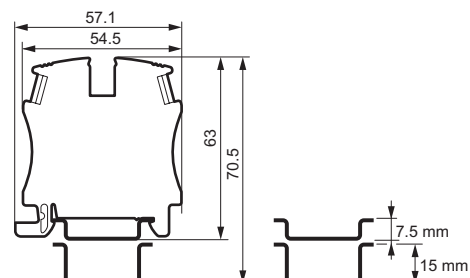

Viking 3 - Screw connection Connecting terminal blocks

Cat. Nos: 0 371 00/01/02/03/04/05/07/08/09/20/21/30/31
0 371 51/60/61/62/63/64/65/66/67/68/69/77/78
0 371 98/99

5. DIMENSIONS (continued)

Cat. No 0 371 66:

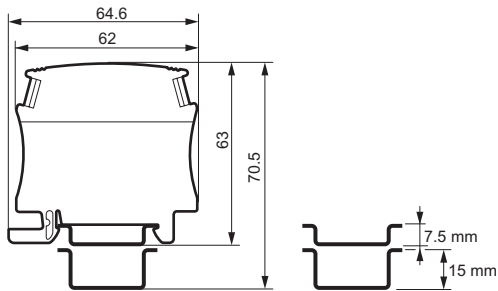

Cat. Nos 0 371 09/69:

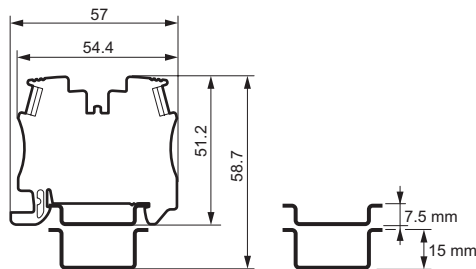

Cat. Nos 0 371 07/08/67/68:

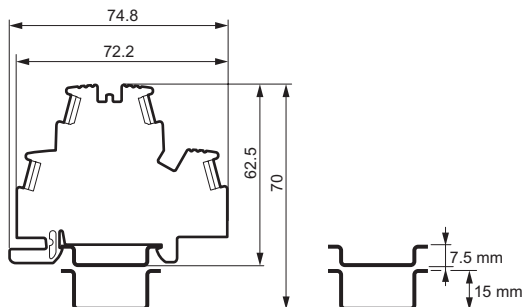

Cat. No 0 371 51:

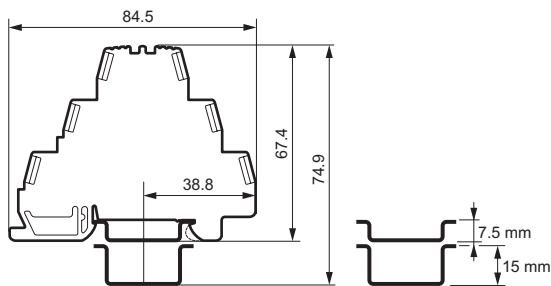

6. ACCESSORIES

6.1 End caps

Polyamide - dark grey, halogen free
V2 according to UL 94,
960°C according to IEC EN 60695-2-11.

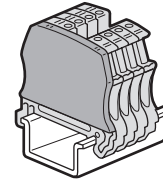

Cat. Nos	For blocks	Thickness (mm)
0 375 50	1 entry /1 outlet - Pitch 5/6/8/10	2
0 375 51	1 entry /1 outlet - Pitch 12/15	2.5
0 375 52	2 entries / 2 outlets	2
0 375 53	2 levels	2
0 375 54	3 levels	2.5

End stop Cat. No. 0 375 10 can also be used as an end cap for blocks with 1 entry/1 outlet and pitch 5/6/8/10 mm (see 6.12).

6.2 Separation and insulating dividers

Polyamide - dark grey, halogen free
V2 according to UL 94,
960°C according to IEC EN 60695-2-11.

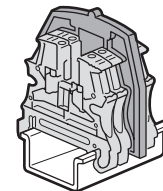

Cat. Nos	For blocks	Thickness (mm)
0 375 60	1 entry /1 outlet - Pitch 5/6/8/10	2.5
0 375 61	1 entry /1 outlet - Pitch 12/15	2.6
0 375 62	2 entries / 2 outlets	2.5
0 375 63	2 levels	2.5
0 375 64	3 levels	2.5

6.3 Equipotential bridging combs

- Front mounting with automatic insertion, screwless for faster fitting,
- Insulated and separable,
- For consecutive or alternating connection,
- Tin-plated copper and coloured polyamide.

Cat. Nos	Colour	Capacity	Cross-section (mm ²)
0 375 00 ⁽¹⁾	Blue	10 blocks - Pitch of 5	2.5
0 375 01 ⁽¹⁾	Red	10 blocks - Pitch of 5	2.5
0 375 02 ⁽¹⁾	Red	2 blocks - Pitch of 5	2.5
0 375 03	Blue	10 blocks - Pitch of 6	4
0 375 04	Red	10 blocks - Pitch of 6	4
0 375 05	Red	2 blocks - Pitch of 6	4
0 375 07	Red	3 blocks - Pitch of 8	6
0 375 08	Red	2 blocks - Pitch of 8	6

⁽¹⁾ Block Cat. No. 0 371 51: top level only.

Viking 3 - Screw connection

Connecting terminal blocks

Cat. Nos: 0 371 00/01/02/03/04/05/07/08/09/20/21/30/31
0 371 51/60/61/62/63/64/65/66/67/68/69/77/78
0 371 98/99

6.ACCESSORIES (continued)

6.3 Equipotential bridging combs (suite)

Up to a pitch of 8 mm, blocks have two areas for equipotential bridging combs.

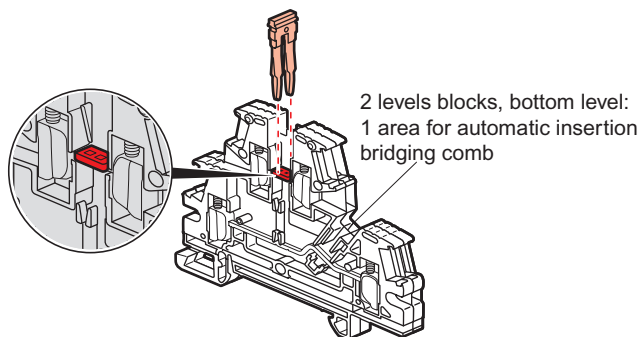
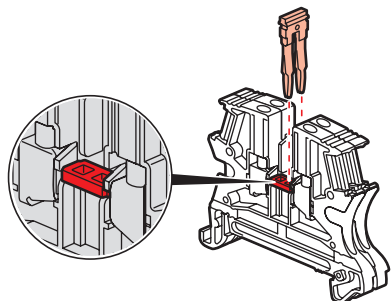

LEGRAND ADVANTAGE

Up to 8 mm pitch, the combs are the same for the Viking 3 screw connection and spring connection ranges.

The 2 areas enable tapping off for a continuous equipotential link of more than 10 blocks.

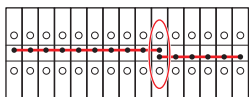

The insulated combs maintain the insulation voltages of the connecting terminal blocks.

When there are 2 groups of shunted blocks side by side:

- A separation and insulation divider must be inserted between the 2 groups to maintain the initial insulation voltage.

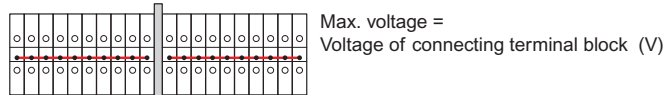

Separation and insulation divider

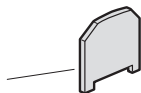

- Otherwise, the voltage will be derated:

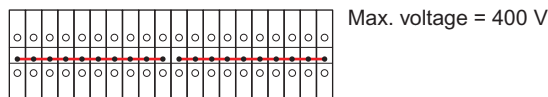

If the comb is cut to length, it is essential to use a separation and insulation divider to maintain the insulation voltage:

Max. voltage = Voltage of connecting terminal block (V)

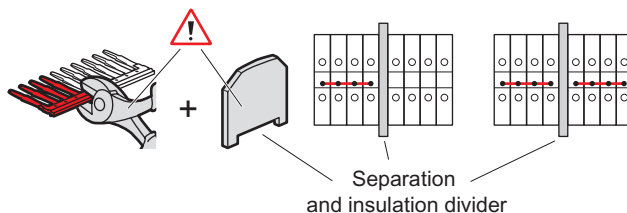

The voltage is derated in the case of an alternating connection configuration:

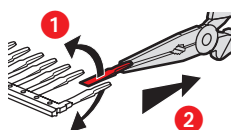

Max. voltage = 400 V

Max. voltage = 250 V⁽¹⁾

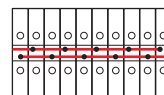
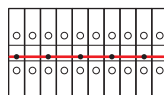

⁽¹⁾ Blocks 0 371 00/07/20/30/51/60/67 : 200V max.

6.4 Equipotential bridging combs for sensor blocks Cat. No. 0 371 51

- Side assembly for bottom and intermediate levels,
- Insulated and separable,
- Tin-plated copper and coloured polyamide.

Cat. Nos	Colour	Capacity	Cross-section (mm ²)
0 375 46	Brown	12 blocks - Pitch of 5	2.5
0 375 47	Blue		2.5

See wiring diagram in 4.1.1

It is essential to use a separation and insulation divider between 2 groups of shunted blocks to maintain the insulation voltage of the block.

6.5 Equipotential bridging bars

- Front mounting with screws,
- Bare, pre-assembled (captive spacer),
- For consecutive or alternating connection,
- Tin-plated brass.

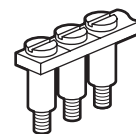

Cat. Nos	Capacity	Cross-section (mm ²)	Tightening torque (Nm)	Screwdriver, blade ø (mm)
0 375 40	12 blocks - Pitch of 10	10	0.9	3.5
0 375 42	12 blocks - Pitch of 12	16		4
0 375 44	12 blocks - Pitch of 15	35		4

In the case of a consecutive connection, it is essential to use a separation and insulation divider to maintain the insulation voltage of the block.

The voltage is derated in the case of an alternating connection configuration:



⁽¹⁾ Blocks 0 371 03/63 : 250 V max.

Viking 3 - Screw connection

Connecting terminal blocks

Cat. Nos: 0 371 00/01/02/03/04/05/07/08/09/20/21/30/31
0 371 51/60/61/62/63/64/65/66/67/68/69/77/78
0 371 98/99

6.ACCESSORIES (continued)

6.6 Protective screens

750°C according to IEC EN 60695-2-11.

6.6.1 Single-pole

Clear polycarbonate

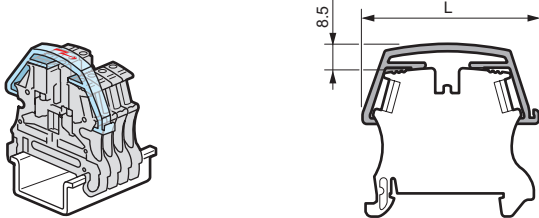

Cat. Nos	For block with 1 entry/1 outlet	L (mm)
0 375 65	Pitch of 5/6	58
0 375 66	Pitch of 8/10	
0 375 67	Pitch of 12/15	69

6.6.2 For cutting to length

Length: 1 m

Clear polycarbonate.

Takes CAB 3 markers: 0.15 to 0.5 mm² and 0.5 to 1.5 mm².

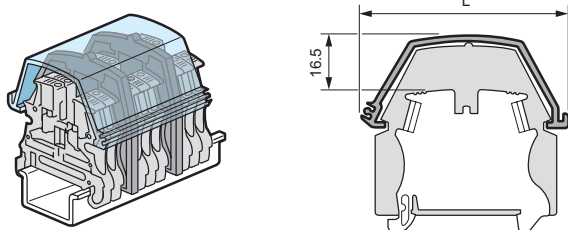

Cat. Nos	For blocks with 1 entry/1 outlet	Fits onto separation and insulating divider	L (mm)
0 375 68	Pitch of 5/6/8/10	0 375 60	66
0 375 69	Pitch of 12/15	0 375 61	76

6.7 Measurement accessories

6.7.1 Measurement sockets

Cat. Nos	For blocks	For plug Ø (mm)
0 375 27 ⁽¹⁾	Pitch of 5/6/8	4
0 375 75	Pitch of 10	2
0 375 76	Pitch of 12/15	4

⁽¹⁾ Block with 2 and 3 levels: top level only.

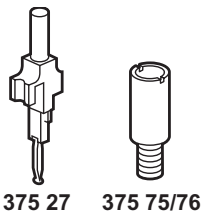

The socket Cat. No 0 375 27 is mounted in one of two areas for equipotential bridging comb (automatic insertion). Its particular shape allows the measurement on a block equipped with a comb. The mounting of 2 sockets Cat. No 0 375 27 side by side is only possible with 8 mm pitch blocks.

6.7.2 IP2X safety tip adaptor, Cat. No. 394 45

- Test plug Ø 2 mm - retractable tube,
- For performing ad-hoc tests according to regulations on the protection of workers,
- Fixes directly on Ø 4-mm plug.



6.8 Shielding accessories

These accessories ensure a safe and simple connection of cable shielding.

6.8.1 Screening continuity bracket, Cat. No. 0 375 35

For blocks with 1 entry/1 outlet - Pitch 5/6/8/10 mm. Connected with 2.8 x 0.8-mm clips or welded on. Capacity: 1 mm².

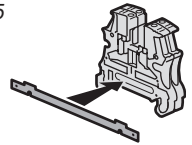

6.8.2 Shielding clamps

Cat. Nos	For cables Ø (mm)
0 375 30	3 to 8
0 375 31	4 to 13.5
0 375 32	10 to 20



Fixing on bar
10 x 3
Cat. No 0 375 34

Fixing on rail
with accessory
Cat. No 0 364 69

Fixing on plate
with M4 screws
(supplied)

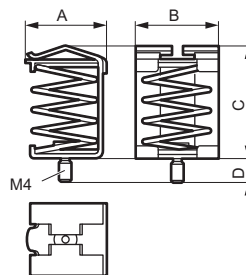
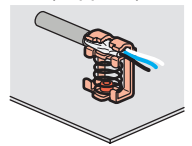
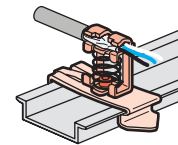
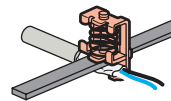

Cat. Nos	Dimensions (mm)			
	A	B	C	D
0 375 30	13.5	18	26	5.6
0 375 31	20	20.3	31.4	5.3
0 375 32	24.8	26	40	5.3

6.8.3 Shielding bar, Cat. No. 0 375 34

- For use with end stops Cat. No. 0 375 12 (see 6.12)
- 10 x 3 mm,
- Length 1 m,
- Steel.

Shielding terminal strip with end stops, Cat. No. 0 375 12, bar Cat. No. 0 375 34 and clamps Cat. Nos. 0 375 30/31:

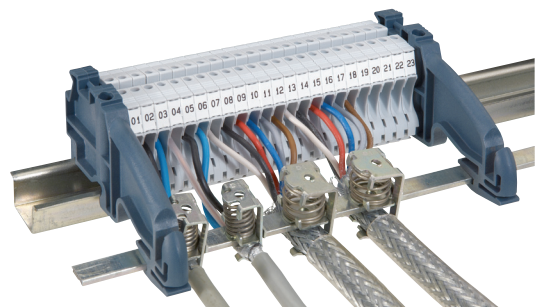

6.9 Rails

- Length 2 m,
- Galvanized steel.

Cat. Nos	Rail
0 374 04	EN 60715 depth 7.5 mm
0 374 07	Depth 15 mm
0 477 22	Depth 7.5 mm with oblong holes
0 477 23	Depth 15 mm with oblong holes

Viking 3 - Screw connection Connecting terminal blocks

Cat. Nos: 0 371 00/01/02/03/04/05/07/08/09/20/21/30/31
0 371 51/60/61/62/63/64/65/66/67/68/69/77/78
0 371 98/99

6.ACCESSORIES (continued)

6.10 45° mounting bracket, Cat. No. 0 394 49

- Set of 2 brackets providing a 45° rail angle,
- Galvanized steel,
- Supplied with 4 M6 screws, nuts and washers.

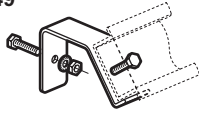





6.11 Adaptor for fixing on asymmetrical rail, Cat. No. 0 364 66

- For fitting blocks on rail 
- Width 17 mm,
- Increases the height of the block by 6 mm,
- PC/ABS 960°C according to IEC EN 60695-2-11.

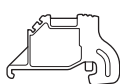
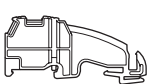

6.12 End stops

				
Cat. Nos	0 375 10	0 375 11	0 375 12	0 375 13
Pitch (mm)	6	8	10	12
For rails	 Depth 15 mm  EN 60715 Depth 7.5 mm and 15 mm			 EN 60715

Cat. No 0 375 10: Screwless automatic mounting
Acts as an end cap for blocks with 1 entry/1 outlet and pitch 5/6/8/10.

Cat. No 0 375 12: End stop for bar bracket, protection or shielding conductor.

Note: other characteristics are listed in the specific end stops technical data sheet.

6.13 Marking

CAB 3 markers:

International colour code digits, letters, conventional symbols.

Terminal block marking capacity:

- 4 CAB 3 markers 0.15 to 0.5 mm², up to 7 markers with marker holder Cat. No. 0 383 92,
- 3 CAB 3 markers 0.5 to 1.5 mm², up to 6 markers with marker holder Cat. No. 0 383 92.



The CAB 3 range provides consistency of marking on both terminal blocks and wiring.

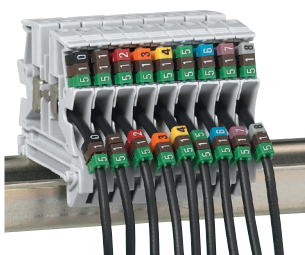

Pre-printed markers:

- For blocks with pitch 5/6/8,
- Provided as pre-cut plates,
- Digits and numbers,
- Horizontal or vertical reading,
- Rapid marker fitting via band on terminal strip.

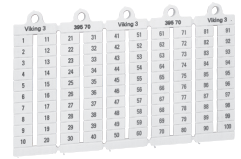

Blank markers:

- Cat. No. 0 395 00 for blocks with pitch 5.
- Cat. No. 0 395 01 for blocks with pitch 6.
- Cat. No. 0 395 02 for blocks with pitch 8.
- Provided as pre-cut plates,
- Permanent marking with black felt-tip pen Cat. No. 0 395 98,
- Rapid marker fitting via band on terminal strip.

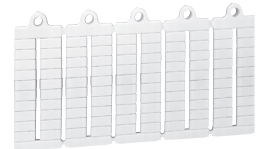

LEGRAND'S ADVANTAGE

The single length of the marking areas on Viking 3 blocks allows markers to be fitted singly on a block with a pitch larger than the marker.

Example: Marker Cat. No. 0 395 00 can be fixed on a block with pitch 12.