

<p>12-15 V$\overline{\text{---}}$</p>	<p>MONO 1 x 1 W STEREO 2 x 1 W</p>	<p>87,5 MHz ↓ 108 MHz</p>	<p>10 max.</p>

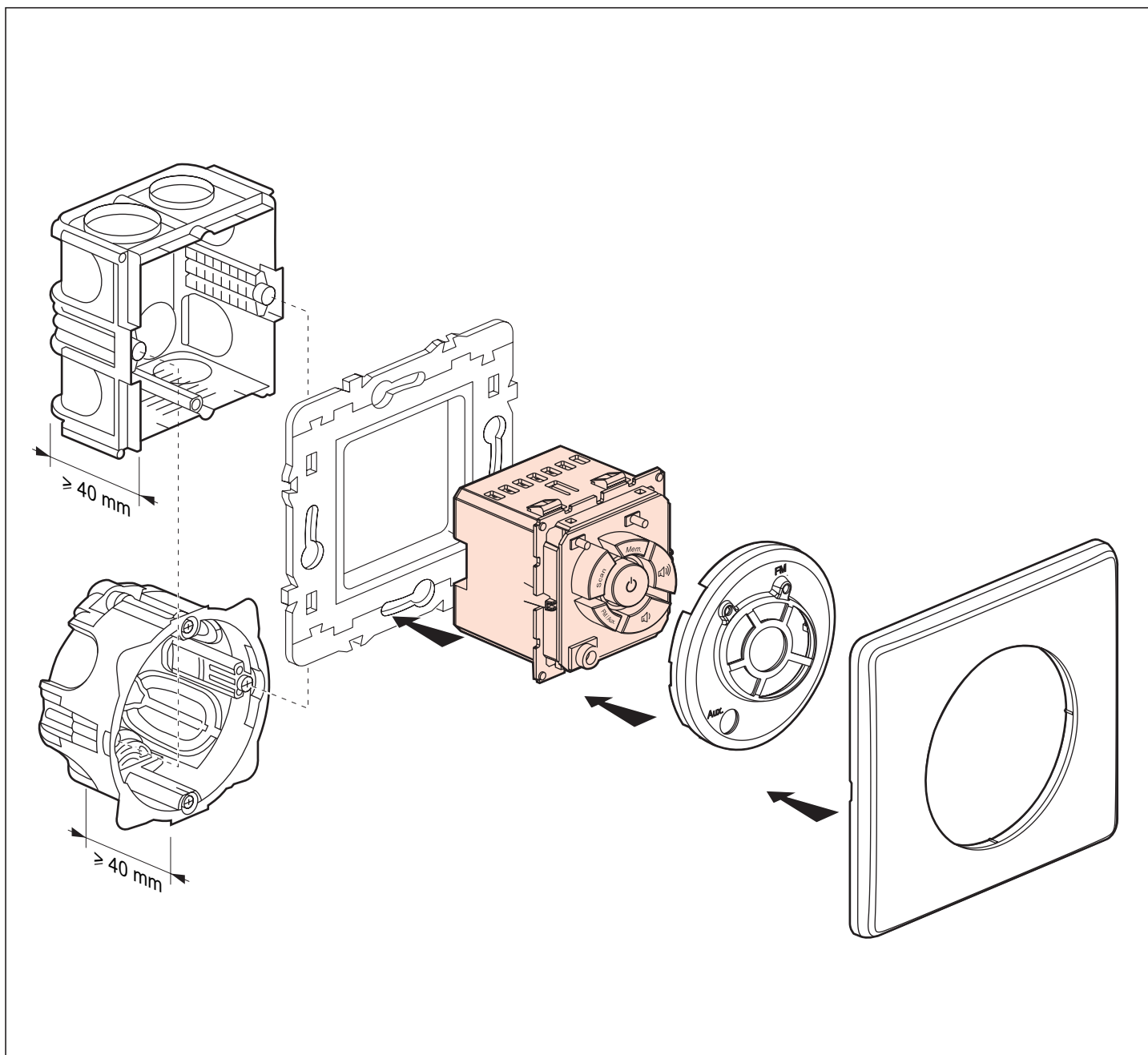

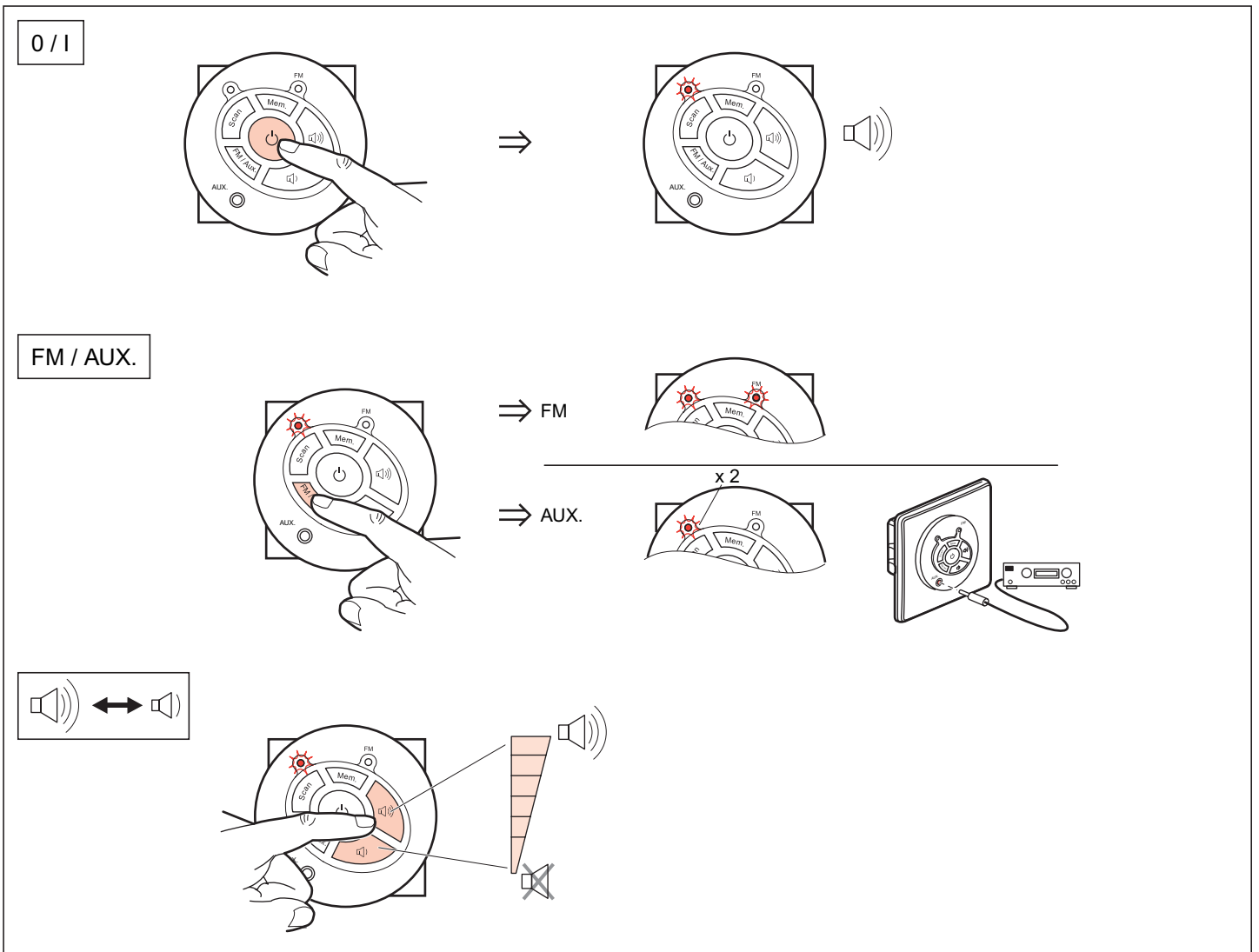

FM → SCAN

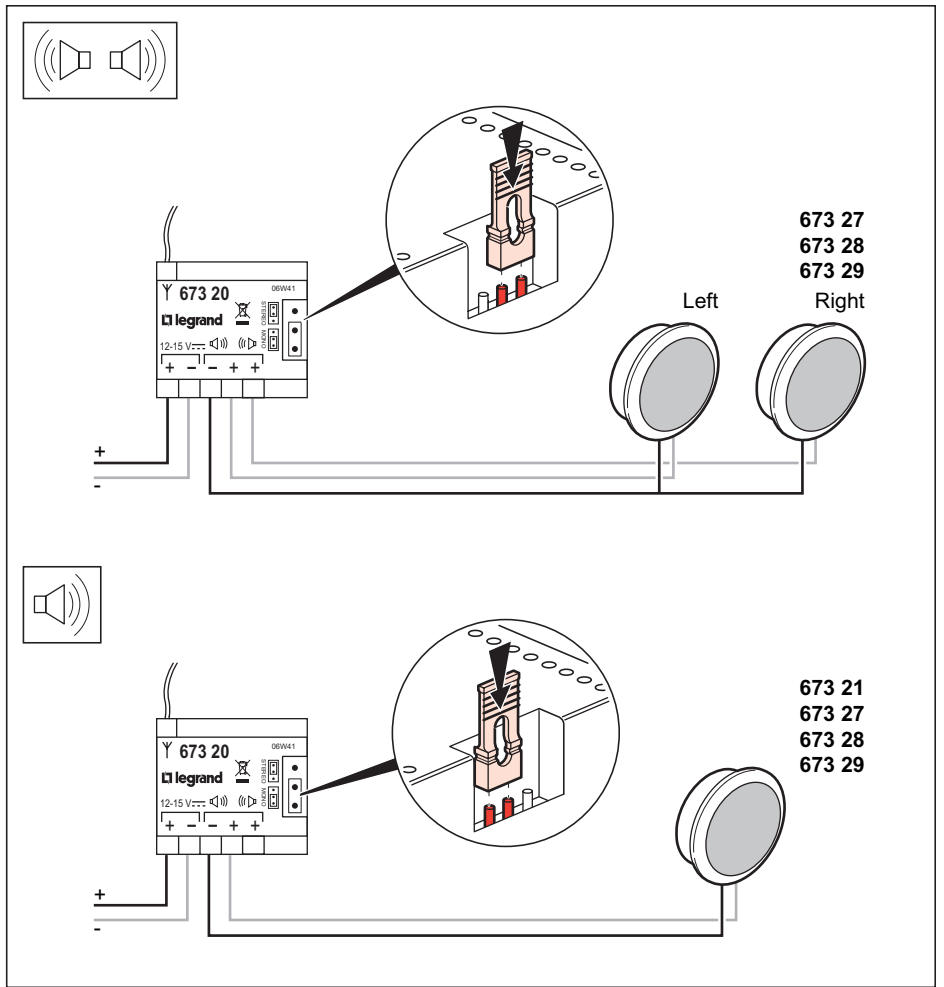
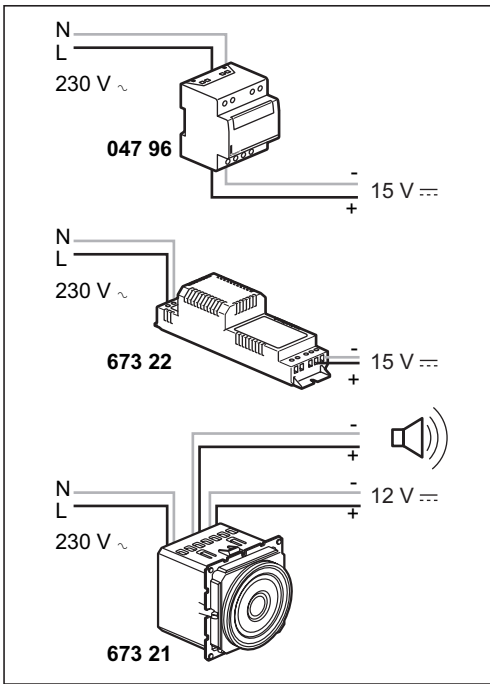
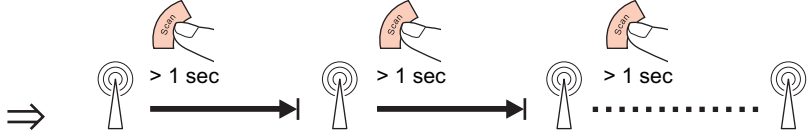
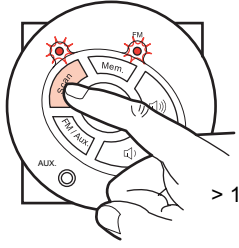
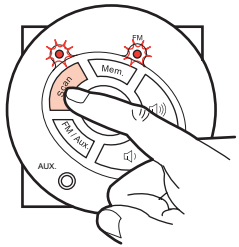

> 1 sec

FM → MEM

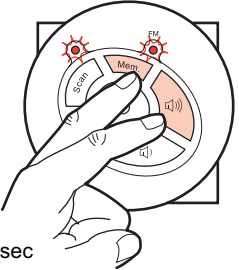

5 sec

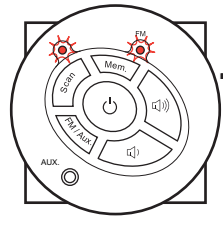
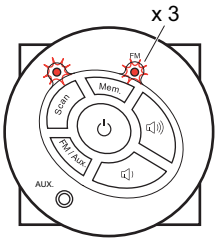

FM MEM

FM → MEM AUTO

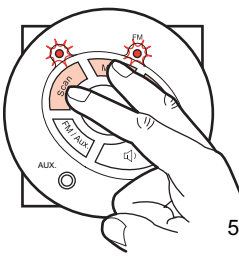

5 sec

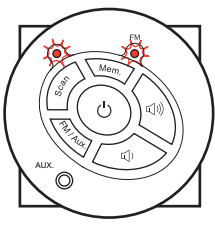

- FM MEM 1
- FM MEM 2
- ...
- FM MEM 10

SELECTION MEM

FM MEM 1

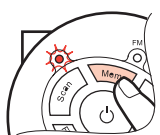

FM MEM 2

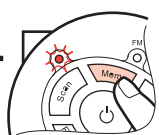

FM MEM 10

FM → ~~MEM~~

FM MEM

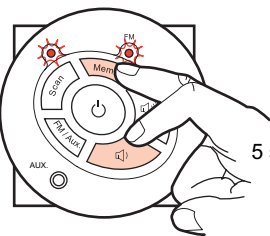

5 sec

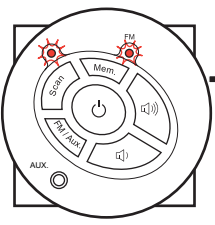
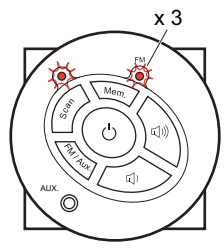

~~FM MEM~~

 → SENSITIVITY
FM

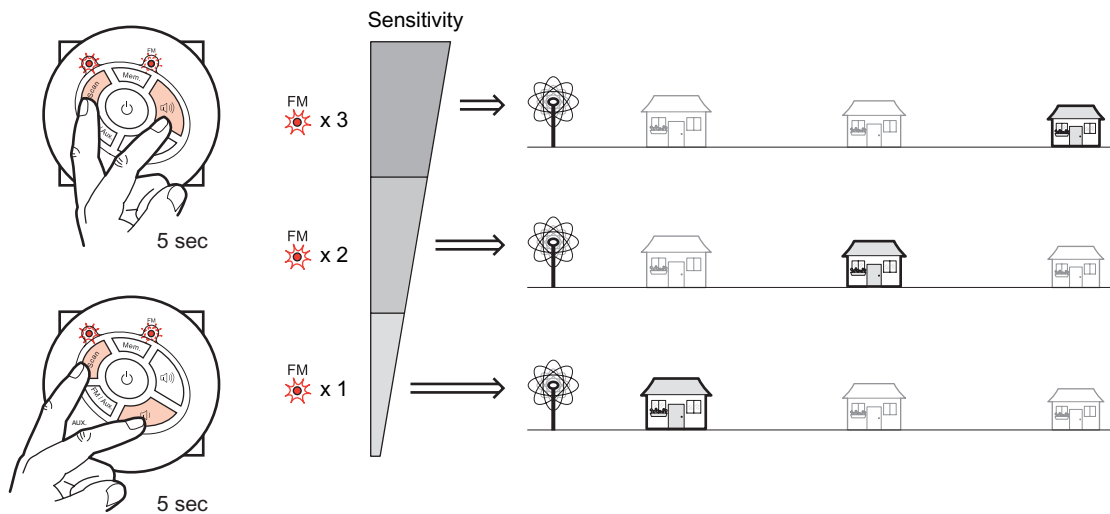

Si malgré les réglages, la qualité de réception reste mauvaise, nous consulter.

 1 → 0

