

Caractéristiques techniques

U	230 V ~ - 50 / 60 Hz
F	433,92 MHz
I	14 mA
	32 mA - 250 V - 5 x 20 F
	-10 < < +55 °C

Utilisation

489 70	1800 W	1800 W	1000 VA	1000 VA
489 72/73	8 A - 230 V ~	8 A - 230 V ~	1000 VA	1000 VA

Fonctionnement à distance

Émetteurs utilisables						
	489 06 489 10 489 12	489 00 489 01 489 03	882 80	841 05 841 06 841 07	746 06 746 07	916 13
	489 70 / 72 / 73					

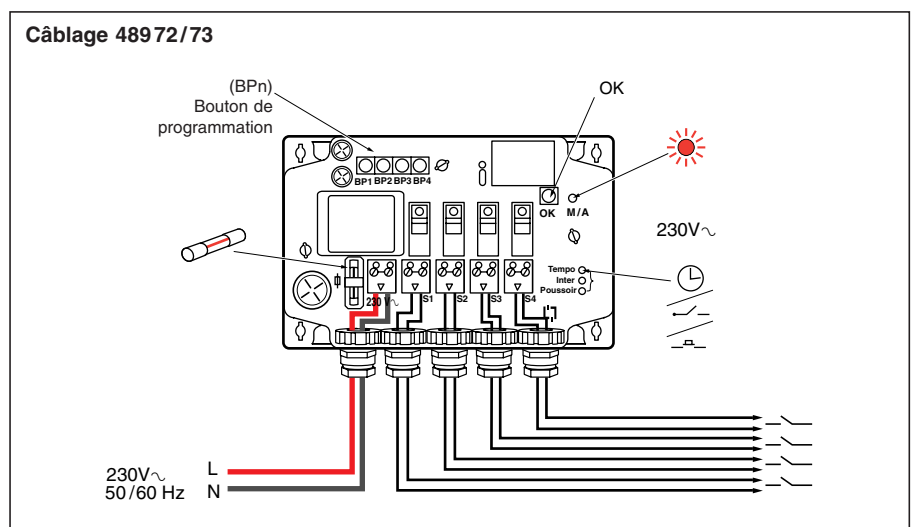
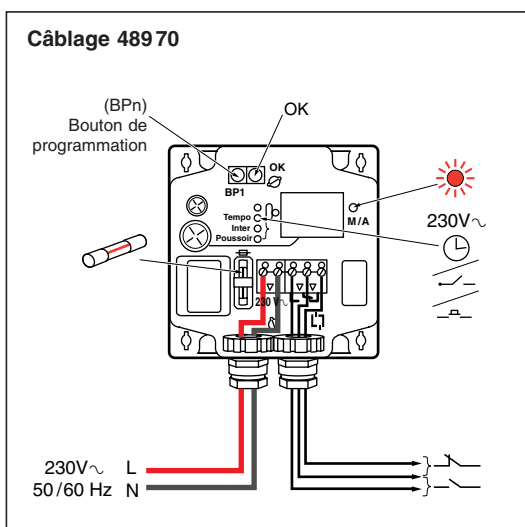
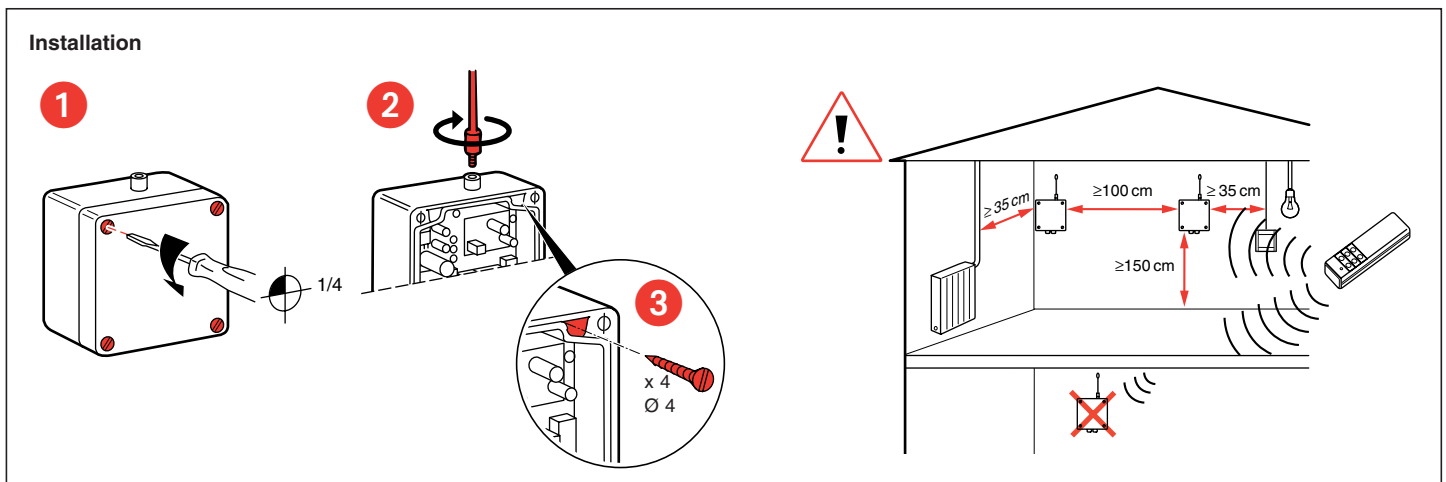

Ce produit peut mémoriser 16 codes Allumage et 16 codes Extinction différents par sortie. Cependant, le panachage du mode de fonctionnement n'est pas possible. Le mode de fonctionnement Temporisation, Interrupteur ou Poussoir sera identique pour tous les codes mémorisés sur une sortie.

Important :

Après un appui sur le BPn > 2 secondes le voyant M/A clignote pour signaler le passage en mode apprentissage.

Si le voyant clignote très rapidement à 3 reprises, après avoir relâché le BPn, cela signifie qu'il n'est plus possible d'apprendre un code supplémentaire au récepteur. 2 possibilités s'offrent à l'utilisateur : soit renoncer à l'apprentissage d'un émetteur supplémentaire, soit effacer tous les codes et procéder à l'apprentissage de 16 nouveaux codes.

Ne pas dépasser un délai de 30 secondes entre deux appuis sur une touche, sinon le récepteur quitte automatiquement le mode apprentissage.

Pictogrammes de programmation

	Appuyer sur le bouton indiqué		Le voyant indiqué est éteint
	Appuyer plus de 2 secondes		Le voyant indiqué clignote
	Relâcher le bouton		Le voyant indiqué flashe
			Le voyant indiqué est allumé

Choix du mode de fonctionnement

Mode minuterie : > 2 s < 8 mn 30 s

Mode interrupteur :

Mode poussoir :

Le changement de mode est obtenu par appuis successifs sur la touche BPn.

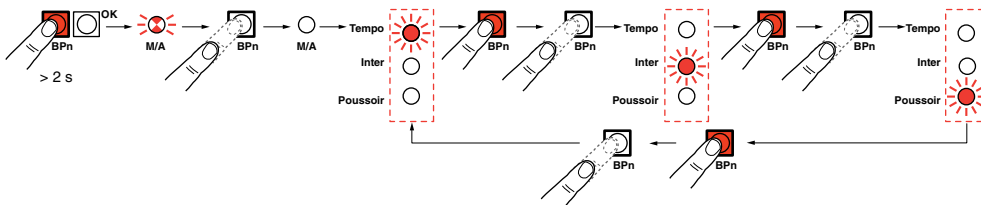

Apprentissage du mode Interrupteur

Important :

Il est possible de commander un récepteur par 2 touches différentes d'un émetteur (utilisation en interrupteur A) ou par une seule touche d'un émetteur (utilisation en télérupteur B). Cependant l'utilisation en interrupteur est préférable si l'environnement est perturbé.

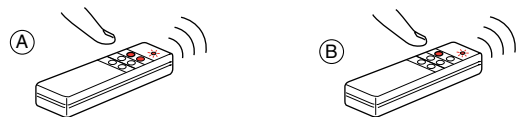

Sélection du mode

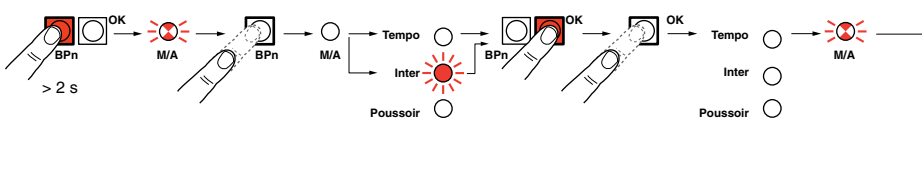

Apprentissage du code marche

Apprentissage du code arrêt

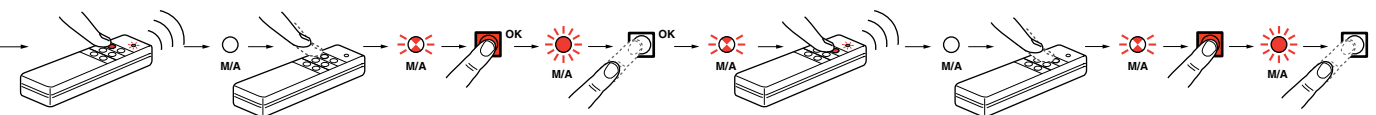

Apprentissage d'un code d'extinction seul



L'apprentissage d'un code d'extinction seul permet, si ce code est appris à plusieurs récepteurs de réaliser une extinction générale.

Apprentissage du mode Poussoir

Sélection du mode

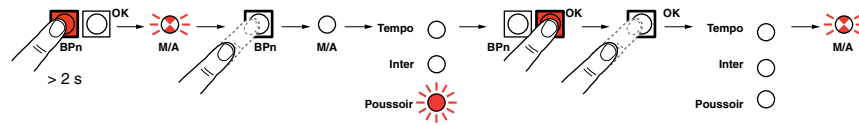

Apprentissage du code

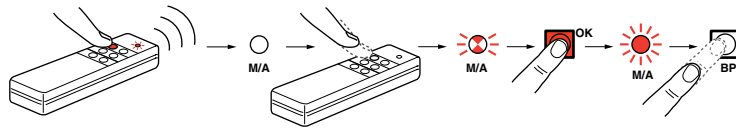

Apprentissage du mode Temporisation

Sélection du mode

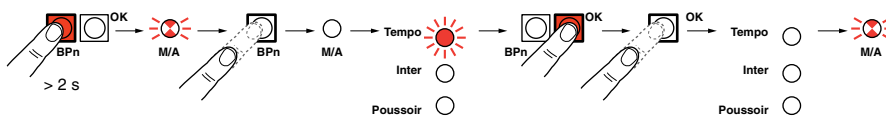

Apprentissage du code marche

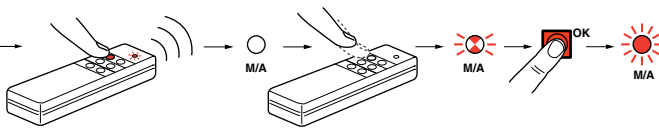



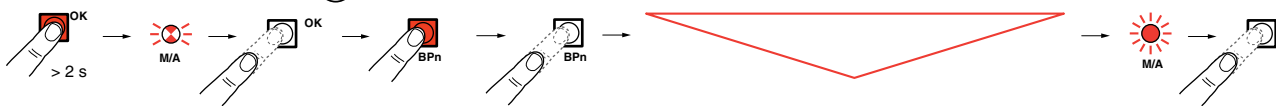

Réglage de la temporisation (> 2 s < 8 mn 30 s)



Nota :

Le voyant M/A clignote toutes les 4 s.
Exemple : 1 minute = 15 allumages.
Pour des durées plus longues, procéder par chronométrage.
Si la validation sur «OK» n'est pas effectuée, la temporisation se règle sur 8 mn 30 s.

 < 4 s > 		
x 5	20 s	OK
x 10	40 s	OK
x 15	1 mn	OK
x 30	2 mn	OK
x 60	4 mn	OK
x (X)	8 mn 30s	—

Apprentissage du mode Téléviateur

Sélection du mode

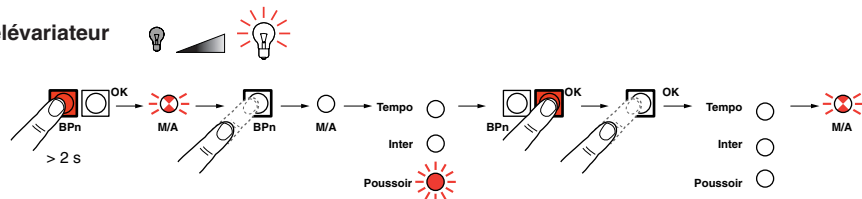

Apprentissage du code marche /variation

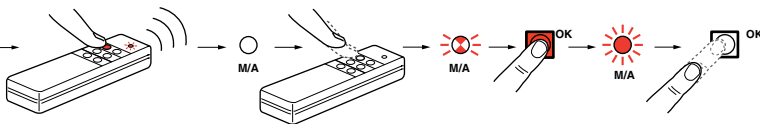

Important :

Ne pas utiliser la même touche de télécommande pour le code marche/variation et le code marche/arrêt.

Apprentissage du code marche/arrêt

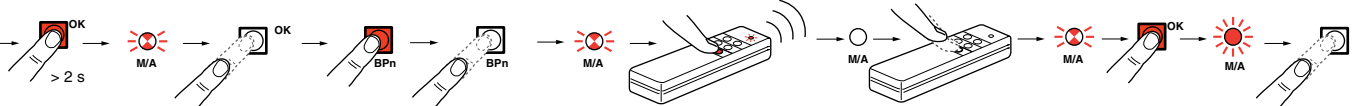

Fonctionnement

Marche /variation

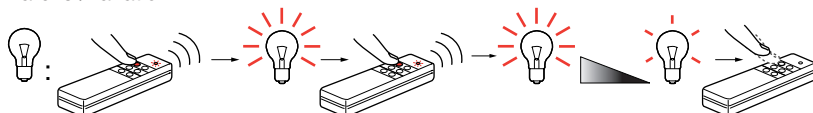

Marche/arrêt

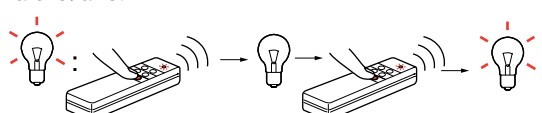

Effacement des codes

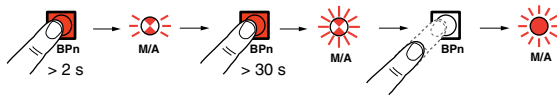

Important :
L'effacement provoque la perte de tous les codes d'une sortie.

Fonctionnement en mode local

En mode interrupteur : — — par des appuis brefs < 2s, le relais "n" se ferme puis s'ouvre successivement

En mode temporisation : ⌚ un appui bref < 2s sur "BPn", le relais "n" se ferme le temps de la temporisation

En mode poussoir — — ou téléviateur un appui très bref < 0,4s sur "BPn", le relais "n" se ferme pendant 0,4s, un appui bref (> 0,4s, < 2s) sur "BPn", le relais "n" se ferme pendant 4s environ.

Exemple de câblage avec téléviateur :

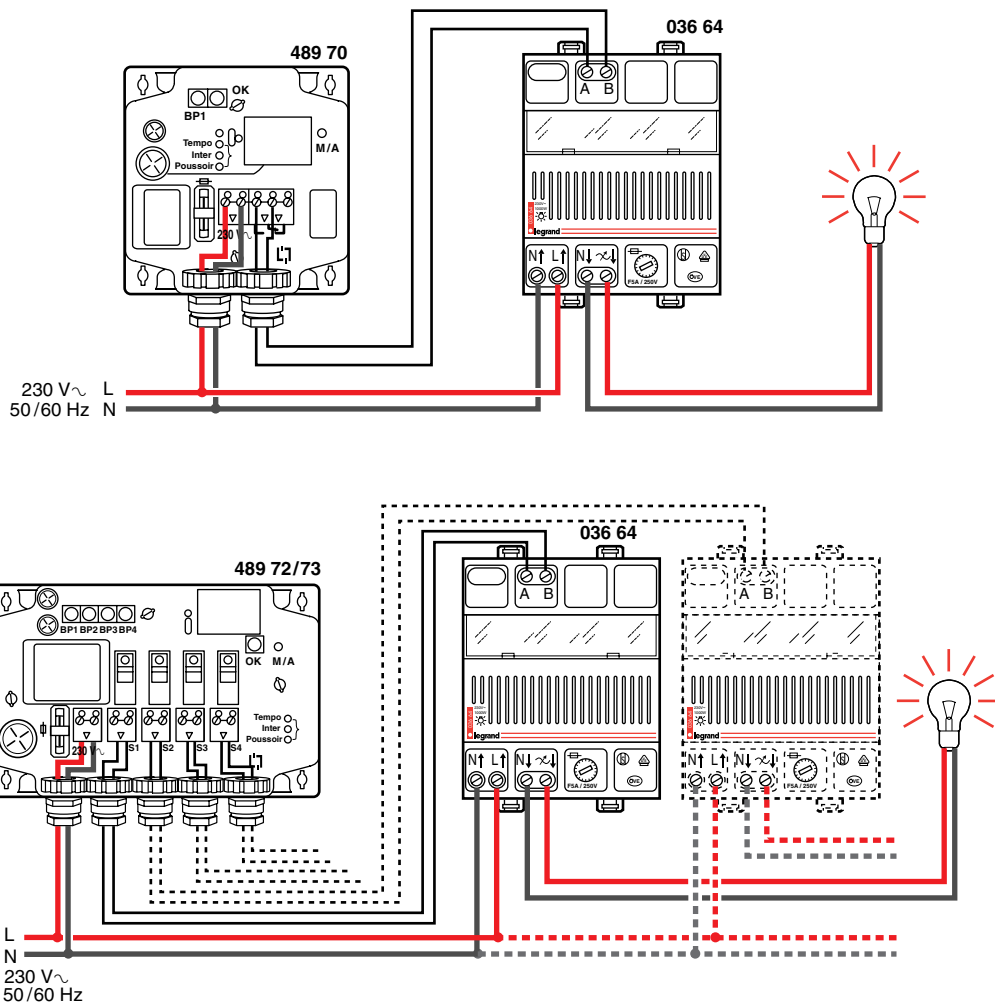

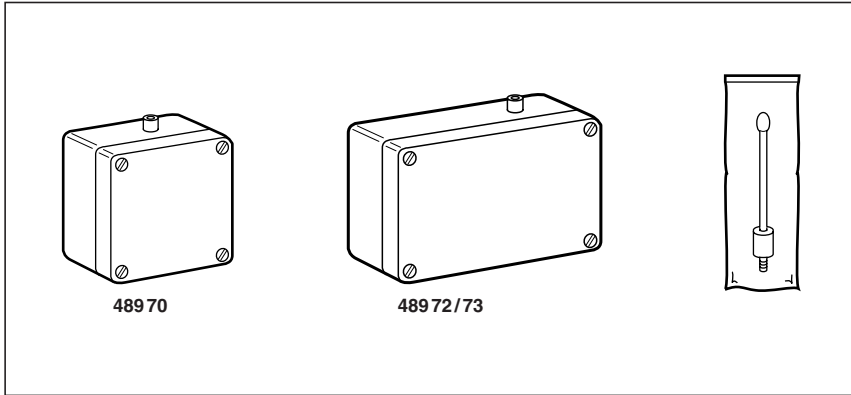

Technische eigenschappen

U	230 V ~ - 50 / 60 Hz
F	433,92 MHz
I	14 mA
	32 mA - 250 V - 5 x 20 F
	-10 < < +55 °C

Gebruik

489 70	1800 W	1800 W	1000 VA	1000 VA
489 72/73	8 A - 230 V ~	8 A - 230 V ~	1000 VA	1000 VA

Werking op afstand

Bruikbare zenders						
	489 06 489 10 489 12	489 00 489 01 489 03	882 80	841 05 841 06 841 07	746 06 746 07	916 13
	489 70 / 72 / 73					

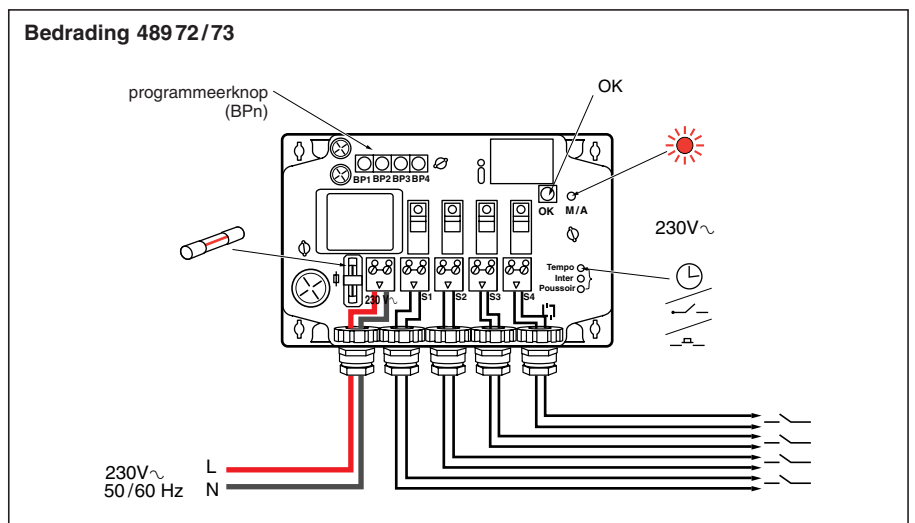
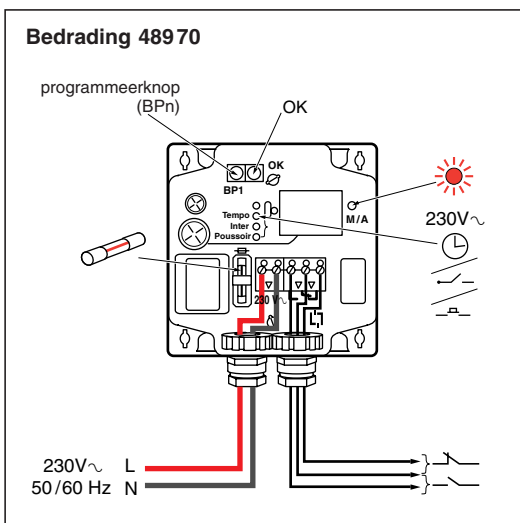
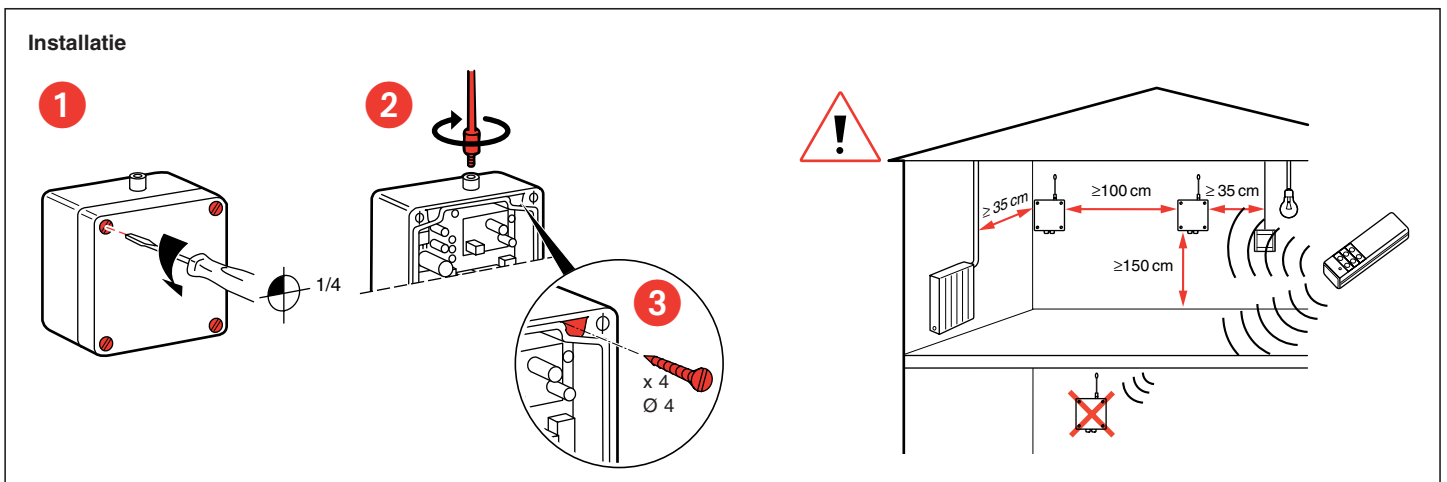

Dit product kan 16 aanschakelcodes en 16 uitschakelcodes memoriseren die verschillend zijn per uitgang. De werkwijzen kunnen echter niet gemengd worden. De werkwijze met Temporisatie, Schakelaar of Drukknop zal identiek zijn voor alle gememoriseerde codes per uitgang.

Belangrijk :

Nadat de knop BPn gedurende meer dan 2 seconden is ingedrukt, gaat de lamp M/A knipperen om aan te duiden dat er werd overgegaan naar de aanleerprocedure.

Indien de lamp zeer snel 3 maal achter elkaar knippert nadat u de knop BPn heeft losgelaten, dan wilt dat zeggen dat er geen extra code meer kan worden aangeleerd aan de ontvanger. De gebruiker heeft 2 mogelijkheden : ofwel wordt er geen bijkomende zender gememoriseerd, ofwel worden alle codes gewist en worden er 16 nieuwe codes aangeleerd. Laat niet meer dan 30 seconden verlopen voordat u een knop nogmaals indrukt, want anders zal de ontvanger automatisch de aanleerprocedure verlaten.

Programmeerpictogrammen

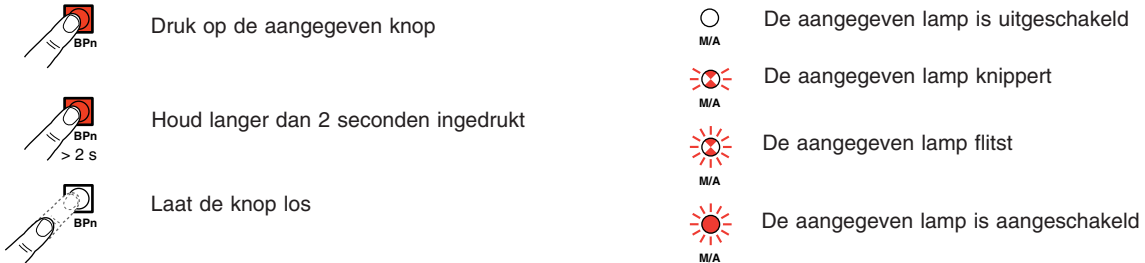

Mogelijke werkwijzen

Temporisatie : $> 2\text{ s}$  $< 8\text{ mn } 30\text{ s}$

Schakelaar : 

Drukknop : 

Er wordt overgegaan naar een andere procedure door herhaaldelijk op de toets BPn te drukken.

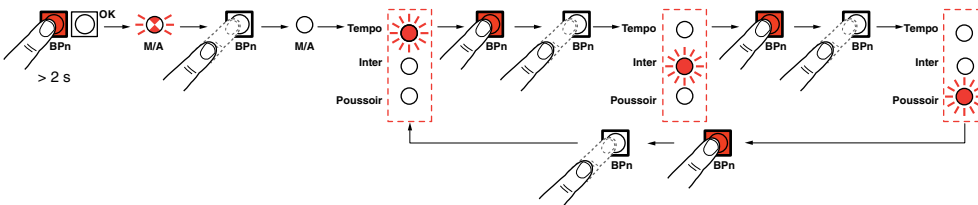

De werkwijze met schakelaar aanleren 

Belangrijk :

Het is mogelijk om een ontvanger te bedienen met 2 verschillende knoppen van een zender (gebruik als schakelaar A) of met één enkele knop van een zender (gebruik als teleruptor B). Het gebruik als schakelaar is echter verkozen indien de omgeving storingen ondervindt.

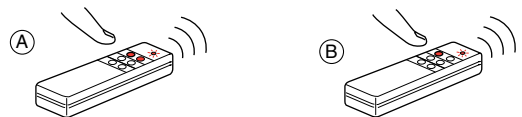

Selectie van de werkwijze

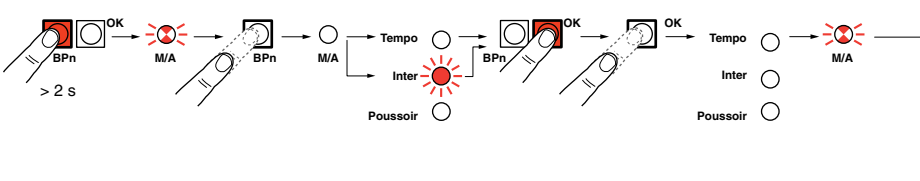

Aanleren van de aancode

Aanleren van de stopcode

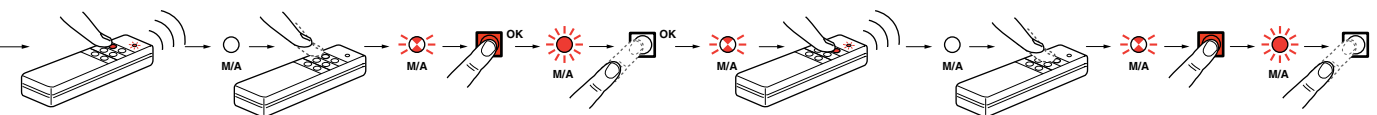

Aanleren van één enkele uitschakelcode

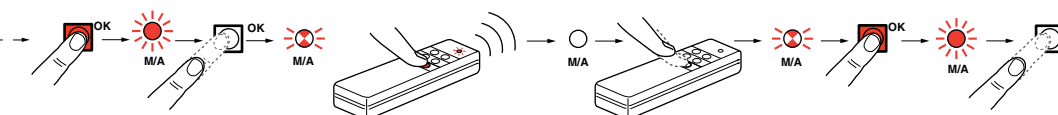

Door één enkele uitschakelcode aan te leren, wordt een algemene uitschakeling mogelijk, indien de code wordt aangeleerd aan verschillende ontvangers.

De werkwijze met drukknop aanleren

Selectie van de werkwijze

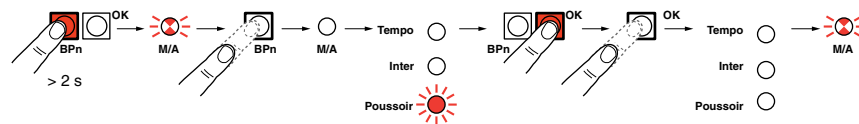

De code aanleren

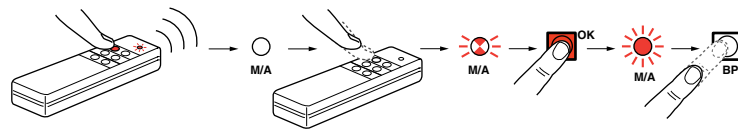

De werkwijze met temporisatie aanleren

Selectie van de werkwijze

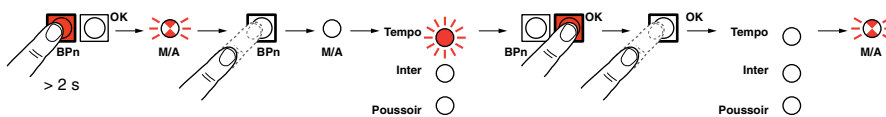

De startcode aanleren

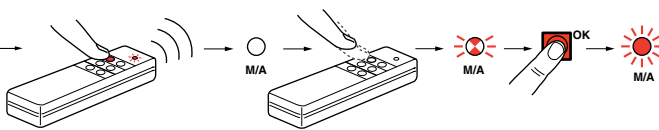

De temporisatie instellen (> 2 s < 8 min 30 s)

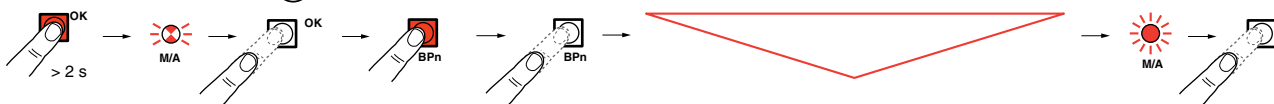

NB :

De lamp M/A knippert elke 4 s.
 Voorbeeld : 1 minuut = 15 knipperingen.
 Voor periodes van langere duur dient u de tijd op te meten met een chronometer.
 Indien er niet op «OK» wordt gedrukt, dan zal de temporisatie worden ingesteld op 8 min 30 s.

< 4 s >		
x 5	20 s	OK
x 10	40 s	OK
x 15	1 min	OK
x 30	2 min	OK
x 60	4 min	OK
x (X)	8 min 30s	—

De werkwijze met afstandsdimmer aanleren

Selectie van de werkwijze

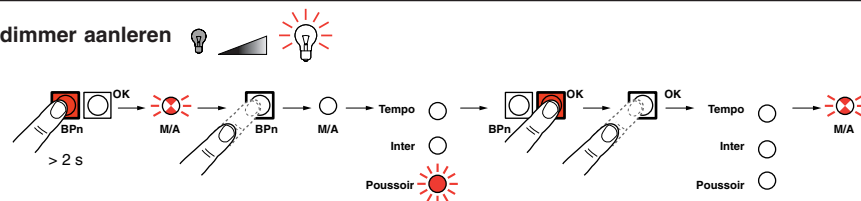

De code start/dimming aanleren

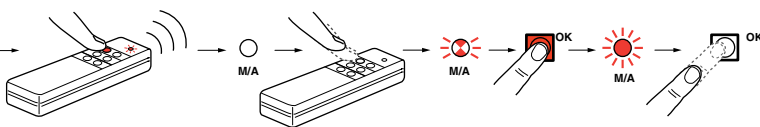

Belangrijk :
 Gebruik niet dezelfde knop van de afstandsbediening voor de start/dimming-code als voor de start/stop-code.

De start/stop-code aanleren

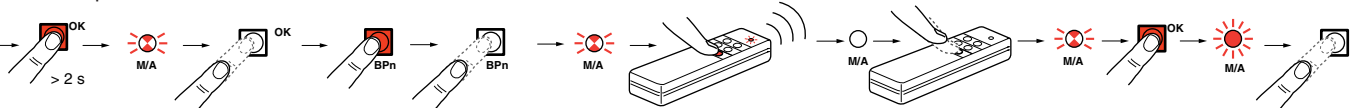

Werking

Start/dimming

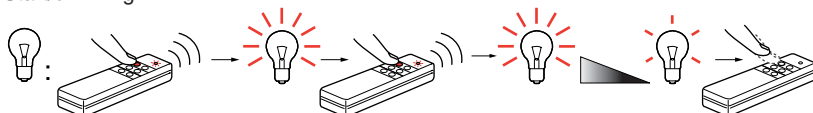

Start/stop

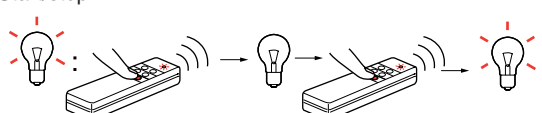

De codes wissen

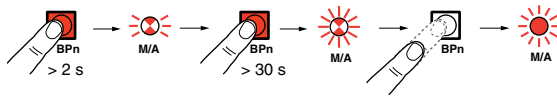

Belangrijk :
Bij het wissen zullen al de codes van één uitgang verdwijnen.

Werking van plaatselijke bediening

Schakelaar : door de knop een aantal maal kort in te drukken < 2s, gaat het relais "n" herhaaldelijk sluiten en weer openen

Temporisatie : door de knop "BPn" kort in te drukken < 2s gaat het relais "n" sluiten gedurende de temporisatietijd

Drukknop of afstandsdimmer : door de knop "BPn" heel kort in te drukken < 0,4s, gaat het relais "n" gedurende 0,4s, sluiten, door de knop "BPn" kort in te drukken (> 0,4s, < 2s), gaat het relais "n" gedurende ongeveer 4s sluiten.

Voorbeeld van bedrading met afstandsdimmer :

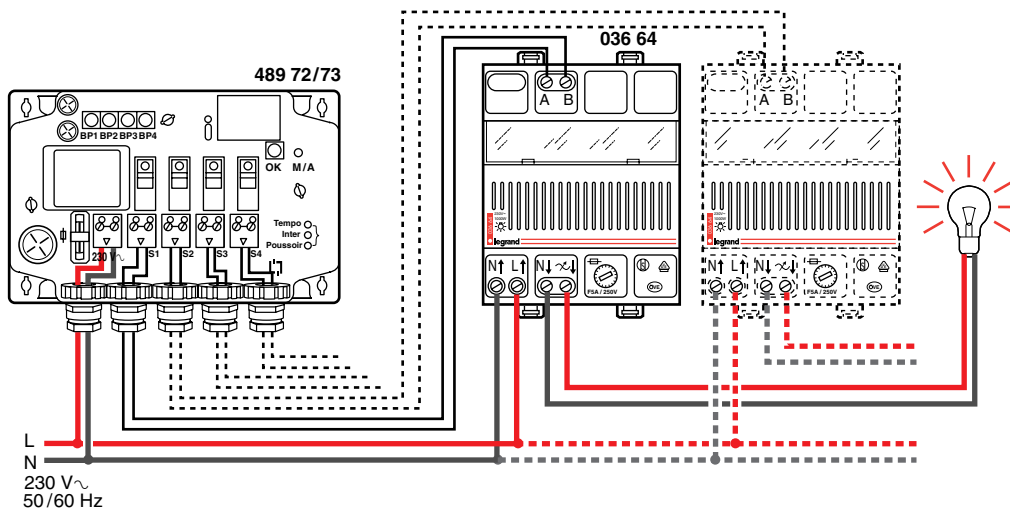
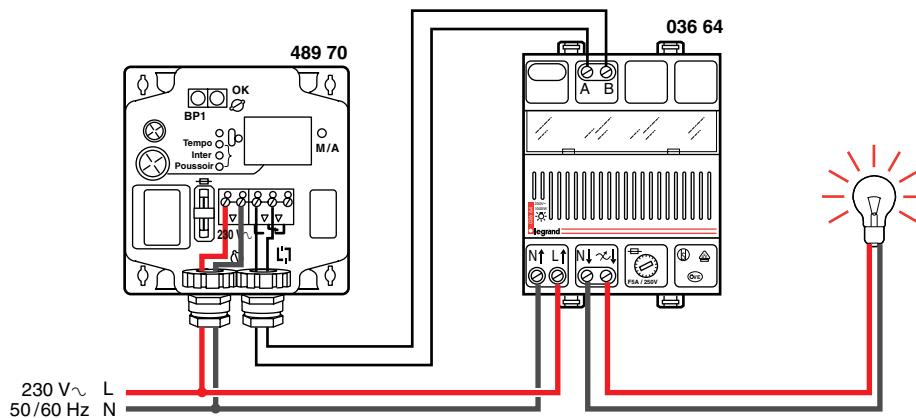

Plexo 55

CAD remote controlled radio receiver
489 70/72/73

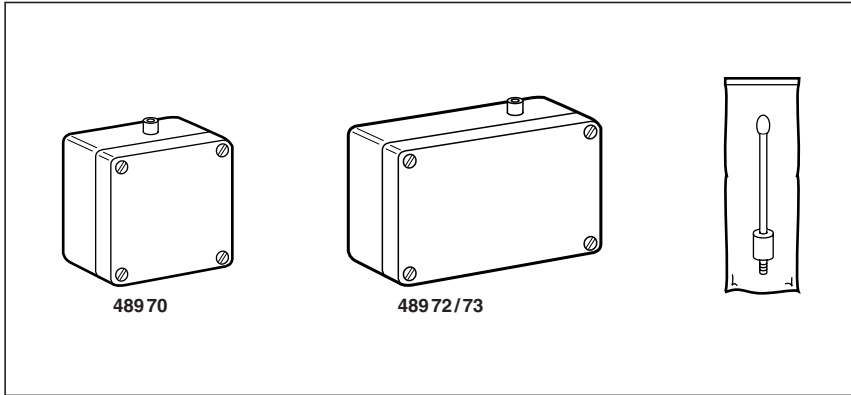

Technical specification

U	230 V ~ - 50 / 60 Hz
F	433,92 MHz
I	14 mA
	32 mA - 250 V - 5 x 20 F
	-10 < < +55 °C

Use

489 70	1800 W	1800 W	1000 VA	LED
489 72/73	8 A - 230 V ~	8 A - 230 V ~	1000 VA	LED

Remote operation

Possible transmitters						
	489 06 489 10 489 12	489 00 489 01 489 03	882 80	841 05 841 06 841 07	746 06 746 07	916 13
	489 70 / 72 / 73					

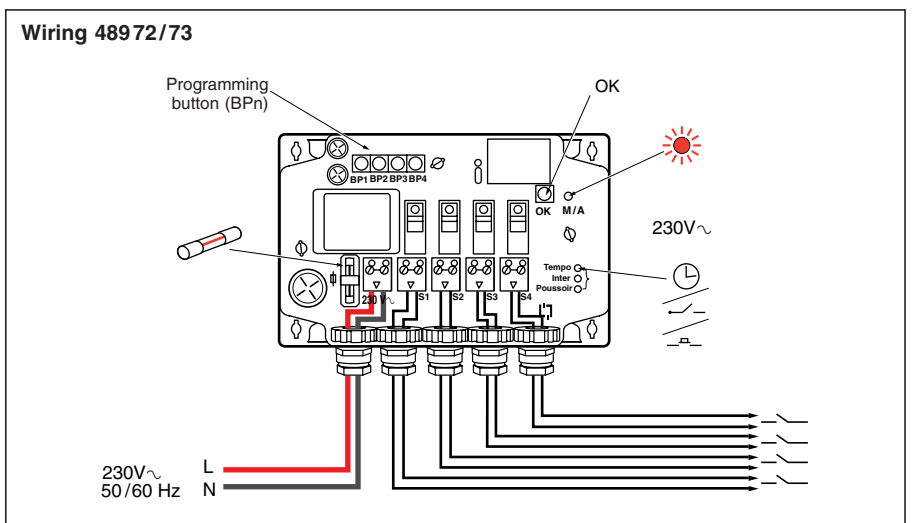
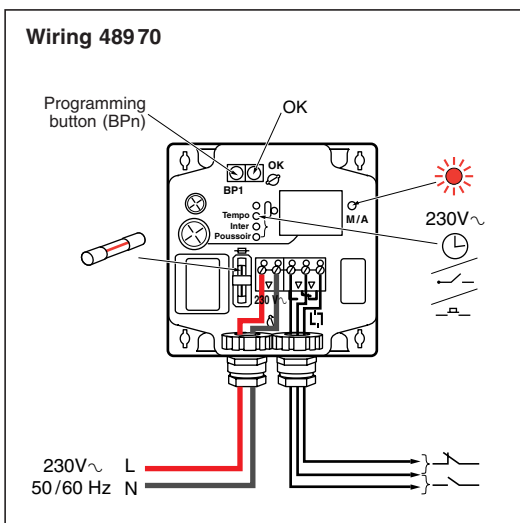
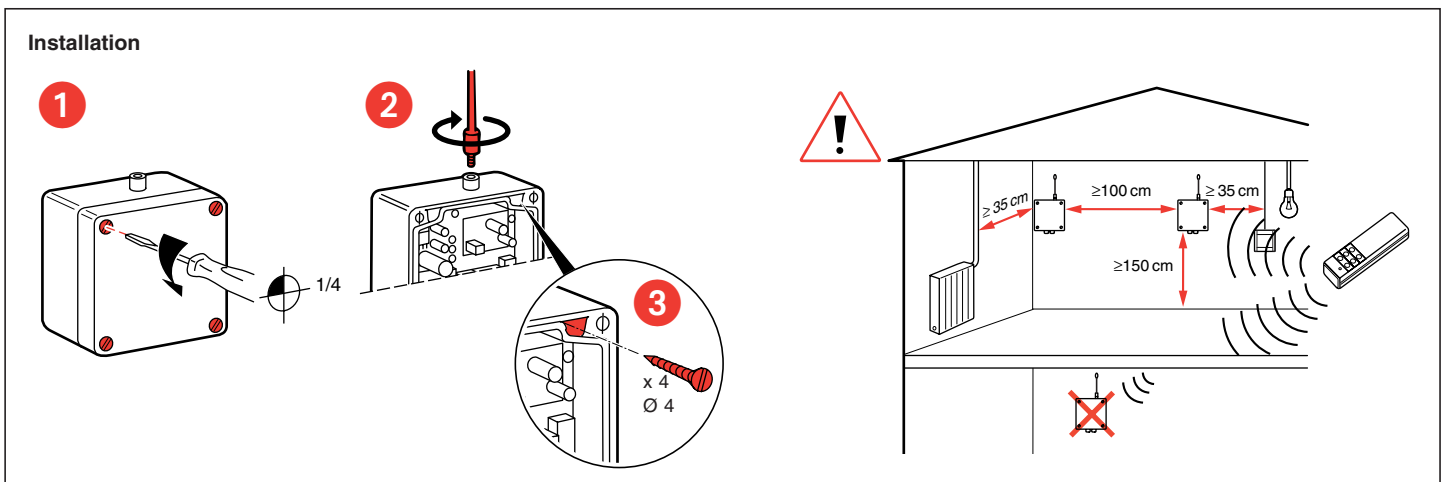

This product can store 16 different On codes and 16 different Off codes per output. It is not, however, possible to combine operating modes. Timer, Switch and Pushbutton modes will be identical for all the codes stored on one output.

Important :

When pushbutton n is pressed for more than 2 seconds the On/Off indicator flashes to indicate the change to teach mode. If the indicator flashes very quickly 3 times after pushbutton n is released, this indicates that the receiver cannot be taught any more codes. The user has two options : either to abandon teaching another transmitter, or to clear all the codes and start teaching 16 new codes. Do not exceed a period of 30 seconds between two presses on one key, otherwise the receiver will automatically exit teach mode.

Programming symbols

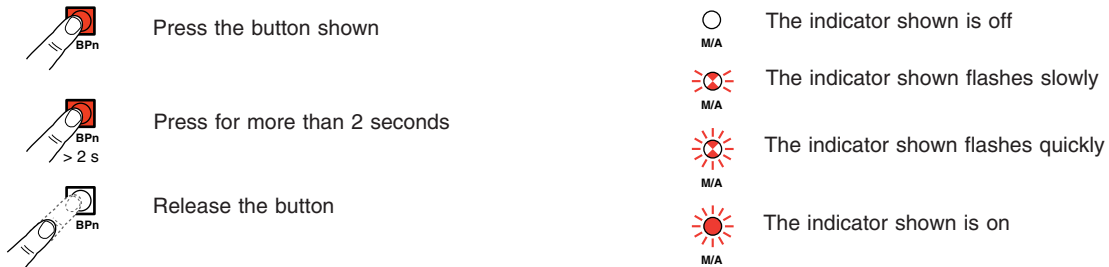

Selecting the operating mode

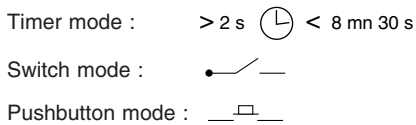

The mode can be changed by pressing pushbutton BPn repeatedly.

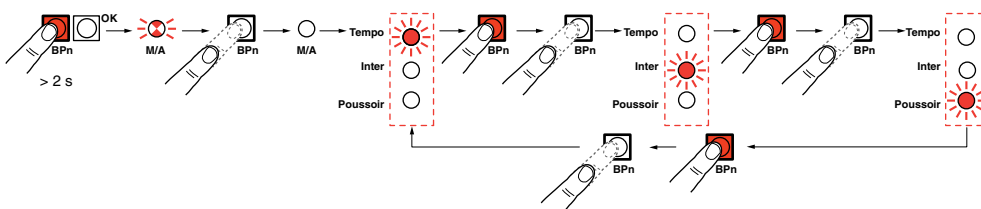

Teaching Switch mode 

Important :

It is possible to control a receiver via 2 different keys on one transmitter (use as a switch, A) or via a single key on one transmitter (use as remote switch, B). However, use as a switch is preferable if the environment is subject to interference.

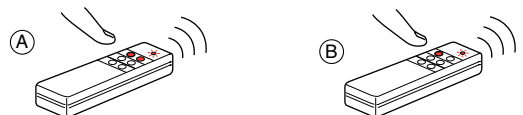

Selecting the mode

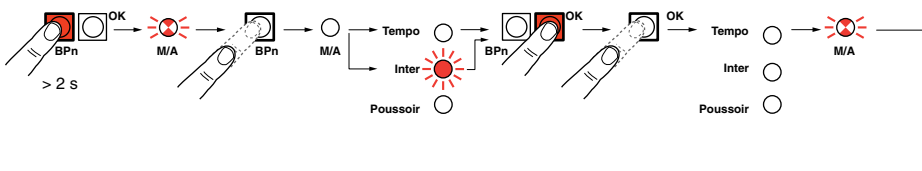

Teaching the On code

Teaching the Off code

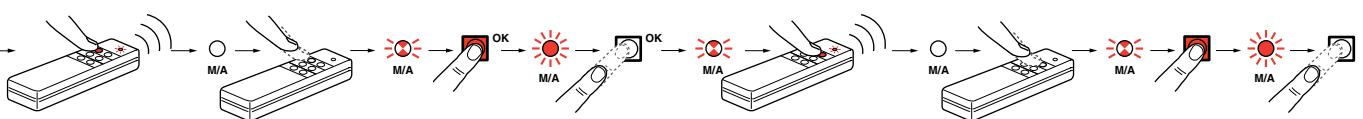

Teaching a single Off code

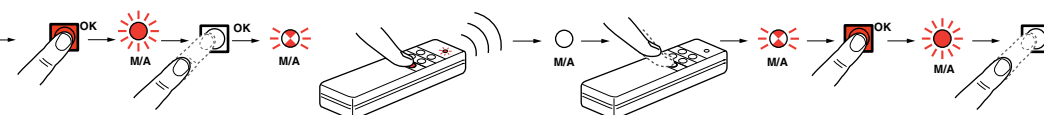

If a single Off code is taught to a number of receivers, it can be used to perform a general switch-off.

Teaching Pushbutton mode

Selecting the mode

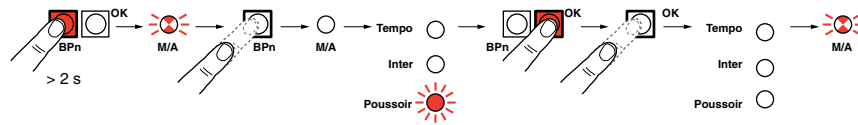

Teaching the code

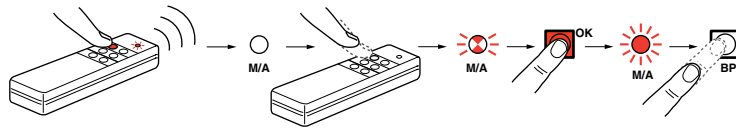

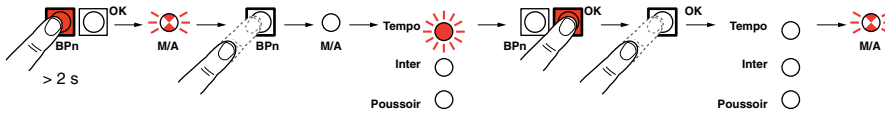

Teaching Timer mode

Selecting the mode

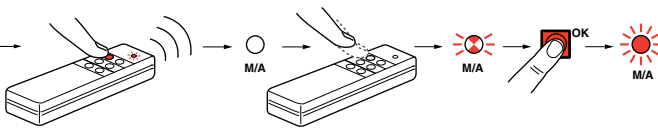

Teaching the On code





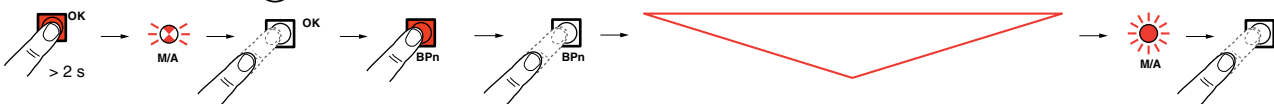

Setting the time delay (> 2 s  < 8 mn 30 s)



Note :

The On/Off indicator flashes every 4 seconds.
 Example : 1 minute = indicator comes on 15 times.
 For longer periods, use chronometer timing.
 If it is not confirmed with «OK», the time delay sets itself to 8 min 30 s.

 < 4 s > 		
x 5	20 s	OK
x 10	40 s	OK
x 15	1 mn	OK
x 30	2 mn	OK
x 60	4 mn	OK
x (X)	8 mn 30s	—

Teaching Remote Dimmer mode

Selecting the mode

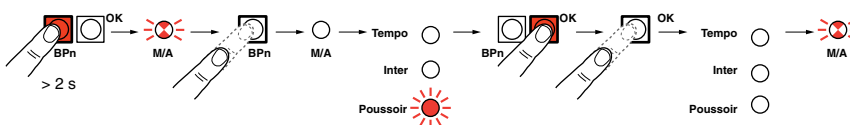

Teaching the on/dim code

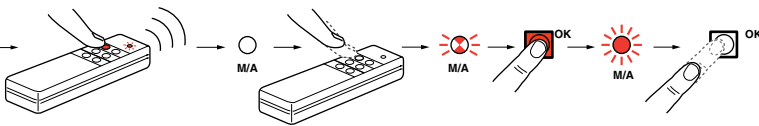

Important :
 Do not use the same remote control button for the On/dim code and the On/off code.

Teaching the on/off/ code

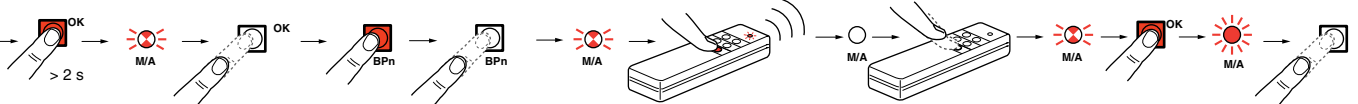

Operation

On/dim

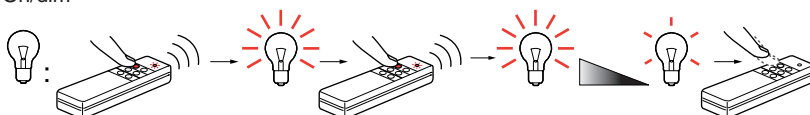

On/off

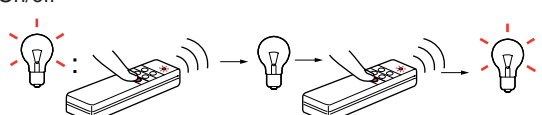

Clearing the codes

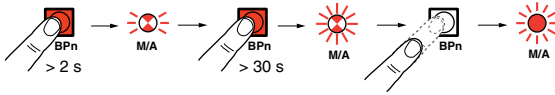

Important :

Clearing the codes results in the loss of all the codes for one output.

Operating in local mode

In switch mode : using short presses of less than 2 seconds, relais "n" closes then opens successively

In timer mode : a short press of less than 2 seconds on "BPn", relais "n" closes for the length of the time delay

In pushbutton or remote control dimmer mode a very short press of less than 0,4 seconds on "BPn", relais "n" closes for 0,4 seconds, a short press (more than 0,4 seconds but less than 2 seconds) on "BPn", relais "n" closes for about 4 seconds.

Example of wiring with remote control dimmer :

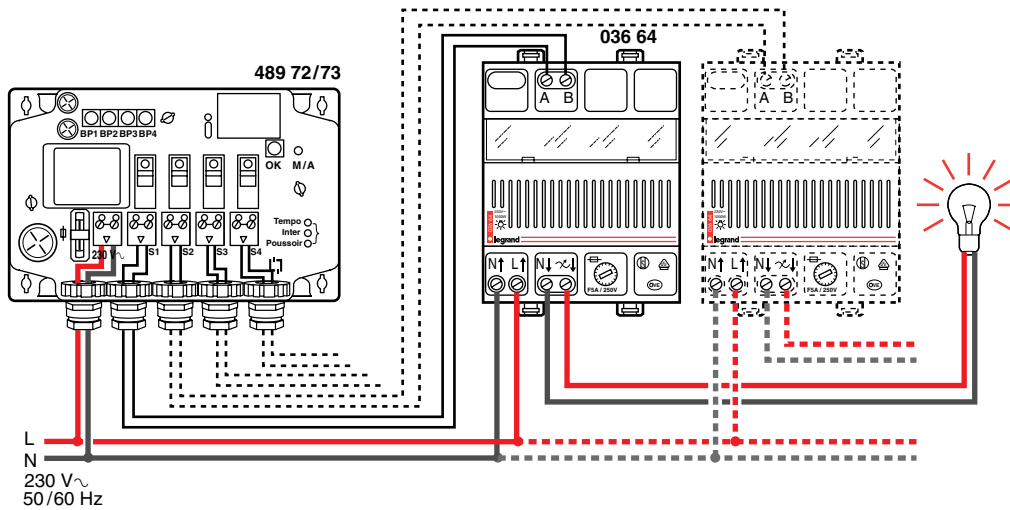
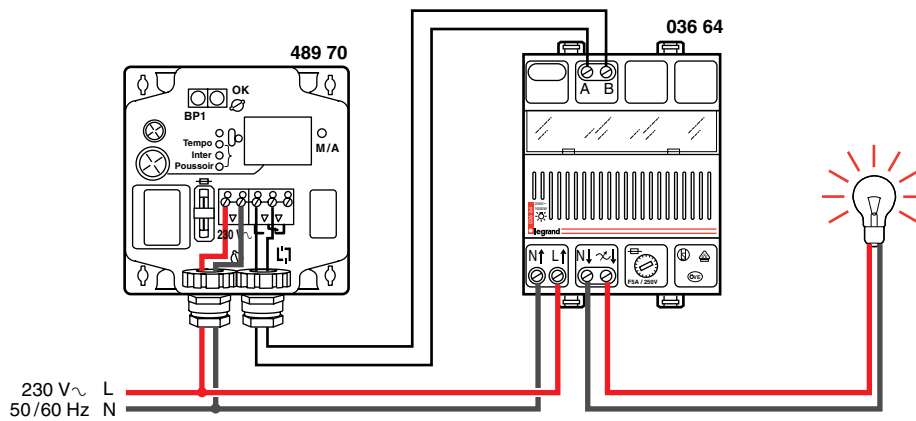

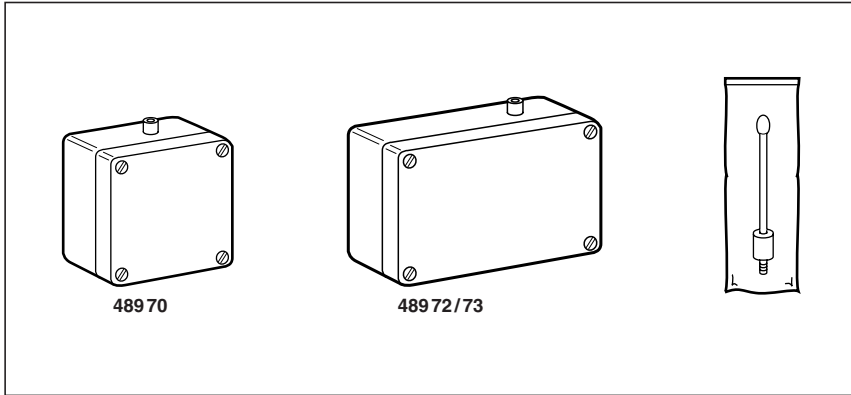

Technische Daten

U	230 V ~ - 50 / 60 Hz
F	433,92 MHz
I	14 mA
	32 mA - 250 V - 5 x 20 F
	-10 < < +55 °C

Erlaubte Last

489 70	1800 W	1800 W	1000 VA	1000 VA
489 72/73	8 A - 230 V ~	8 A - 230 V ~	1000 VA	1000 VA

Fernsteuerung

Geeignete Sender						
	489 06 489 10 489 12	489 00 489 01 489 03	882 80	841 05 841 06 841 07	746 06 746 07	916 13
	489 70 / 72 / 73					

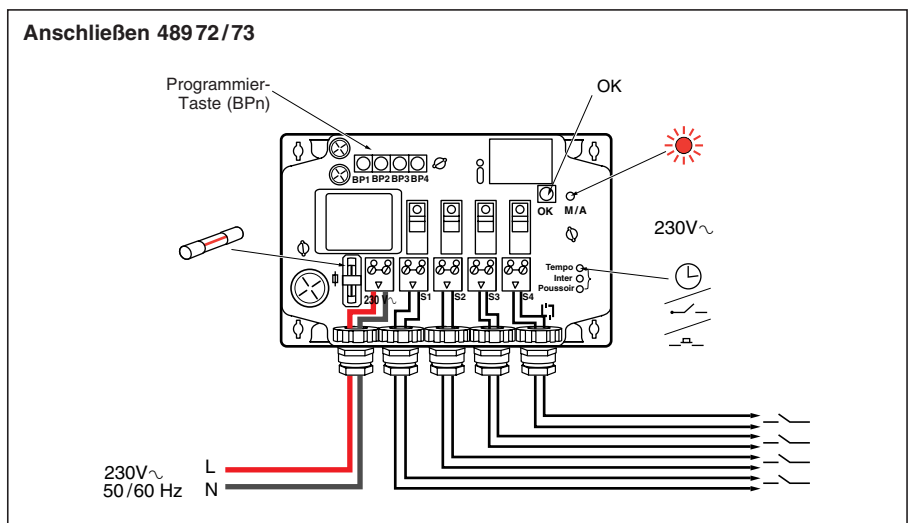
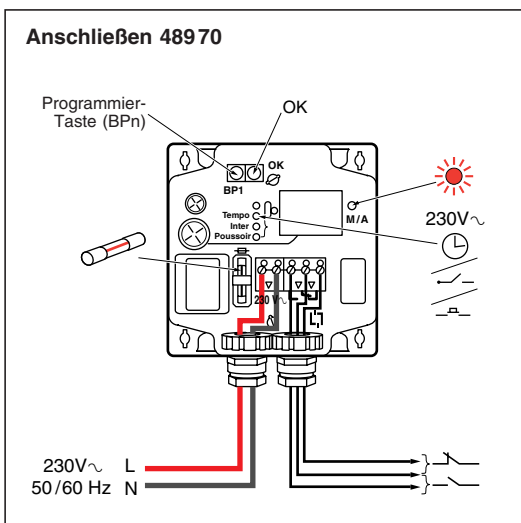
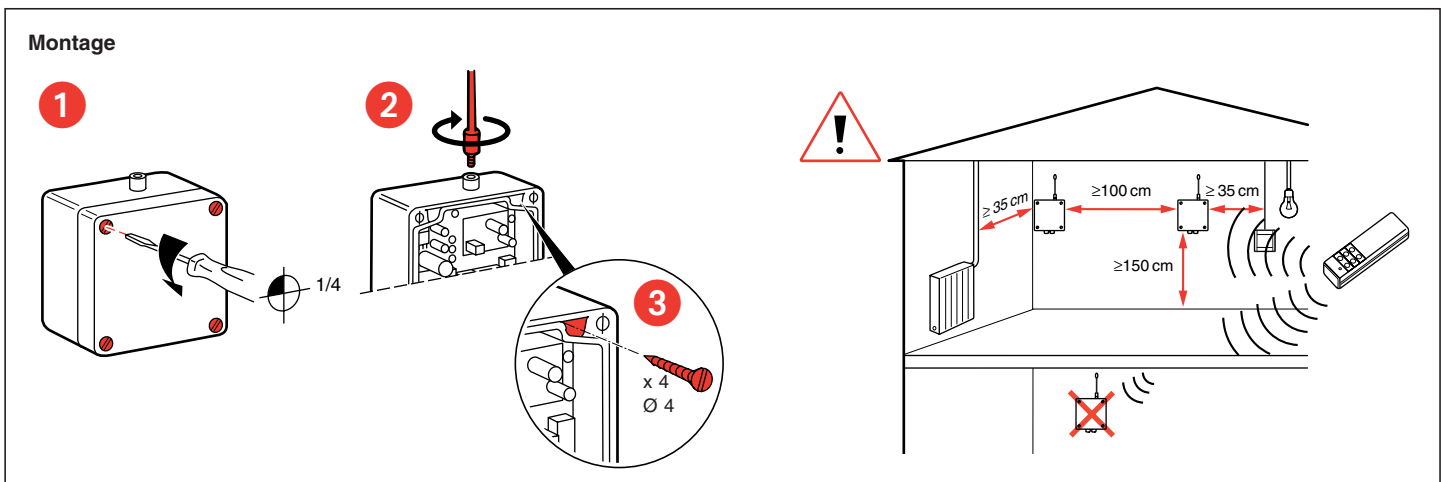

Mit diesem Gerät können Sie pro Ausgang 16 Einschaltcodes und 16 Ausschaltcodes speichern. Das Mischen der Betriebsart ist jedoch nicht möglich. Die Betriebsarten Verzögerung, Schalten oder Tasten sind jeweils für alle auf einem Ausgang gespeicherten Codes identisch.

Wichtig :

Wenn Sie länger als 2 Sekunden auf die Taste BPn drücken, blinkt die Anzeige M/A und signalisiert so den Übergang in den Lernmodus. Wenn die Anzeige 3 mal schnell hintereinander blinkt, bevor Sie die Taste BPn losgelassen haben, ist es nicht möglich, noch einen weiteren Code in den Empfänger einzugeben. Sie haben als Benutzer 2 Möglichkeiten: Sie können auf die Eingabe in einen weiteren Empfänger verzichten, oder Sie löschen alle Codes und geben 16 neue Codes ein. Wenn Sie mehr als 30 Sekunden bis zum wiederholten Drücken einer Taste verstreichen lassen, verläßt der Empfänger automatisch den Eingabemodus.

Programmierpiktogramme

	Drücken Sie die angezeigte Taste.		Die Anzeige ist erloschen.
	Halten Sie sie länger als 2 Sekunden gedrückt.		Die Anzeige blinkt in kurzen Abständen.
	Lassen Sie die Taste los.		Die Anzeige blinkt.
			Die Anzeige leuchtet.

Wahl der Betriebsart

Betriebsart Minutenschalter : $> 2s$  $< 8 \text{ min } 30 \text{ s}$

Betriebsart Schalten : 

Betriebsart Tasten : 

Der Wechsel der Betriebsart erfolgt durch mehrmaliges Drücken der Taste BPn.

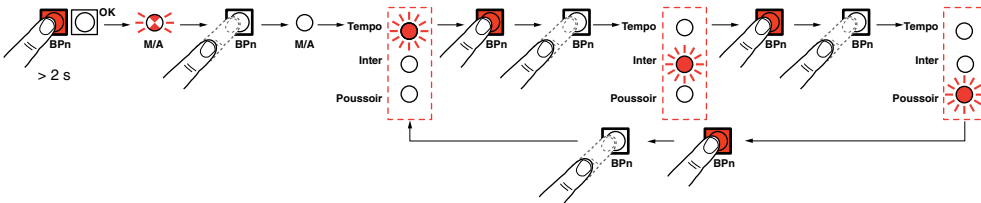

Eingeben der Betriebsart Schalten

Wichtig:

Sie können einen Empfänger mit 2 verschiedenen Tasten eines Senders (Gebrauch als Schalten A) oder mit nur einer Taste eines Senders (Gebrauch als Fernschalter B) steuern. Bei Umgebungen, in denen Störungen auftreten, empfiehlt sich allerdings der Gebrauch als Schalten.

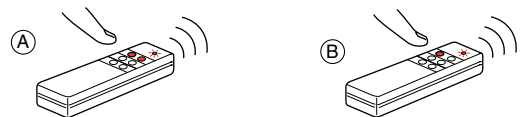

Wahl der Betriebsart

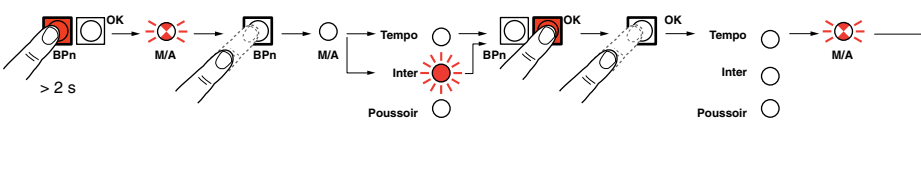

Eingabe des Betriebscodes

Eingabe des Haltecodes

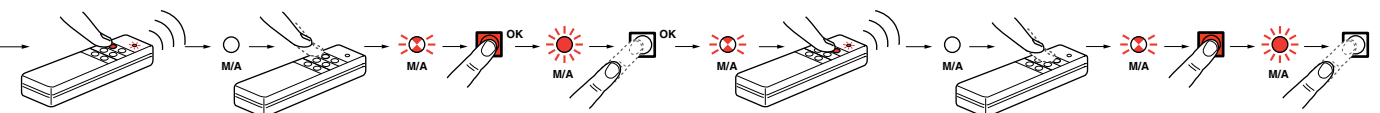

Eingabe eines einzigen Ausschaltcodes

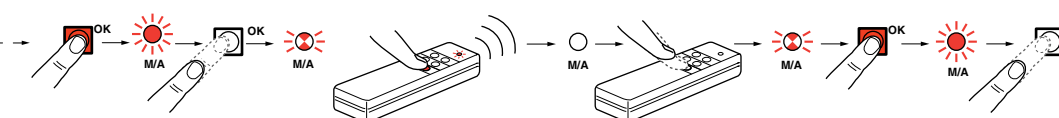

Die Einstellung eines einzigen Ausschaltcodes ermöglicht ein vollständiges Ausschalten, wenn der Code in mehrere Empfänger eingegeben wird.

Eingabe der Betriebsart Tasten

Wahl der Betriebsart

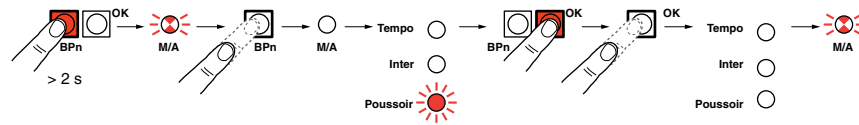

Eingabe des Codes

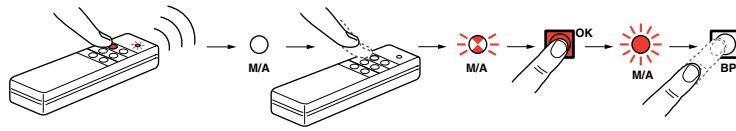

Eingabe der Betriebsart Verzögerung

Wahl der Betriebsart

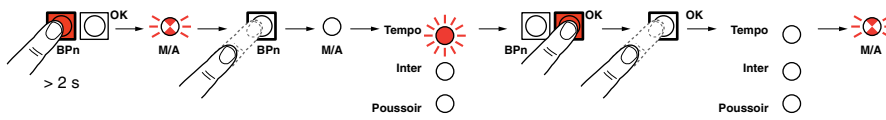

Eingabe des Betriebscodes

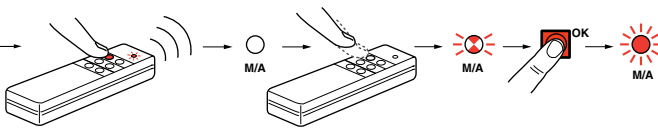



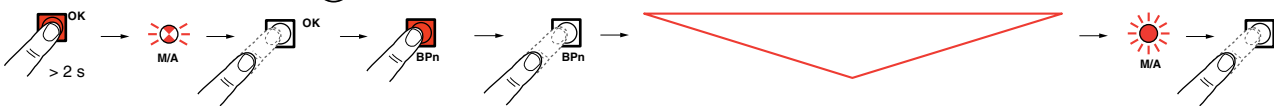

Einstellen der Verzögerung (> 2 s < 8 min 30 s)



Hinweis :

Die Anzeige M/A blinkt im Abstand von 4 Sek.
 Beispiel: 1 Minute = 15 x Aufleuchten
 Bei längerer Dauer arbeiten Sie mit Zeitmessung.
 Wenn keine Bestätigung durch «OK» erfolgt, stellt sich die Verzögerung auf 8 Minuten und 30 Sekunden ein.

 < 4 s > 		
x 5	20 s	OK
x 10	40 s	OK
x 15	1 min	OK
x 30	2 min	OK
x 60	4 min	OK
x (X)	8 min 30s	—

Eingabe der Betriebsart Fernregler

Wahl der Betriebsart

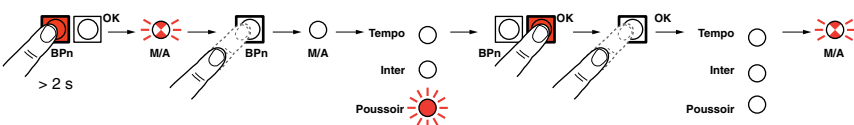

Eingabe des Betriebs-/Wechselcodes

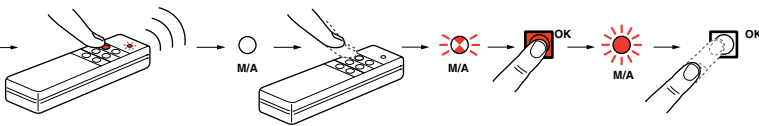

Wichtig:
 Benutzen Sie nicht dieselbe Taste der Fernbedienung für den Code Betrieb/Wechsel und den Code Betrieb/Halt.

Eingabe des Betriebs-/Haltecodes

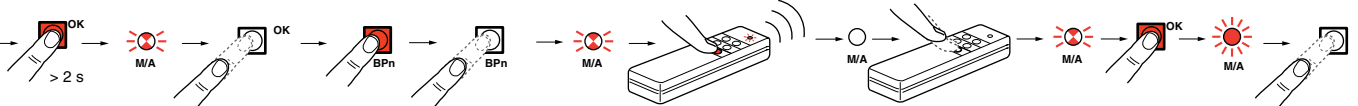

Betrieb

Betrieb / Wechsel

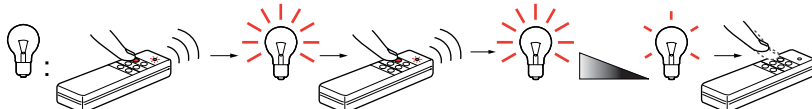

Betrieb / Halt

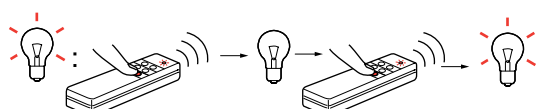

Löschen der Codes

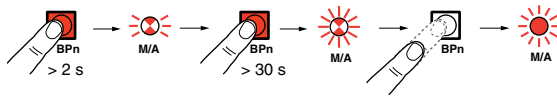

Wichtig:
Beim Löschen gehen alle Codes eines Ausgangs verloren.

Lokale Steuerung

Betriebsart Schalten : ● — durch kurzes Drücken < 2s schließt das Relais "n" und öffnet bei erneutem Schalten

Betriebsart Verzögerung : ⌚ kurzes Drücken < 2s der Taste "BPn", das Relais "n" schließt für die Dauer der Verzögerung

Betriebsart Tasten — □ — oder Fernregler : ganz kurzes Drücken < 0,4s der Taste "BPn", das Relais "n" schließt (2x) für ca. 0,4s, kurzes Drücken (> 0,4s, < 2s) der Taste "BPn", das Relais "n" schließt (2x) für ca. 4s.

Beispiel für Verkabelung mit einem Fernregler :

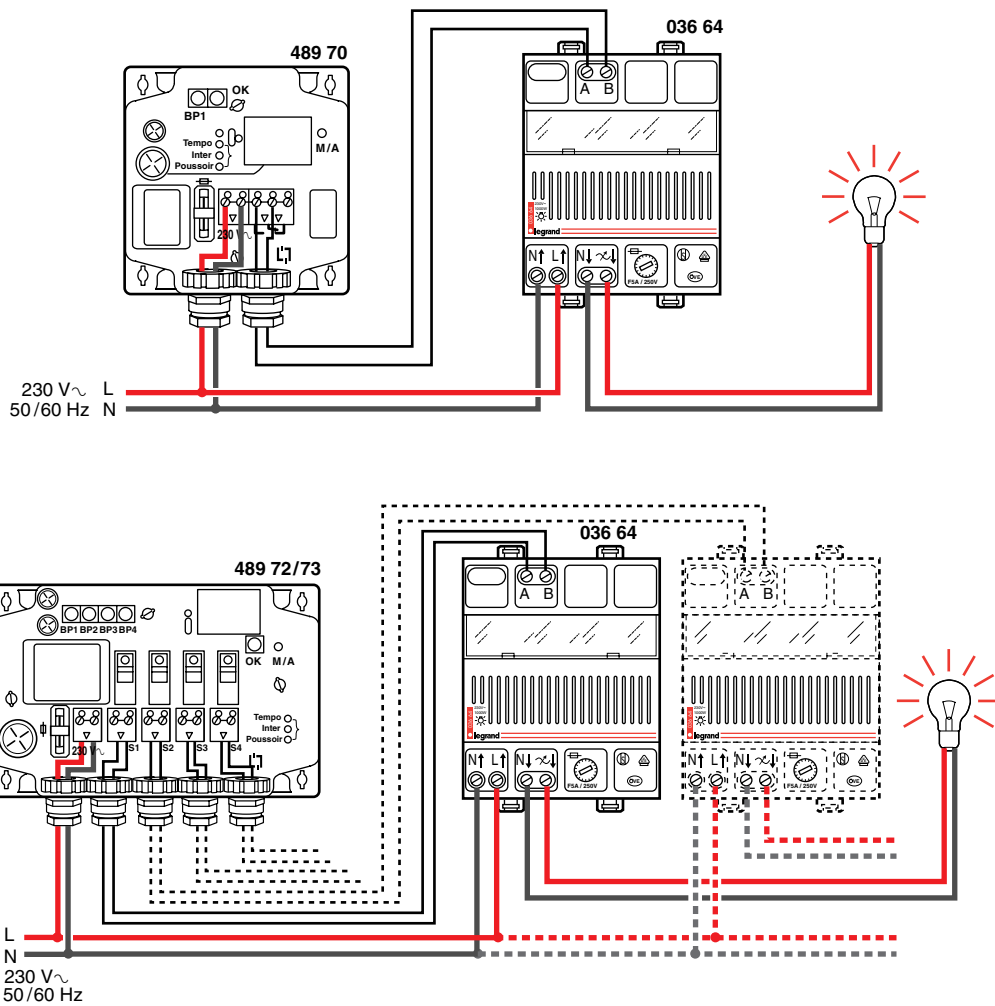

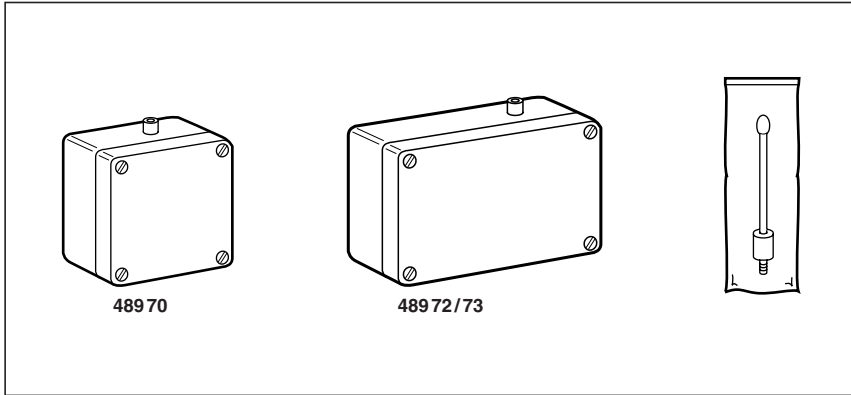

Características técnicas

U	230 V ~ - 50 / 60 Hz
F	433,92 MHz
I	14 mA
	32 mA - 250 V - 5 x 20 F
	-10 < < +55 °C

Utilización

489 70	1800 W	1800 W	1000 VA	1000 VA
489 72/73	8 A - 230 V ~	8 A - 230 V ~	1000 VA	1000 VA

Funcionamiento a distancia

emisores						
	489 06 489 10 489 12	489 00 489 01 489 03	882 80	841 05 841 06 841 07	746 06 746 07	916 13
	489 70 / 72 / 73					

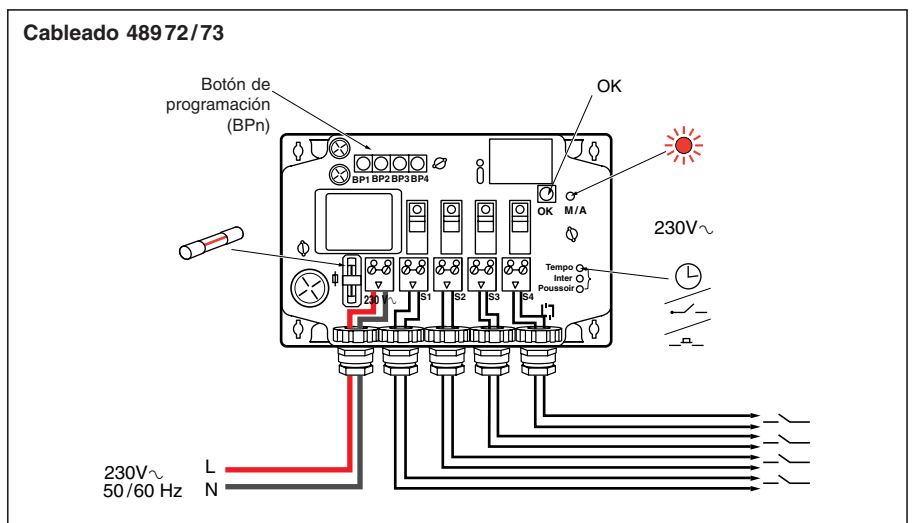
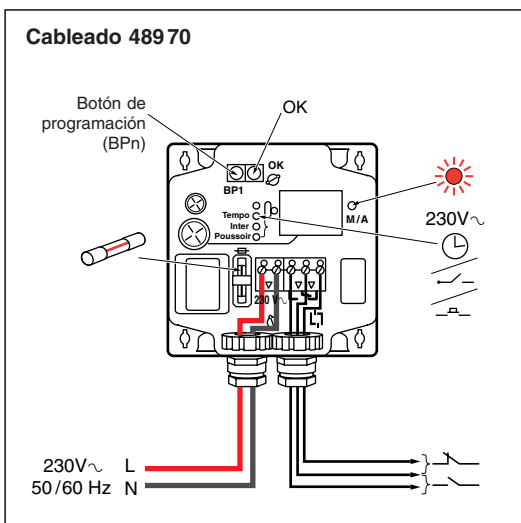
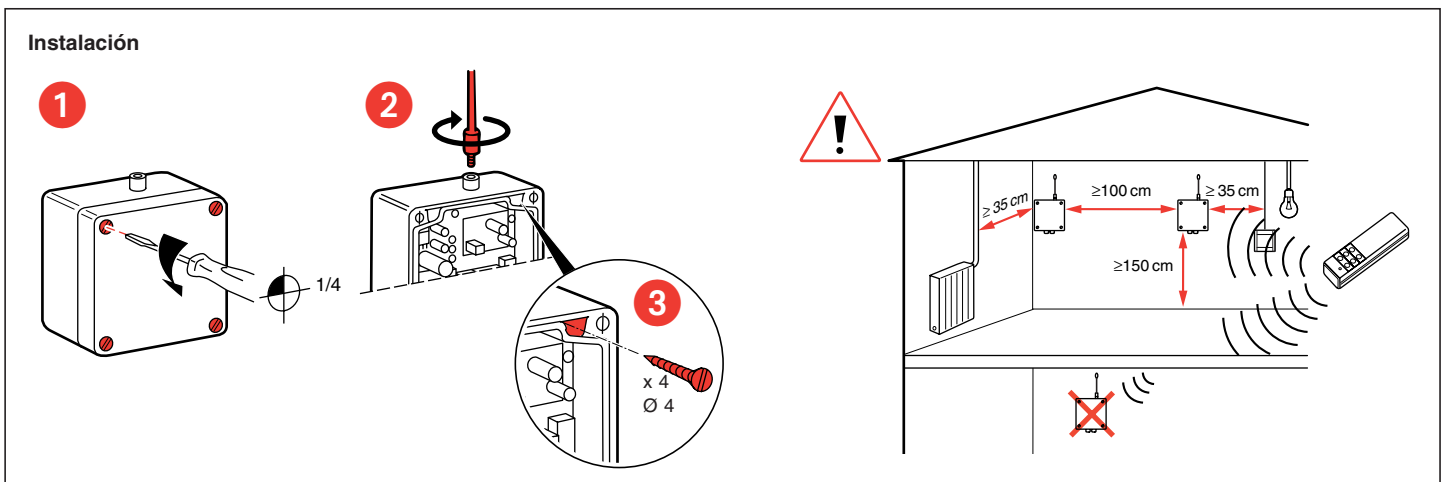







Este producto puede memorizar 16 códigos de Encendido y 16 de Apagado distintos por salida. No obstante, no es posible mezclar los modos de funcionamiento. El modo de funcionamiento, Temporización, Interruptor o Pulsador, será idéntico para todos los códigos memorizados en una misma salida.

Importante :

Tras pulsar el botón BPn durante más de 2 segundos, el piloto M/A parpadea para indicar el paso al modo de codificación. Si el piloto parpadea muy rápidamente 3 veces después de soltar el botón BPn, indica que el receptor no tiene capacidad para codificar un código adicional. En este caso, el usuario tiene 2 opciones: renunciar a la codificación de un emisor adicional o borrar todos los códigos y codificar 16 códigos nuevos. El tiempo entre dos pulsaciones de una misma tecla no debe ser superior a 30 segundos, ya que el receptor sale automáticamente del modo de codificación.

Pictogramas de programación

	Pulse el botón indicado		El piloto indicado está apagado
	Pulse durante más de 2 segundos		El piloto indicado parpadea
	Suelte el botón		El piloto indicado emite un «flash»
			El piloto indicado está encendido

Selección del modo de funcionamiento

Modo temporización: > 2 s ⌚ < 8 min 30 s

Modo interruptor: 

Modo pulsador: 

Para cambiar de modo, pulse varias veces la tecla BPn.

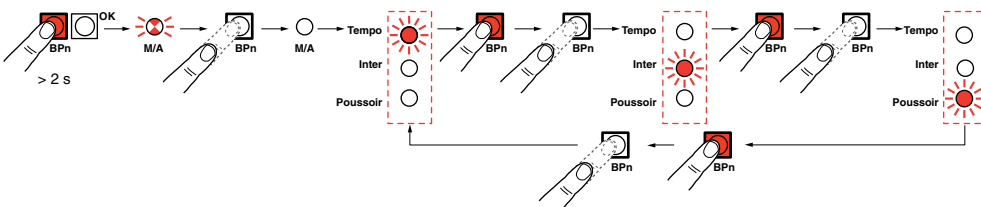

Codificación del modo Interruptor 

Importante :

Es posible controlar un receptor por medio de 2 teclas distintas de un emisor (modo interruptor A) o por medio de una sola tecla de un emisor (modo teleinterruptor B). No obstante, el modo interruptor es preferible en caso de interferencias.

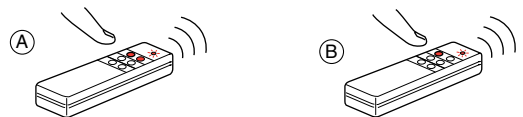

Selección del modo

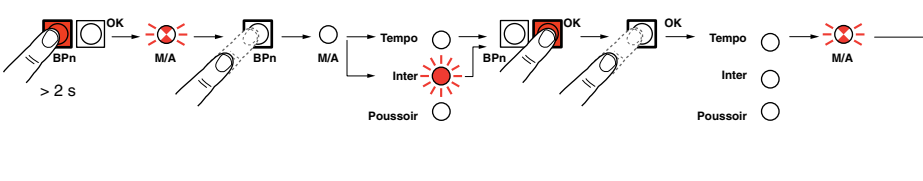

Codificación del código de marcha

Codificación del código de parada

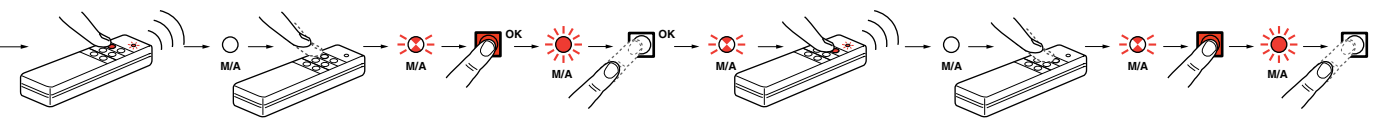

Codificación de un código de apagado único

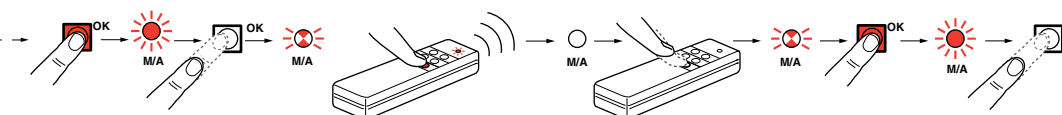

Es posible que varios receptores se codifique con un mismo código de apagado para realizar un apagado general.

Codificación del modo Pulsador

Selección del modo

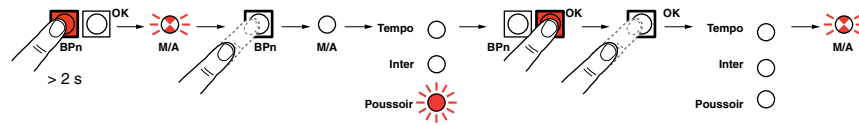

Codificación del código

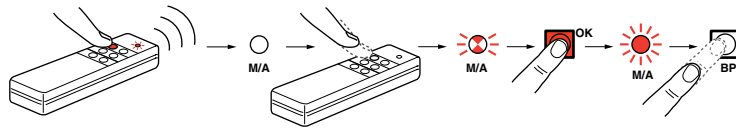

Codificación del modo Temporización

Selección del modo

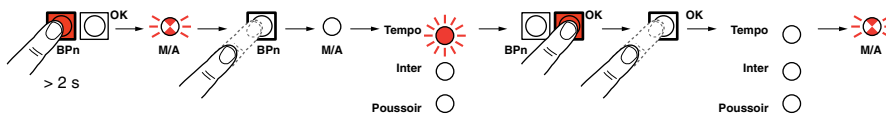

Codificación del código de marcha

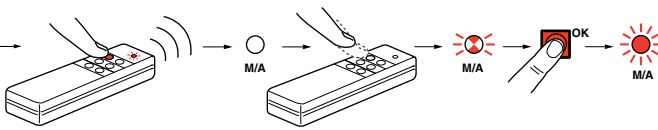



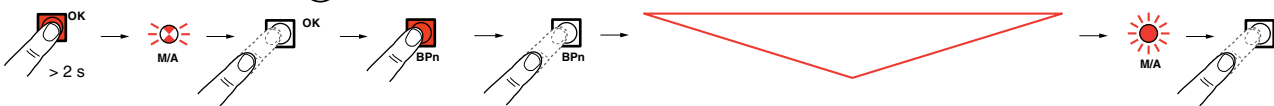

Ajuste de la temporización (> 2 s < 8 min 30 s)



Nota :

El piloto M/A parpadea cada 4 s.
Ejemplo: 1 minuto = 15 encendidos.
En caso de mayor duración, utilice un cronómetro.
Si no se valida por medio de «OK», la temporización se ajusta a 8 m y 30 s.

 < 4 s > 		
x 5	20 s	OK
x 10	40 s	OK
x 15	1 min	OK
x 30	2 min	OK
x 60	4 min	OK
x (X)	8 min 30s	—

Codificación del modo Regulador

Selección del modo

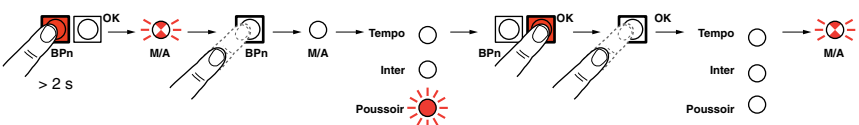

Codificación del código de marcha/regulación

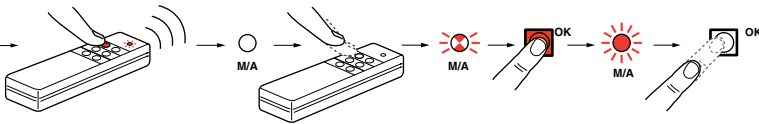

Importante :

No utilice la misma tecla de mando a distancia para el código de marcha/regulación y el código de marcha/parada.

Codificación del código de marcha/parada

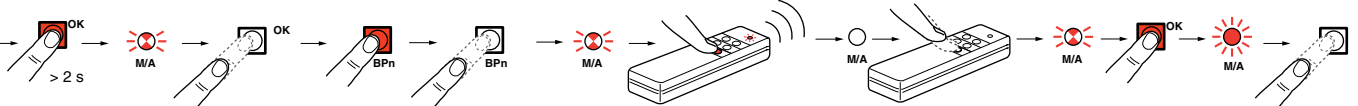

Funcionamiento

Marcha/regulación

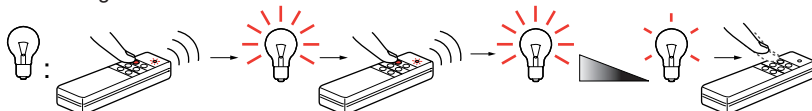

Marcha/parada

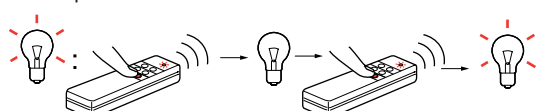

Borrado de los códigos

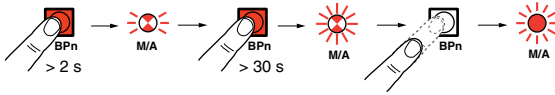

Importante :

El borrado provoca la pérdida de todos los códigos de una salida.

Funcionamiento en modo local

En modo interruptor : mediante breves pulsaciones de < 2s, el relé "n" se cierra y se abre sucesivamente

En modo temporización : pulsando brevemente durante < 2s en "BPn", el relé "n" se cierra en el tiempo especificado

En modo pulsador o regulador de luz : pulsando brevemente durante < 0,4s en "BPn", el relé "n" se cierra durante 0,4s, y pulsando brevemente (> 0,4s, < 2s) en "BPn", el relé "n" se cierra durante aproximadamente 4s.

Ejemplo de cableado con regulador de luz :

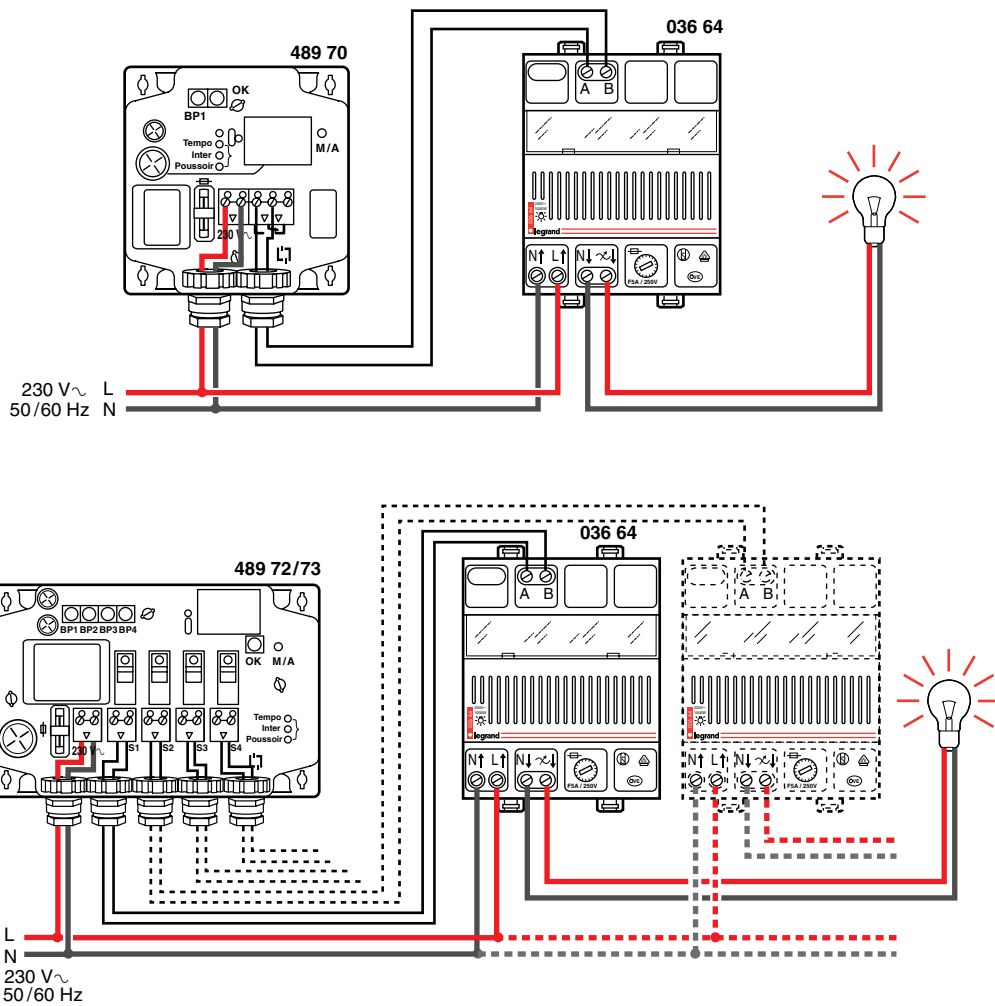

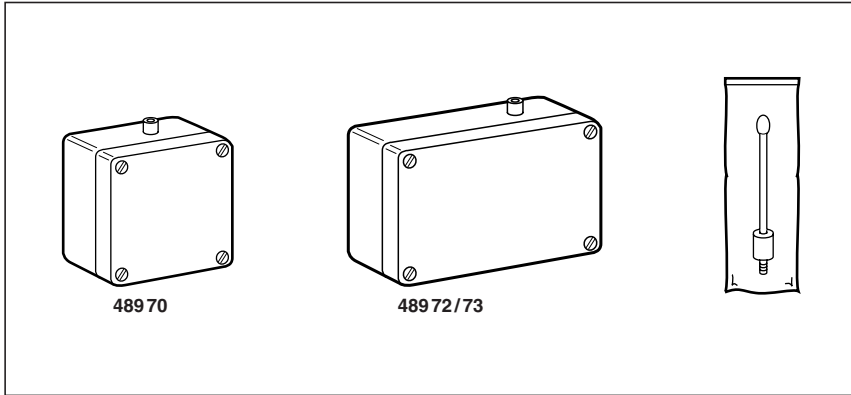

Características técnicas

U	230 V ~ - 50 / 60 Hz
F	433,92 MHz
I	14 mA
	32 mA - 250 V - 5 x 20 F
	-10 < < +55 °C

Utilização

489 70	1800 W	1800 W		
489 72/73	8 A - 230 V ~	8 A - 230 V ~	1000 VA	

Comando à distância

Emissores compatíveis						
	489 06 489 10 489 12	489 00 489 01 489 03	882 80	841 05 841 06 841 07	746 06 746 07	916 13
	489 70 / 72 / 73					

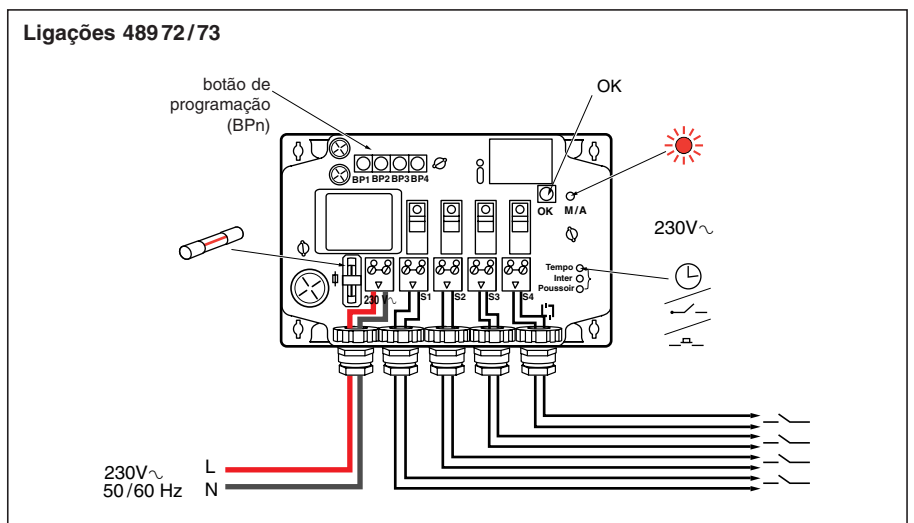
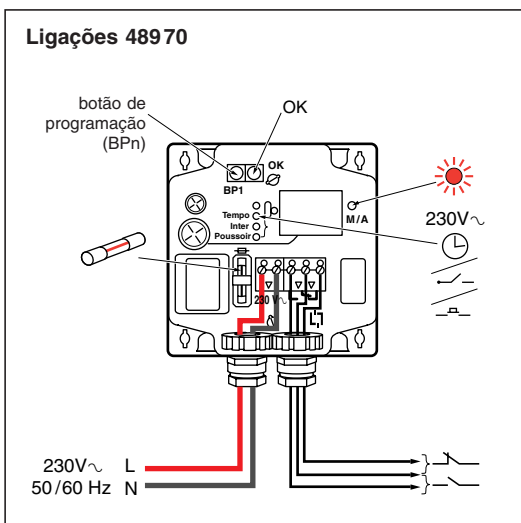
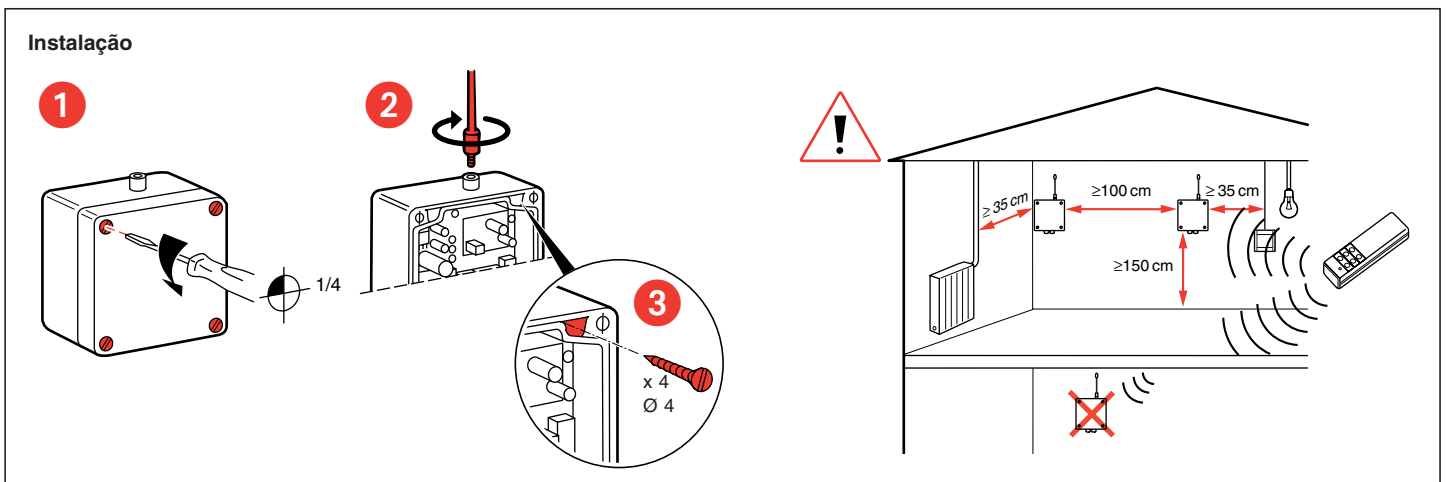

Este produto pode memorizar 16 códigos para Ligar e 16 códigos para Desligar diferentes por saída. No entanto, não é possível misturar modos de funcionamento. O modo de funcionamento Temporização, Interruptor ou Botão será idêntico para todos os códigos memorizados numa saída.

Atenção:

Após premir o botão de programação (BPn) durante mais de 2 segundos, o indicador M/A fica intermitente para assinalar a passagem ao modo de programação. Se o indicador piscar muito rapidamente 3 vezes, depois de ter libertado o botão BPn, isto significa que já não é possível memorizar um código suplementar no receptor. Colocam-se 2 possibilidades ao utilizador: desistir da memorização de um emissor suplementar, ou apagar todos os códigos e proceder à memorização de 16 novos códigos.

Não ultrapassar um prazo de 30 segundos entre duas pressões consecutivas de uma tecla, caso contrário o receptor sai automaticamente do modo de programação.

Símbolos de programação

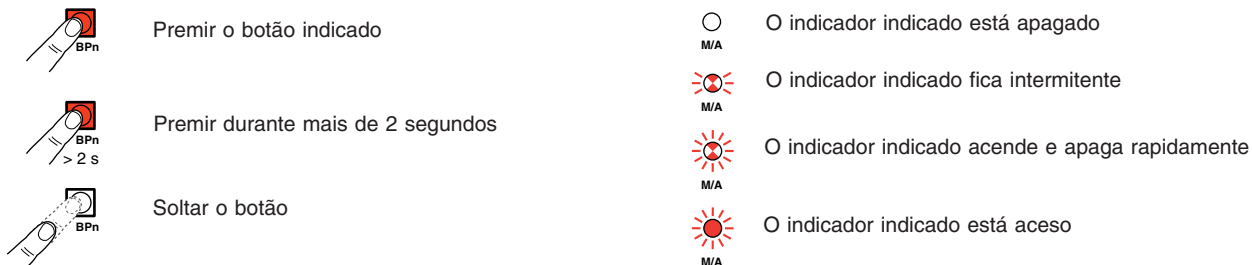

Escolha do modo de funcionamento

Modo temporizador : > 2 seg. ⌚ < 8 min 30 seg.

Modo interruptor :

Modo botão :

A alteração de modo é obtida através de pressões sucessivas da tecla BPn.

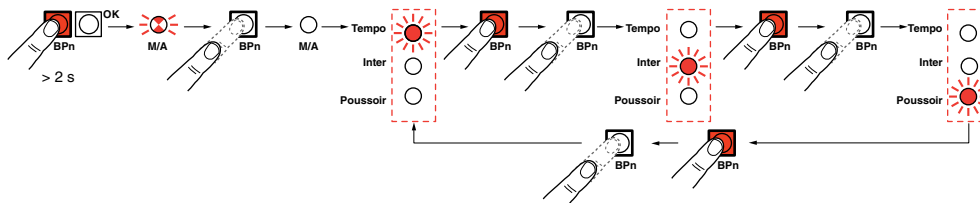

Programação do modo interruptor

Atenção:

É possível controlar um receptor através de 2 teclas diferentes de um emissor (utilização como interruptor A) ou através de uma única tecla de um emissor (utilização como interruptor à distância B). No entanto, é preferível a utilização como interruptor se o ambiente for perturbado.



Seleção do modo

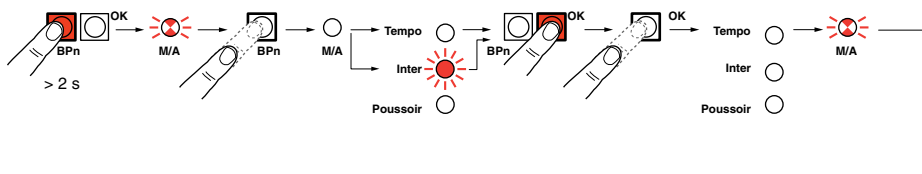

Memorização do código de arranque

Memorização do código de paragem



Memorização de um único código para desligar

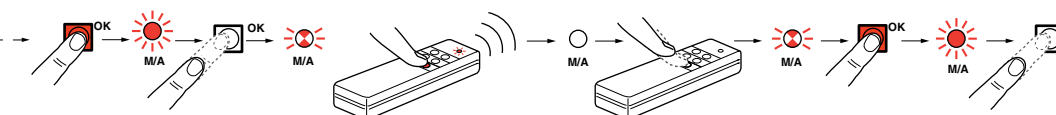

A memorização de um único código para desligar, permite, se este código for memorizado em vários receptores, obter um corte geral.

Programação do modo Botão (contacto NA)

Seleção do modo

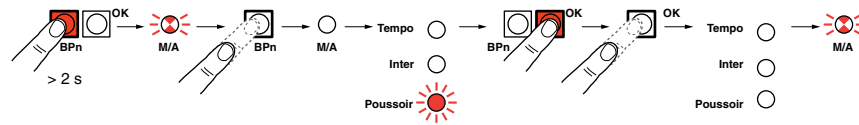

Memorização do código

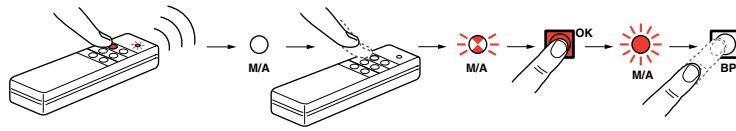

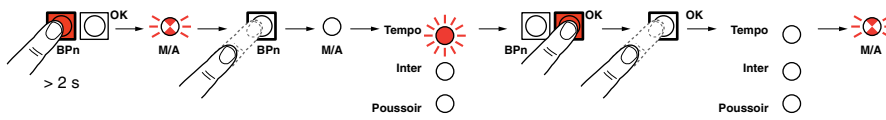

Programação do modo Temporização

Seleção do modo

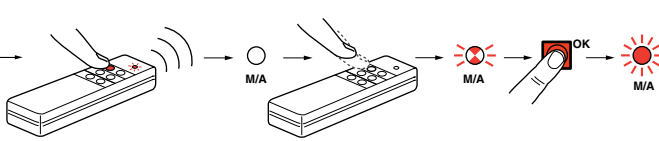

Memorização do código de arranque





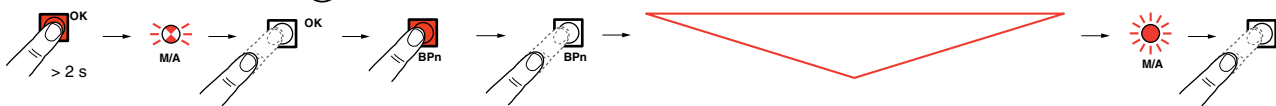

Ajuste da temporização (> 2 seg.  < 8 min 30 seg.)



Nota :

O indicador M/A pisca de 4 em 4 segundos.
Exemplo: 1 minuto = 15 acendimentos.
Para tempos superiores, cronometrar.
Se a validação em «OK» não for realizada, a temporização regula-se para 8 minutos e 30 segundos.

 < 4 seg. > 		 OK
x 5	20 seg.	OK
x 10	40 seg.	OK
x 15	1 min	OK
x 30	2 min	OK
x 60	4 min	OK
x (X)	8 min 30 seg.	—

Programação do modo Televariador

Seleção do modo

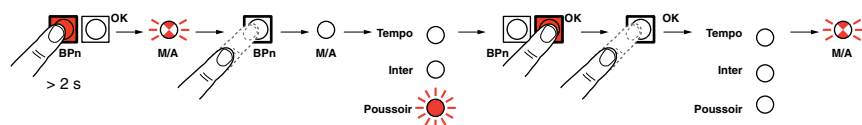

Memorização do código de arranque/variação

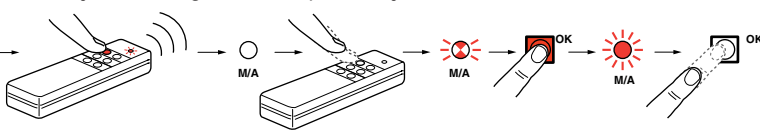

Atenção:
Não utilizar a mesma tecla do comando à distância para o código de arranque/variação e para o código de arranque/paragem.

Memorização do código de arranque/paragem

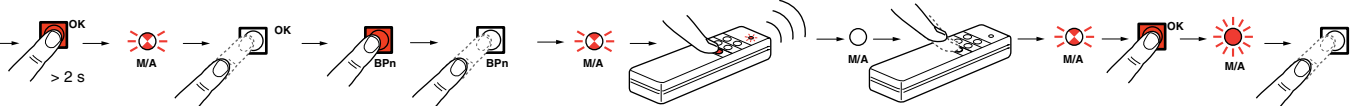

Funcionamento

Arranque/variação

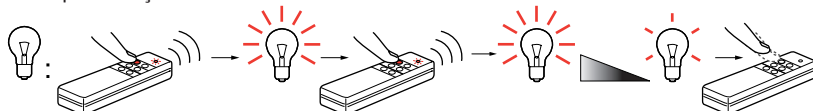

Arranque/paragem

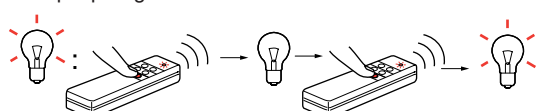

Apagar códigos

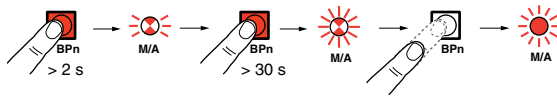

Atenção:

A eliminação provoca a perda de todos os códigos de uma saída.

Funcionamento no modo local

No modo interruptor : — / — através de breves pressões < 2 seg., o relé “n” fecha-se e abre-se sucessivamente

No modo temporização : ⌚ a uma breve pressão < 2 seg. no botão BPn, o relé “n” fecha-se durante o período de temporização

No modo botão — □ — ou televariador a uma pressão muito breve < 0,4 seg. no botão BPn, o relé “n” fecha-se durante 0,4 seg., uma pressão breve (> 0,4 seg., < 2 seg.) no botão BPn, o relé “n” fecha-se durante cerca de 4 seg.

Exemplo de ligações com televariador :

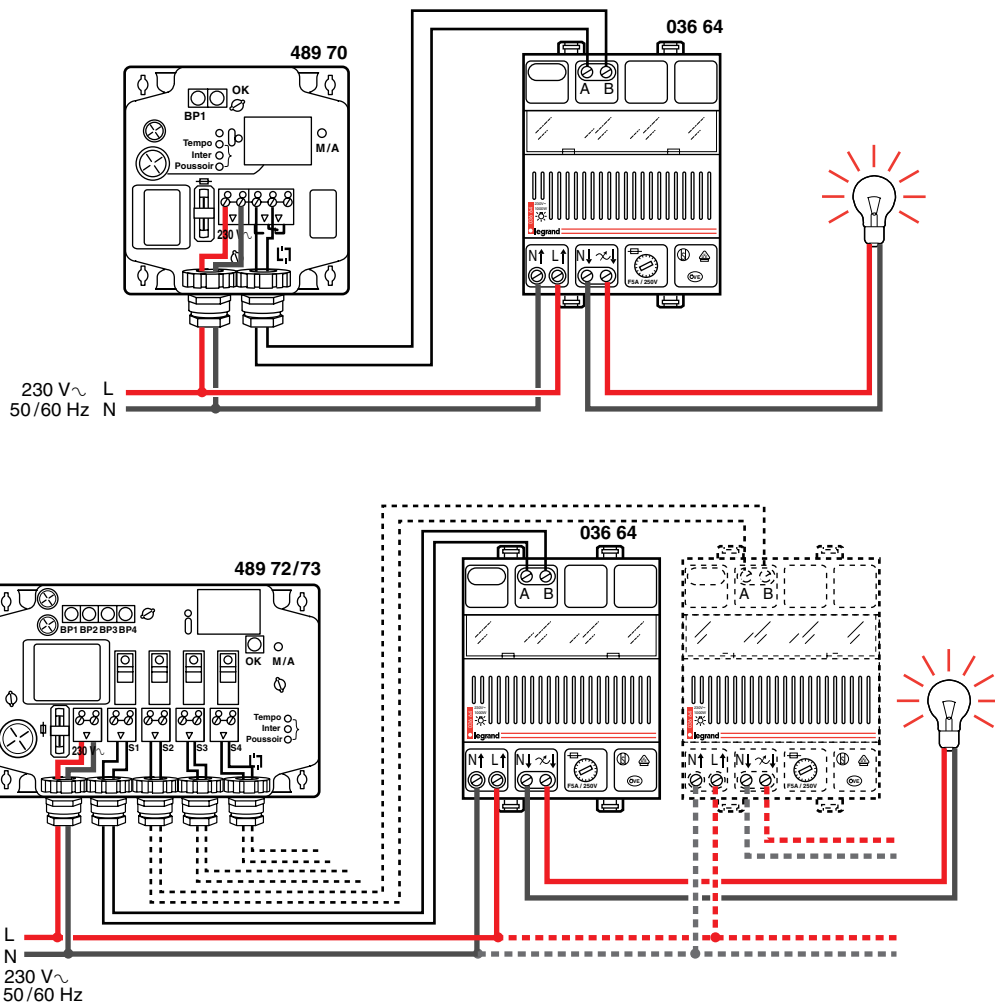

Plexo 55

Ασύρματος δέκτης CAD
489 70/72/73

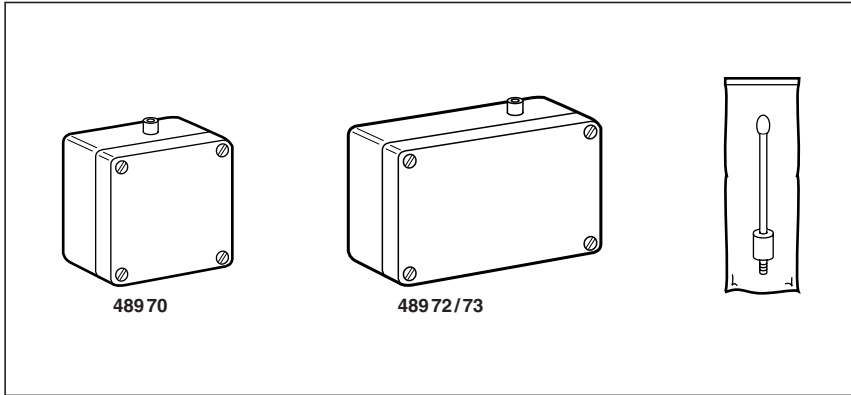

Τεχνικά χαρακτηριστικά

U	230 V ~ - 50 / 60 Hz
F	433,92 MHz
I	14 mA
	32 mA - 250 V - 5 x 20 F
	-10 < < +55 °C

Εφαρμογές

489 70	1800 W	1800 W	1000 VA	LED
489 72/73	8 A - 230 V ~	8 A - 230 V ~	1000 VA	LED

Λειτουργία από απόσταση

Συνεργαζόμενοι πομποί						
	489 06 489 10 489 12	489 00 489 01 489 03	882 80	841 05 841 06 841 07	746 06 746 07	916 13
	489 70 / 72 / 73					

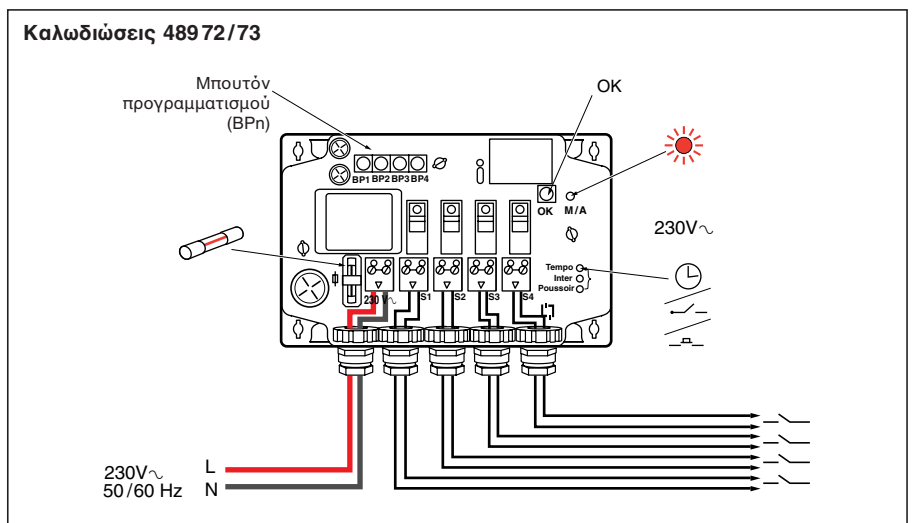
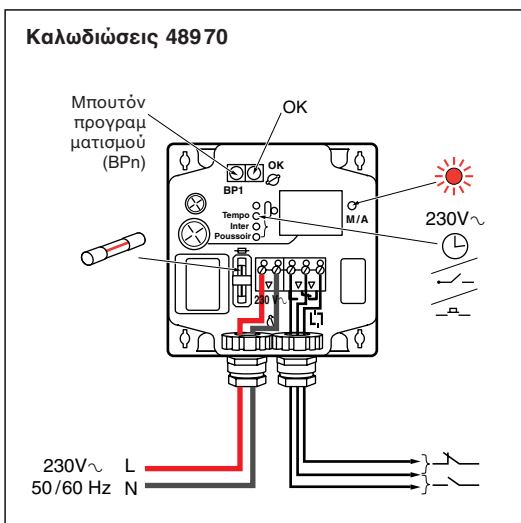
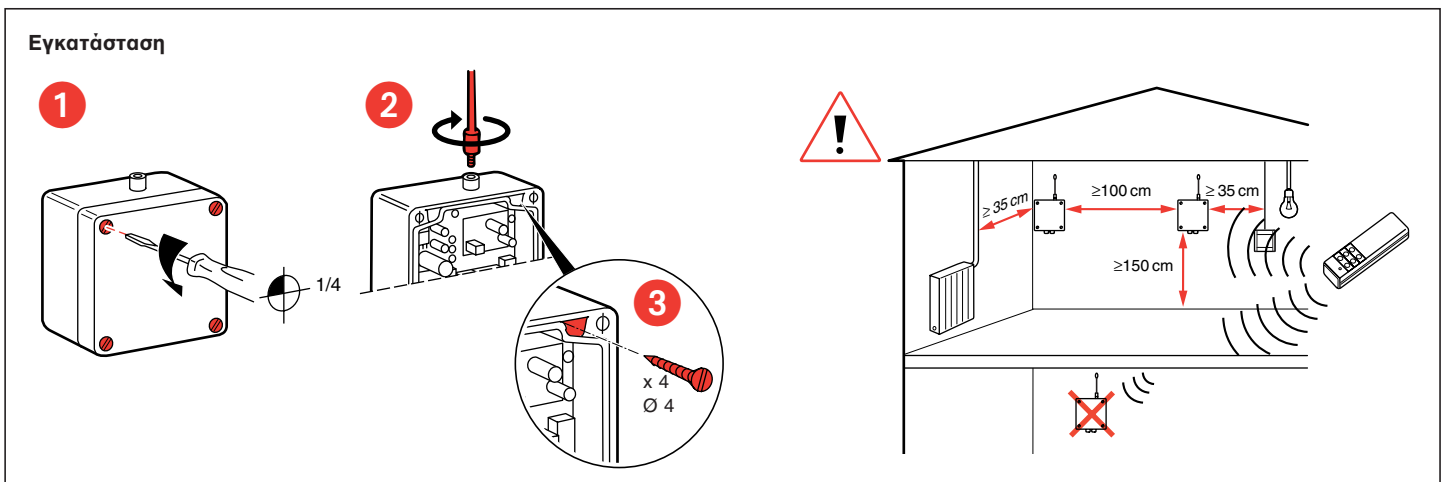







Αυτό το προϊόν μπορεί να απομνημονεύσει 16 διαφορετικούς κωδικούς έναυσης και 16 διαφορετικούς κωδικούς σβέσης ανά έξοδο. Ωστόσο δεν είναι δυνατό να συνδυαστούν οι διάφοροι τρόποι λειτουργίας. Η επιλογή του τρόπου λειτουργίας ως χρονοδιακόπτη, διακόπτη ή πιεζοδιακόπτη θα είναι η ίδια για όλους τους απομνημονευμένους κωδικούς στην ίδια έξοδο.

Σημαντικό:

Μετά από ένα πάτημα στο BPn > 2 δευτερόλεπτα, η ένδειξη M/A αναβοσβήνει επισημαίνοντας το πέρασμα στη λειτουργία προγραμματισμού. Στη περίπτωση που η ένδειξη αναβοσβήσει πολύ γρήγορα για 3 φορές, αφού έχετε αφήσει το πλήκτρο BPn, αυτό σημαίνει ότι δεν είναι πλέον δυνατός ο προγραμματισμός σε έναν άλλο κωδικό του δέκτη. Ο χειριστής έχει 2 δυνατότητες: είτε να εγκαταλείψει τη διαδικασία προχωρώντας στον προγραμματισμό του επόμενου δέκτη είτε να διαγράψει όλους τους κωδικούς και να προχωρήσει στον προγραμματισμό 16 νέων κωδικών. Μην υπερβαίνετε τα 30 δευτερόλεπτα μεταξύ δύο πατημάτων ενός πλήκτρου, διαφορετικά ο δέκτης θα διακόψει αυτομάτως την διαδικασία προγραμματισμού.

Εικονοσύμβολα προγραμματισμού

	Πατήστε το πλήκτρο που επισημαίνεται		Η ένδειξη που επισημαίνεται είναι σβηστή
	Κρατήστε το πατημένο περισσότερο από 2 δευτερόλεπτα		Η ένδειξη που επισημαίνεται αναβοσβήνει αργά
	Αφήστε το πλήκτρο		Η ένδειξη που επισημαίνεται αναβοσβήνει γρήγορα
			Η ένδειξη που επισημαίνεται είναι αναμμένη

Επιλογή του τρόπου λειτουργίας

Λειτουργία χρονοδιακόπτη : > 2 δευτ.  < 8 λεπτ· 30 δευτ.

Λειτουργία διακόπτη : 

Λειτουργία πιεζοδιακόπτη : 

Η αλλαγή λειτουργίας γίνεται με διαδοχικά πατήματα του πλήκτρου BPn.

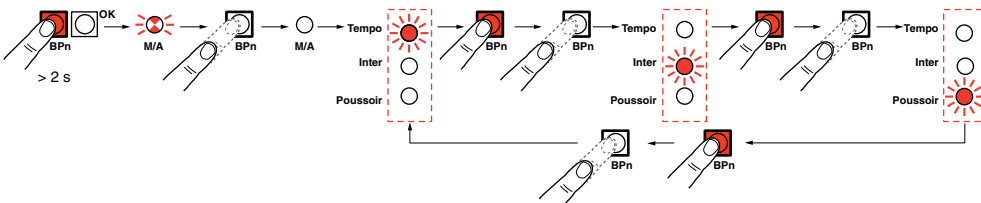

Προγραμματισμός για λειτουργίας διακόπτη 

Σημαντικό:

Είναι δυνατός ο έλεγχος ενός δέκτη από 2 διαφορετικά πλήκτρα ενός πομπού (χρήση ως διακόπτη, A) ή με ένα μόνο πλήκτρο ενός πομπού (χρήση ως τηλεδιακόπτη, B). Ωστόσο, η χρήση ως διακόπτη είναι προτιμότερη στη περίπτωση που υπάρχουν διαταραχές (παράσιτα) στο περιβάλλον.



Επιλογή λειτουργίας

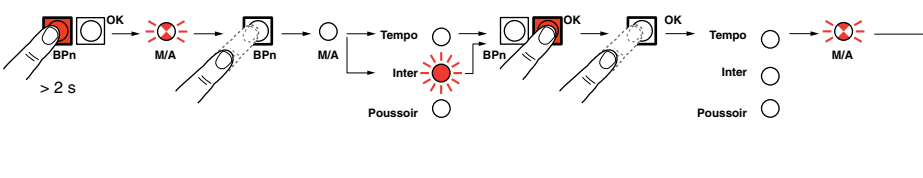

Προγραμματισμός κωδικού εκκίνησης

Προγραμματισμός κωδικού σβησίματος



Προγραμματισμός ενός μοναδικού κωδικού σβησίματος



Με τον προγραμματισμό ενός μοναδικού κωδικού σβησίματος είναι δυνατό να πραγματοποιήσουμε ένα γενικό σβήσιμο εφόσον αυτός ο κωδικός έχει προγραμματιστεί και στους υπόλοιπους δέκτες.

Προγραμματισμός για λειτουργία πιεζοδιακόπτη

Επιλογή λειτουργίας

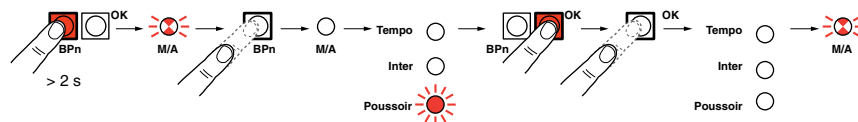

Προγραμματισμός κωδικού

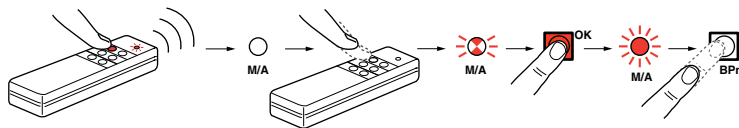

Προγραμματισμός για λειτουργία χρονοδιακόπτη

Επιλογή λειτουργίας

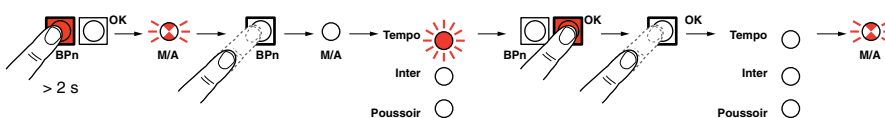

Προγραμματισμός κωδικού εκκίνησης

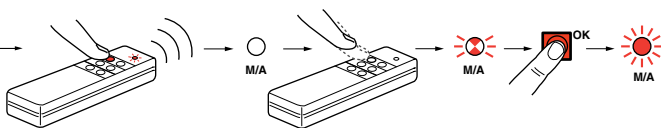

Ρύθμιση της χρονικής καθυστέρησης (> 2 δευτ. < 8 λεπτά 30 δευτ.)

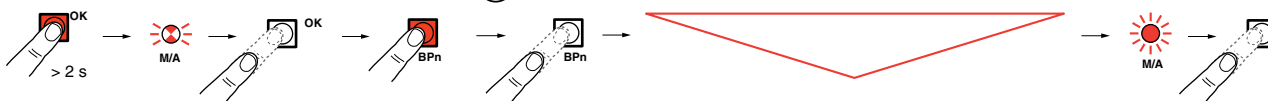

Σημείωση:

Η ένδειξη M/A αναβοσβήνει κάθε 4 δευτερόλεπτα.
 Παράδειγμα: 1 λεπτό = 15 αναβοσβήσεις.
 Για μεγαλύτερες χρονικές διάρκειες, χρησιμοποιήστε διαδικασία χρονομέτρησης.
 Στη περίπτωση που δεν γίνει επικύρωση με το πλήκτρο «OK», η χρονική καθυστέρηση ρυθμίζεται από μόνη της σε 8 λεπτά και 30 δευτερόλεπτα.

	< 4 δ. >		
x 5		20 δ	OK
x 10		40 δ	OK
x 15		1 λ.	OK
x 30		2 λ.	OK
x 60		4 λ.	OK
x (X)		8 λ. 30 δ.	—

Προγραμματισμός για λειτουργία ποτενσιόμετρου από απόσταση (τηλεποτενσιόμετρο)

Επιλογή λειτουργίας

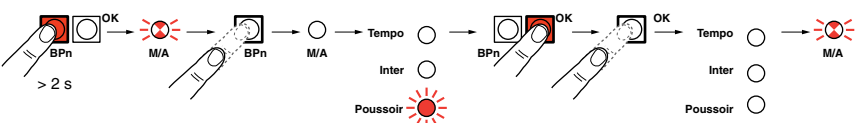

Προγραμματισμός κωδικού εκκίνησης/ντιμαρίσματος

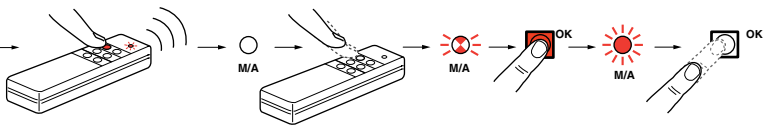

Σημαντικό:
 Μη χρησιμοποιείτε το ίδιο πλήκτρο τηλεχειρισμού ως κωδικό εκκίνησης/ντιμαρίσματος και ως κωδικό εκκίνησης/στάσης

Προγραμματισμός κωδικού εκκίνησης/σβήσιματος

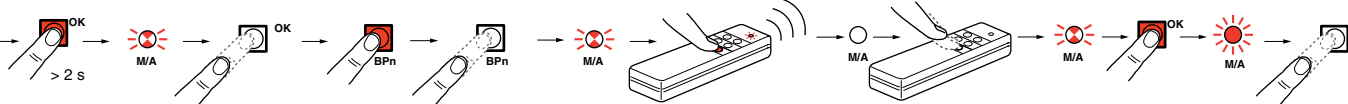

Λειτουργία

Εκκίνηση/ντιμαρίσμα

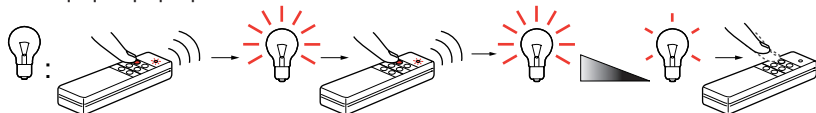

Εκκίνηση/σβήσιμο

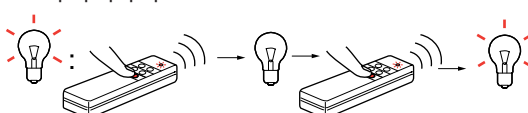

Διαγραφή κωδικών

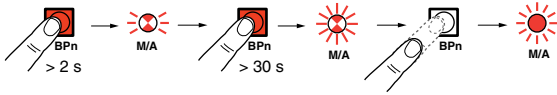



Σημαντικό:

Διαγραφή κωδικού έχει σαν αποτέλεσμα την απώλεια όλων των κωδικών μιας εξόδου.

Τοπική λειτουργία

Σε λειτουργία διακόπτη :  με σύντομα πατήματα < 2 δ., το ρελέ "n" κλείνει και στη συνέχεια ανοίγει διαδοχικά

Σε λειτουργία χρονοδιακόπτη :  με ένα σύντομο πάτημα < 2 δ. στο "BPn", το ρελέ "n" κλείνει για χρόνο τόσο όσο και η αντίστοιχη χρονική καθυστέρηση

Σε λειτουργία πιεζοδιακόπτη  ή τηλεπτενσιόμετρου, με πολύ σύντομο πάτημα < 0,4 δ. στο "BPn" κλείνει για 0,4 δ., με σύντομο πάτημα (> 0,4 δ., < 2 δ.) στο "BPn", το ρελέ "n" κλείνει περίπου για 4 δ.

Παράδειγμα καλωδίωσης με τηλεπτενσιόμετρο :

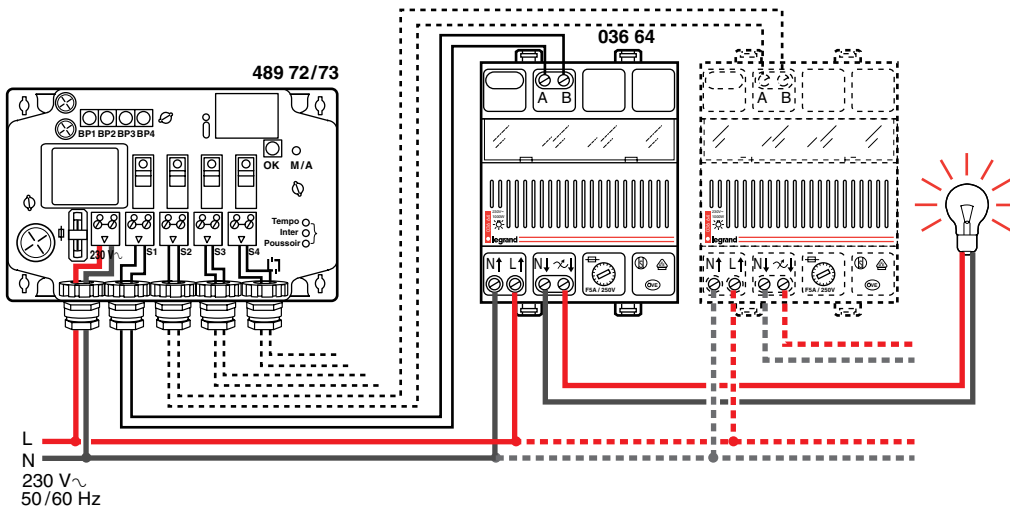
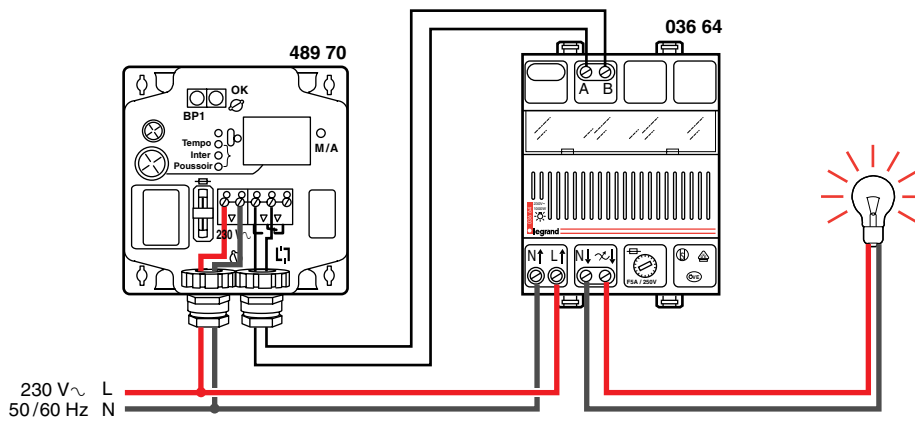

Plexo 55

CAD Radyo Alıcısı

489 70/72/73

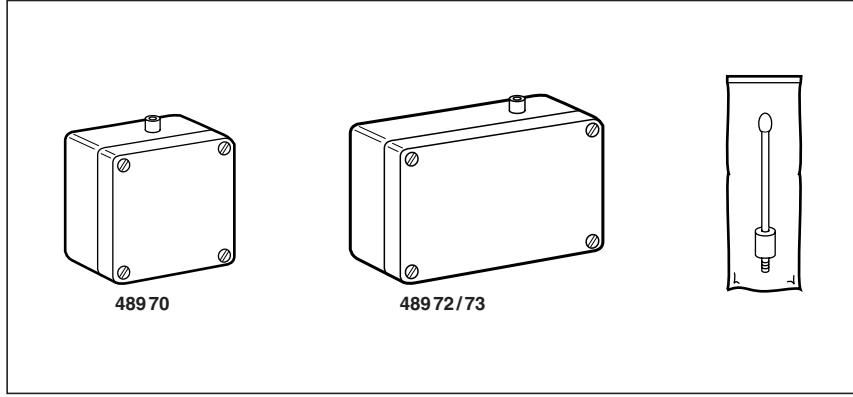

Teknik özellikler

U	230 V ~ - 50 / 60 Hz
F	433,92 MHz
I	14 mA
	32 mA - 250 V - 5 x 20 F
	-10 < < +55 °C

Kullanım

489 70	1800 W	1800 W		
489 72/73	8 A - 230 V ~	8 A - 230 V ~	1000 VA	

Uzaktan kumanda

Kullanılabilir vericiler						
	489 06 489 10 489 12	489 00 489 01 489 03	882 80	841 05 841 06 841 07	746 06 746 07	916 13
	489 70 / 72 / 73					

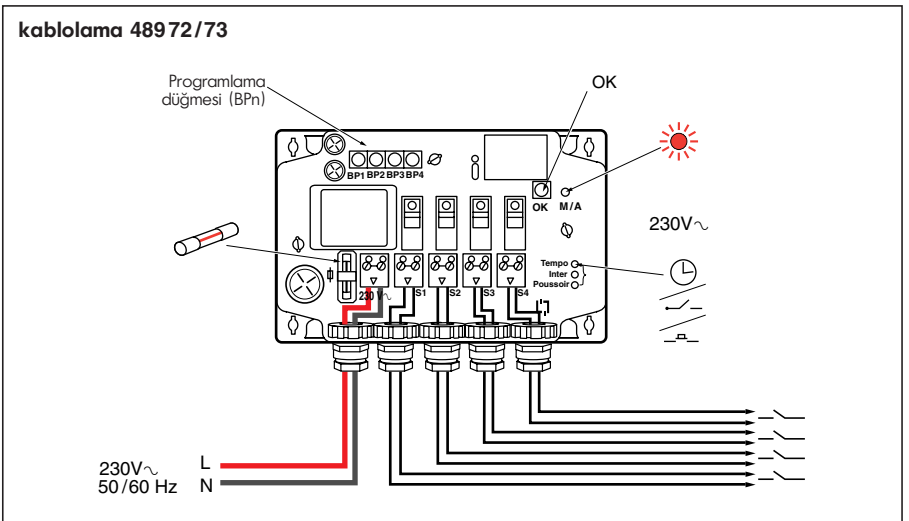
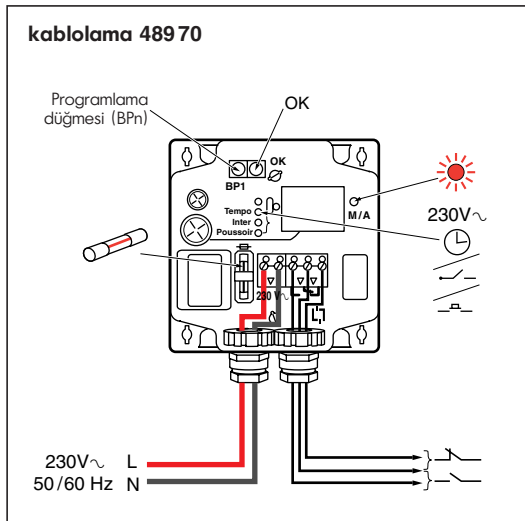
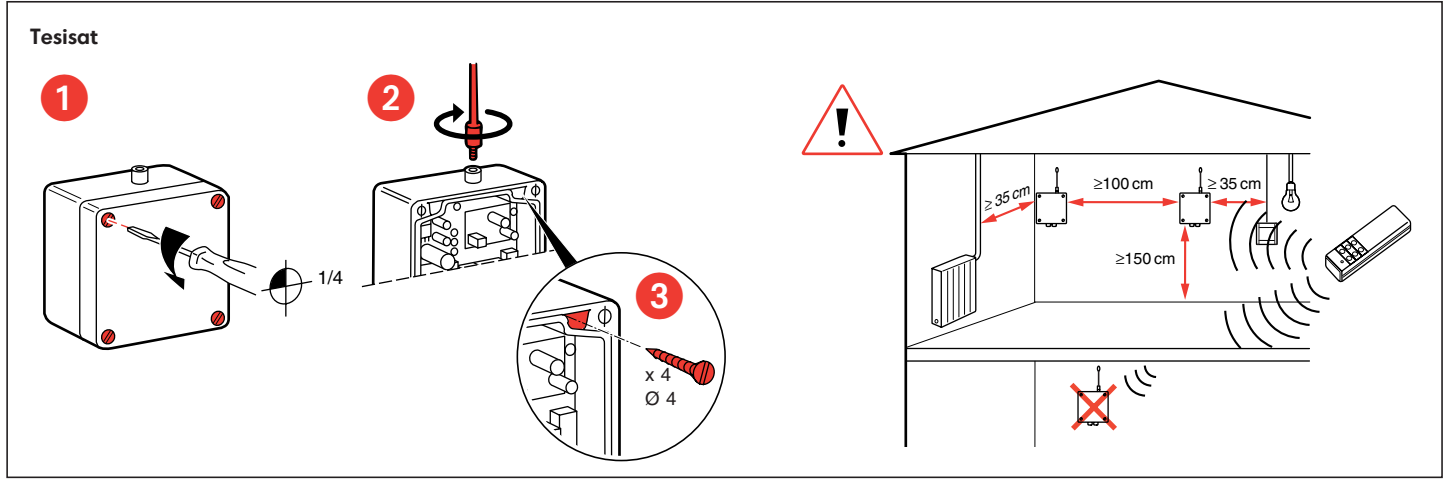

Bu ürün, her bir çıkış için 16 farklı Açık kodu ve 16 farklı Kapalı kodu taşır. Fakat, kullanma modlarında bileşim mümkün değildir. Zaman ayarlı anahtar, anahtar ve liht butonu işlevleri tek bir çıkışa yüklenmiş programlar için ayrıdır.

Önemli :

BPn düğmesine 2 saniyeden uzun basıldığında, M/A göstergesi program ayarlama durumuna geçtiğini göstermek için yanıp söner. Eğer düğme bırakıldıktan sonra, gösterge 3 defa çok çabuk yanıp sönerse, bu alıcıya daha fazla program girilemeyeceğini gösterir. Kullanıcının iki seçeneği vardır : ya başka bir vericiyi programlamaktan vazgeçmek ya da bütün programları silmek ve 16 yeni program girmek. Bir tuşa iki defa basma arasında geçen sürenin, 30 saniyeyi aşmamasına dikkat edin, aksi takdirde alıcı otomatik olarak ayarlama durumundan çıkacaktır.

Programlama sembolleri

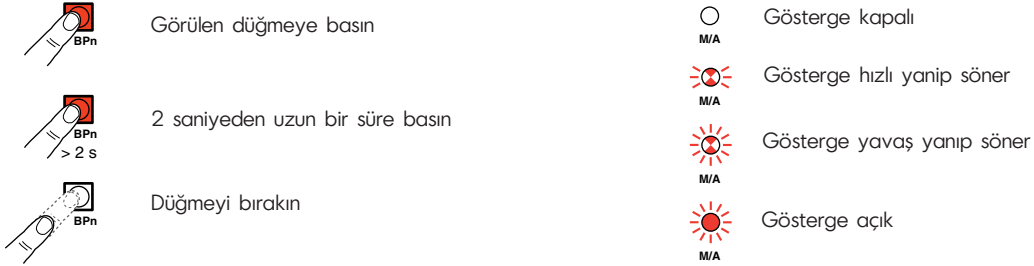

Kullanım şekillerinin seçimi

Zaman ayarlı anahtar olarak : $> 2 \text{ san}$ $< 8 \text{ dak } 30 \text{ san}$

Anahtar olarak :

Liht butonu olarak :

BPn tuşuna ardarda basılarak durum değiştirilebilir.

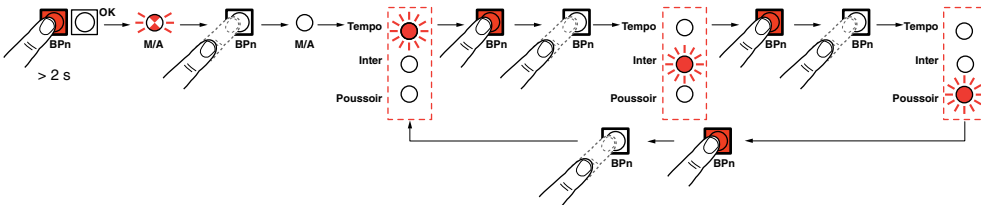

Anahtar olarak ayarlama

Önemli :

Bir alıcıyı, bir vericideki 2 farklı tuş üzerinden (anahtar olarak kullanma, A) ya da bir vericideki tek bir tuş üzerinden (uzaktan kumanda elektrik devresi olarak kullanma, B) kontrol etmek mümkündür. Fakat, eğer radyo parazit ortamı söz konusu ise, tercihen anahtarı olarak kullanınız.



Mod seçimi

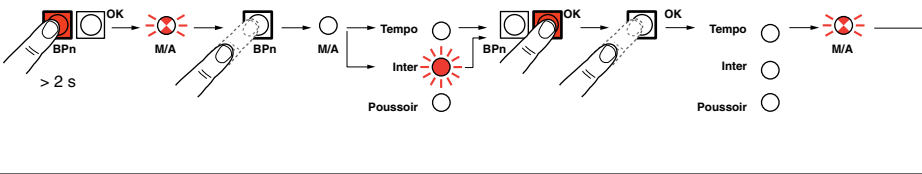

Açık kodu talimatı

Kapalı kodu talimatı

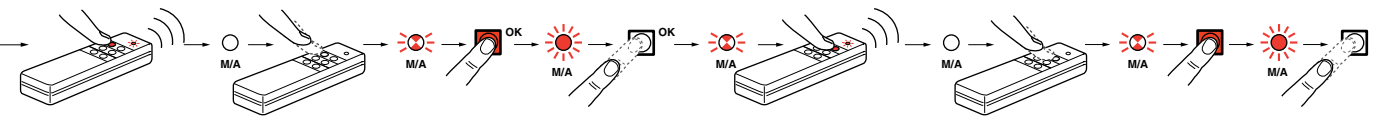

Tek bir Kapalı kodu talimatı

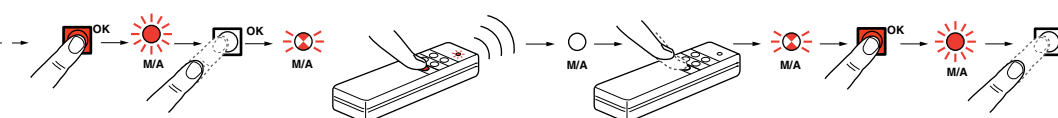

Birçok alıcıya tek bir Kapalı kodu talimatı verilmişse, elektrik devresinden genel kapatma olarak kullanılabilir.

Programların silinmesi

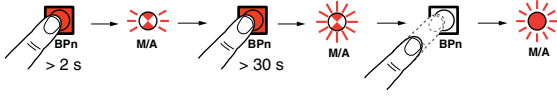

Önemli :

Programların silinmesi, bir çıkıştaki programların hepsinin silinmesine neden olur.

Ürün üzerinden kumanda

Anahtar olarak :  < 2s, 'lik kısa tuşlarla basın.
"n" rölesi kapanır ve daha sonra açılır

Zaman ayarlı anahtar olarak :  "BPn" üzerine <2 s.'lik kısa bir dokunma işlemi, "n" rölesi, ayarlanmış süre boyunca kapanır

Liht butonu olarak  veya televizyator modunda, "BPn" üzerinde <0,4 s.'lik çok kısa bir dokunma, "n" rölesi 0,4 s. boyunca kapanır. "BPn" üzerinde kısa süreli bir dokunma (>0,4 s., <2 s), "n" rölesi, yaklaşık olarak 4 s. boyunca kapanır.

Televizyator kablolu örneği :

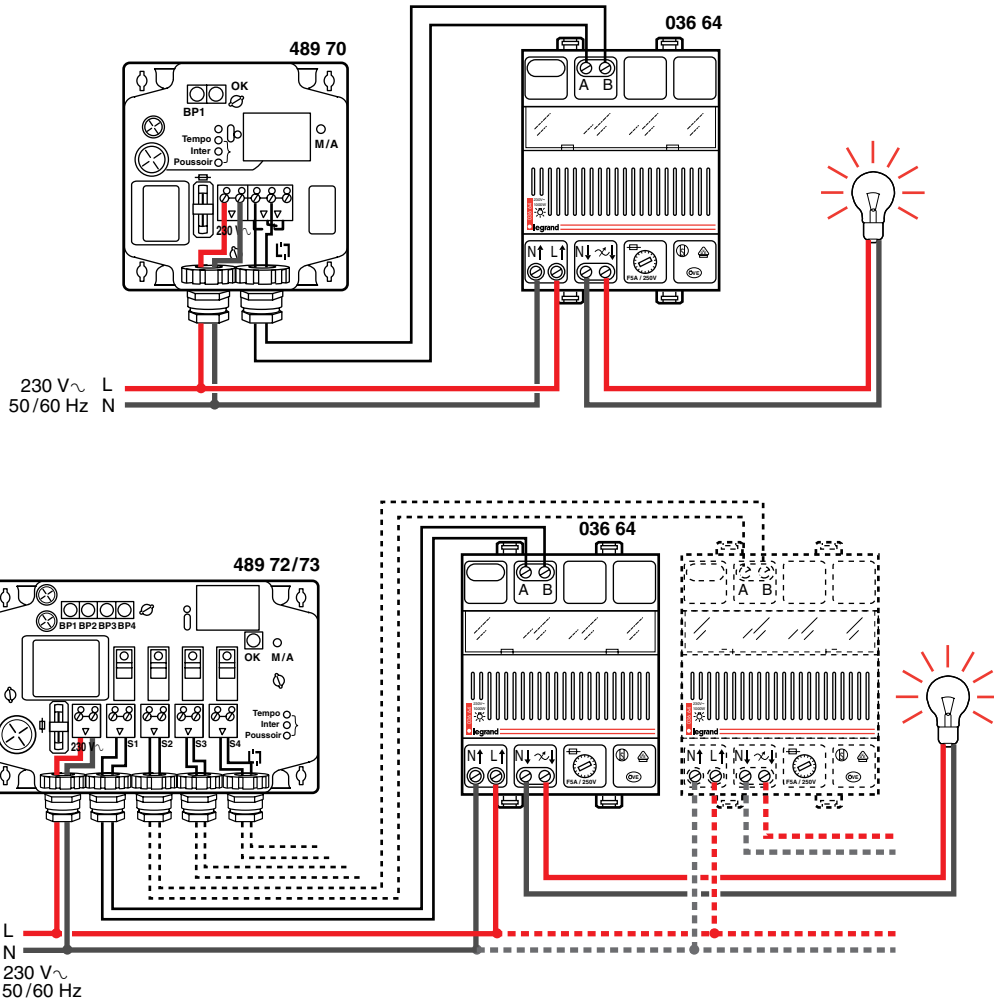

Plexo 55

CAD Rádiófrekvenciás vevő

489 70 / 72 / 73

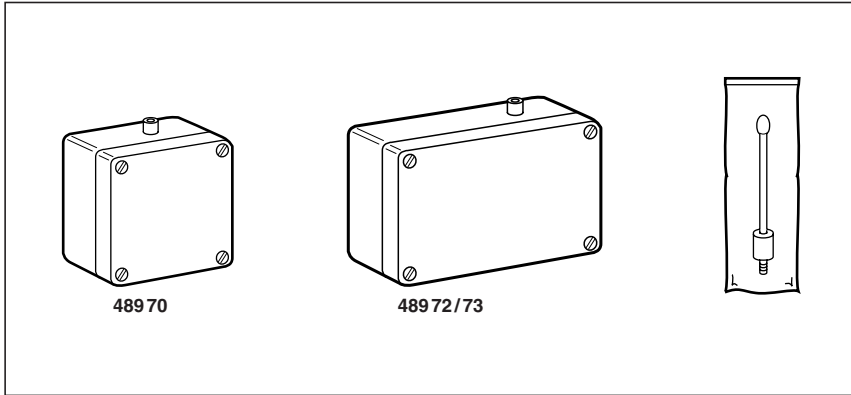

Műszaki adatok

U	230 V ~ - 50 / 60 Hz
F	433,92 MHz
I	14 mA
	32 mA - 250 V - 5 x 20 F
	-10 < < +55 °C

Felhasználás

489 70	1800 W	1800 W	1000 VA	
489 72/73	8 A - 230 V ~	8 A - 230 V ~	1000 VA	

Távműködtetési üzemmód

Távműködtetési						
	489 06 489 10 489 12	489 00 489 01 489 03	882 80	841 05 841 06 841 07	746 06 746 07	916 13
	489 70 / 72 / 73					

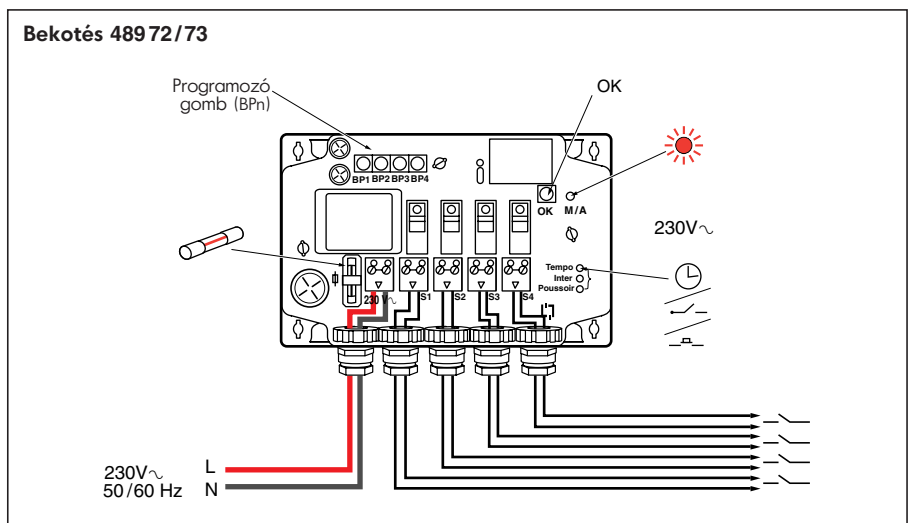
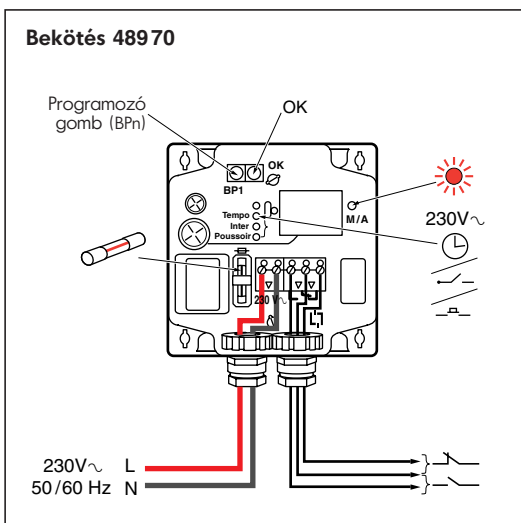
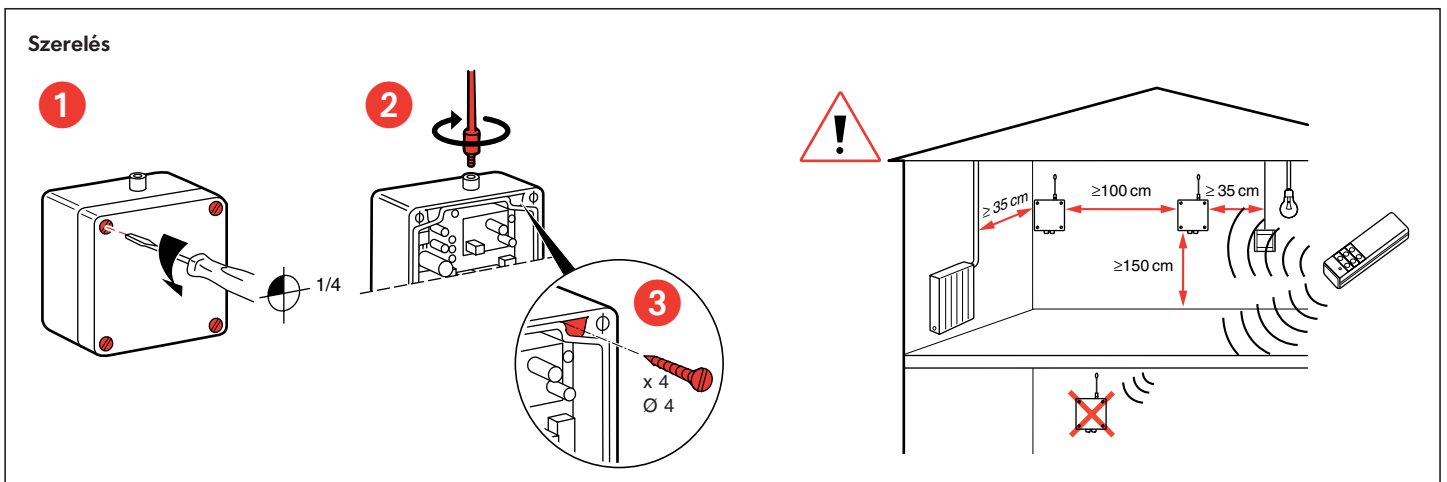







Ez a termék kimenetenként 16 különböző "Be" kód és 16 különböző "Ki" kód tárolására képes. Az üzemmódok kombinálására nincs lehetőség. Az időzítő, kapcsoló és nyomógomb üzemmódok az adott kimeneten tárolt összes kódra azonosak lesznek.

Fontos:

Ha az n. nyomógombot 2 másodpercnél hosszabb ideig lenyomva tartja, akkor az On/Off jelzőfény villogással jelzi, hogy a készülék programozási üzemmódba lépett. Ha az n. nyomógomb elengedése után a jelzőfény háromszor egymás után nagyon gyorsan felvillan, akkor ez azt jelzi, hogy a vevőegység már nem tud több kódot fogadni. A felhasználónak ilyenkor két lehetősége van: lemond a további adóegység programozásának szándékáról, vagy törli az összes kódot, és 16 új kódot programoz be.

Adott gomb két egymást követő lenyomása között ne hagyjon 30 másodpercnél hosszabb szünetet, különben a vevőegység automatikusan kilép a programozási üzemmódból.

A programozás jelzései

	Nyomja meg az adott nyomógombot		Az adott jelzőfény nem világít
	2 másodpercnél hosszabb ideig tartsa lenyomva		Az adott jelzőfény gyors ütemben villog
	Engedje el a nyomógombot		Az adott jelzőfény lassú ütemben villog
			Az adott jelzőfény világít

Üzemmód kiválasztása

Időzítő üzemmód : > 2 mp  < 8 perc 30 mp

Kapcsoló üzemmód : 

Nyomógomb üzemmód : 

Az üzemmód megváltoztatható a BPn nyomógomb ismételt lenyomásával.

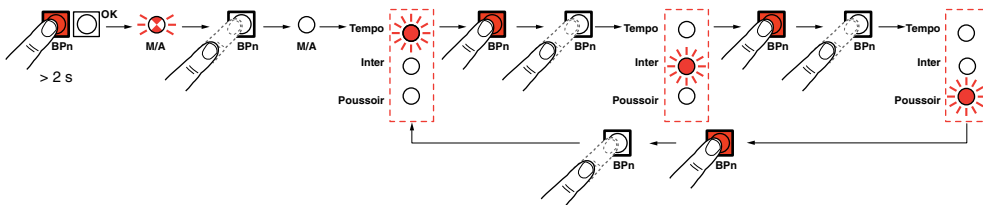

Kapcsoló üzemmód programozása 

Fontos:

A vevőegységet az adóegység 2 különböző billentyűjével (kapcsolóként használva, A) vagy egyetlen billentyűjével (távkapcsolóként, B) vezérelheti. Interferenciának kitett környezetben azonban előnyben kell részesíteni a kapcsolóként történő alkalmazást.

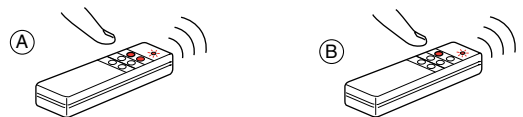

Üzemmód kiválasztása

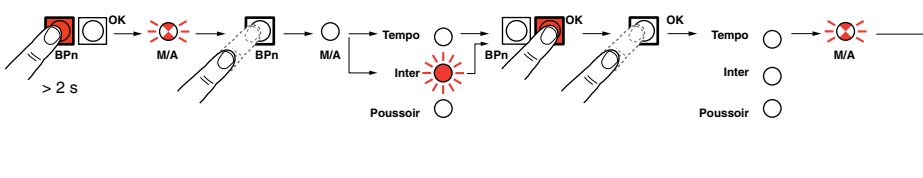

A "Be" kód programozása

A "Ki" kód tanítása

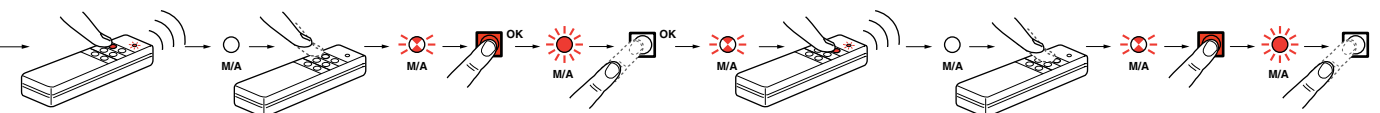

A "Ki" kód programozása



Ha több vevőegységet programoz be azonos "Ki" kódra, akkor ez általános kikapcsolás végrehajtására használható fel.

Nyomógomb üzemmód programozása

Üzemmód kiválasztása

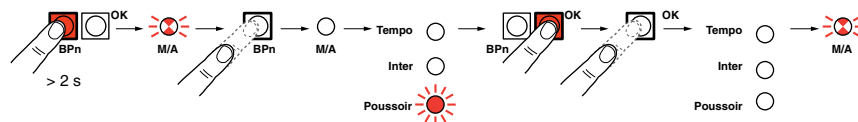

Kód programozása

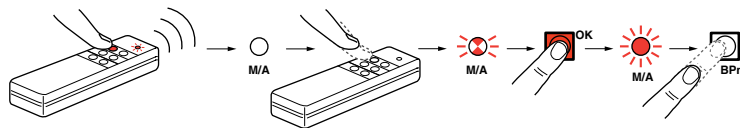

Idokapcsoló programozása üzemmód

Üzemmód kiválasztása

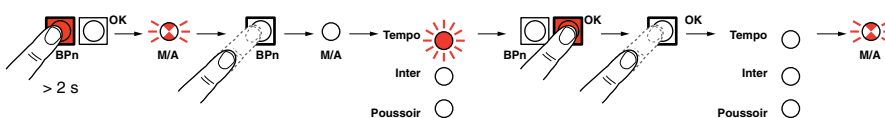

A "Be" kód programozása

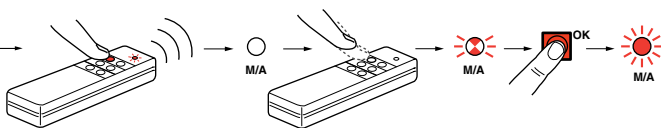

Késleltetés beállítása (> 2 mp < 8 perc 30 mp)

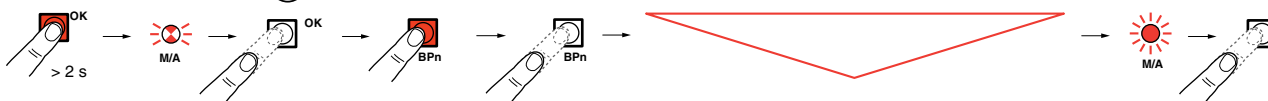

Megjegyzés:

Az On/Off jelzőfény 4 másodpercenként villan fel.
Példa: 1 perc = a jelzőfény tizenötször villan fel.
Hosszabb időtartam beállításához használjon stopperórát.
Ha a késleltetést nem erősíti meg az «OK» megnyomásával,
akkor az automatikusan 8 perc 30 másodpercre áll be.

< 4 s >		
x 5	20 s	OK
x 10	40 s	OK
x 15	1 mn	OK
x 30	2 mn	OK
x 60	4 mn	OK
x (X)	8 mn 30s	—

Távvezérelt fényerőszabályzás üzemmód programozása

Üzemmód kiválasztása

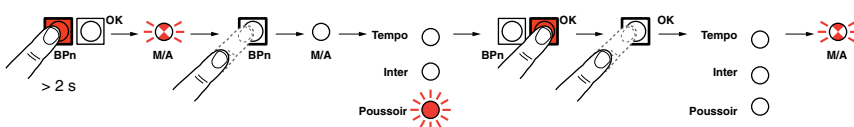

A bekapcsolási/szabályozási kód megtanítása

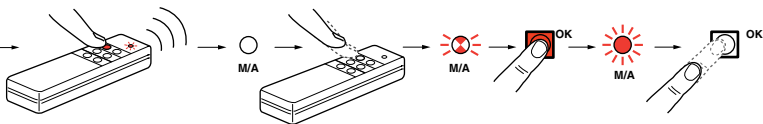

Fontos :
Ne használja a távm.ködtet. gombokat a bekapcsolási/szabályozási és a bekapcsolási/kikapcsolási kódokhoz.

A "Be"/"Ki" kód megtanítása

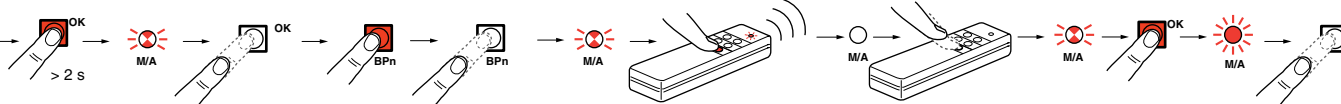

Működés

"Be"/"Fényerőszabályzás"

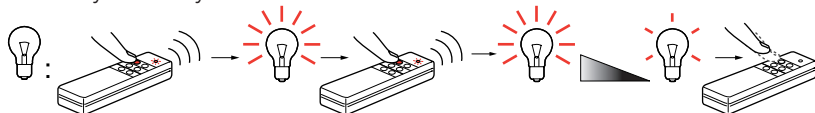

"Be"/"Ki"

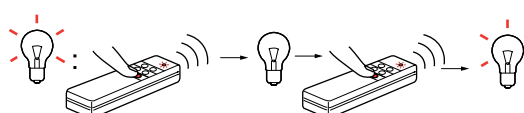

Kódok törlése

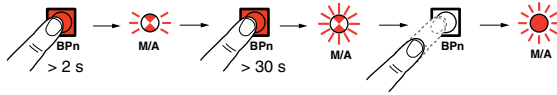

Fontos :

A kódok törlése az adott kimenetre vonatkozó összes kód elvesztésével jár.

Közvetlen működtetés

Kapcsoló üzemmód : — a nyomógomb rövid idejű (< 2s), megnyomására az "n" relé zárja majd nyitja az áramkört

Időzített kapcsdó üzemmód : — a "BPn" nyomógomb rövid idejű (< 2s) megnyomására az "n" relé zárja az áramkört a beállított időtartamra

Nyomógomb — távirányító fényerőszabályozó üzemmód : a "BPn" nyomógomb nagyon rövid idejű (< 0,4s) lenyomására az "n" relé zár 0,4s, időtartamra, 0,4s-nál hosszabb de 2s-nál rövidebb idejű megnyomására az "n"relé zár kb. 4s időtartamra.

Példa a távirányító fényerőszabályozó bekötésére :

